

430HD and 440HD IP Phones for Microsoft[®] Skype[™] for Business

Version 3.0.4



Microsoft Partner

Gold Communications

 Skype for Business

 audiocodes

Table of Contents

1	Introducing the 430HD and 440HD IP Phone	11
1.1	About AudioCodes' Series of High Definition IP Phones	11
1.2	Cutting Edge Voice Quality & HD VoIP	11
2	Setting up the Phone.....	13
2.1	Unpacking.....	13
2.2	Device Description	13
2.2.1	Front View.....	13
2.2.2	Rear View	15
2.3	Cabling.....	16
2.4	Mounting the Phone.....	17
2.4.1	Desktop Mounting.....	17
2.4.1.1	Routing the Handset Cable	17
2.4.2	Wall Mounting	17
3	Getting Started.....	19
3.1	Getting Acquainted with the Phone Screen	19
3.2	Softkeys.....	20
3.3	Navigating the Phone Menu	21
3.4	Selecting an Alphanumerical Mode	22
4	Signing In	25
4.1	Signing in with PIN Code	25
4.2	Signing in with User Name and Password.....	26
4.3	Signing in with the Web Cloud (Office 365) Option.....	27
4.4	Signing in using the Web Login Option.....	27
4.5	Signing in as a Common Area Phone (CAP) User	28
4.6	Signing Out	30
4.6.1	Signing out if the 'Sign out' Softkey is Removed from the Screen	31
4.7	Hot Desking	33
4.8	Displayed Messages.....	34
5	Unlocking a Locked Phone.....	35
5.1	Dialing Emergency Numbers if the Phone is Locked.....	37
5.2	Using Other Functionalities if the Phone is Locked	37
6	Customizing Your Phone.....	39
6.1	Changing the Screen Language.....	39
6.2	Selecting Ring Tone.....	40
6.3	Enabling Call Waiting	41
6.4	Managing Simultaneous Incoming Calls.....	41
6.4.1	Configuring Busy on Busy	42
6.5	Defining Call Forwarding.....	43
6.6	Setting Date and Time	44
6.7	Changing Screen Contrast Level.....	46
6.8	Defining BLF LCD Contrast.....	47
6.9	Defining Screen's Backlight Timeout.....	48
6.10	Selecting an Answering Device.....	49
6.11	Defining Location	50
6.12	Defining an Outbound Proxy	51
6.13	Adjusting Volume	52
6.13.1	Adjusting Ring Volume.....	52

- 6.13.2 Adjusting Tones Volume52
- 6.13.3 Adjusting Handset Volume52
- 6.13.4 Adjusting Speaker Volume53
- 6.13.5 Adjusting Headset Volume53
- 6.14 Managing Phone Directories 54
 - 6.14.1 Accessing Directories54
 - 6.14.2 Adding a Contact to the Personal Directory55
 - 6.14.3 Editing Contact Information in the Personal Directory.....56
 - 6.14.4 Deleting a Contact from the Personal Directory57
 - 6.14.5 Adding a Person to Favorites after a Call with them is Logged.....58
 - 6.14.6 Removing a Person from Favorites59
 - 6.14.7 Searching for a Contact in a Directory.....60
- 6.15 Searching for a Contact in the Corporate Directory using T9..... 61
 - 6.15.1 Changing from T9 to A/a/1.....61
- 6.16 Defining Function Keys as Speed Dials..... 62
 - 6.16.1 Configuring Pause Dialing for a Speed Dial to an Ext. behind an IVR63
 - 6.16.2 Editing a Speed Dial64
 - 6.16.3 Deleting the Speed Dial65
- 6.17 Defining Function Keys as Paging Dials..... 66
- 6.18 Defining Programmable Keys as Speed Dials 68
 - 6.18.1 Deleting the Speed Dial69
- 6.19 Defining Programmable Keys as Paging Dials 70
- 6.20 Defining Programmable Keys as Key Events 72
 - 6.20.1 Defining Programmable Key #6 as a VocaNOM Speed Dial73
 - 6.20.2 Deleting a Key Event74
- 6.21 Changing your Presence Status..... 75
- 6.22 Viewing Microsoft Exchange Calendar in the Phone Screen 76
- 6.23 Receiving Meeting Reminders 77
- 7 Performing Basic Operations 79**
 - 7.1 Using Audio Devices 79
 - 7.2 Checking Voice Quality 79
 - 7.3 Making Calls 79
 - 7.3.1 Dialing80
 - 7.3.2 Redialing81
 - 7.3.3 Dialing a Missed Call81
 - 7.4 Answering Calls 82
 - 7.5 Rejecting Incoming Calls..... 83
 - 7.6 Silencing Incoming Calls 84
 - 7.7 Making a New Call Even Though a Call is Coming in..... 84
 - 7.8 Ending an Established Call 84
 - 7.9 Viewing Missed, Received and Dialed Calls..... 85
 - 7.10 Reporting a Malicious Call..... 87
 - 7.11 Paging..... 87
 - 7.11.1 Performing Outgoing Paging Calls 87
 - 7.11.2 Receiving Incoming Paging Calls 87
- 8 Performing Advanced Operations 89**
 - 8.1 Answering Waiting Calls 89
 - 8.2 Placing Calls On Hold 90
 - 8.3 Handling Multiple Incoming Calls 90
 - 8.4 Calling a Contact from 'Favorites' 91
 - 8.5 Using a Speed Dial to Call 92
 - 8.6 Transferring Calls..... 93

8.6.1	Performing a Blind Transfer.....	93
8.6.2	Performing a Consultation Transfer.....	94
8.6.3	Performing a Semi-Consultative Transfer.....	95
8.6.4	Merging Calls.....	96
8.7	Parking a Call.....	97
8.8	Configuring Group Call Pickup (GCP).....	97
8.9	Initiating a Multi-Party Skype for Business Remote Conference.....	98
8.10	Muting Calls.....	101
8.1	Setting up Better Together over Ethernet.....	102
8.1.1	Installing the BToE PC/Laptop Application.....	102
8.1.2	Making Sure BToE is Correctly Installed.....	110
8.1.3	Configuring the BToE TCP Port.....	110
8.1.4	Enabling BToE for Online Users.....	111
8.1.5	Automatically Pairing the BToE PC/Laptop Application with the IP Phone.....	111
8.1.6	Manually Pairing the BToE PC/Laptop Application with the IP Phone.....	112
8.1.6.1	Manually Generating a Pair Code.....	112
8.1.6.2	Manually Connecting the IP Phone with the BToE PC/Laptop Application.....	113
8.1.6.3	Connecting the Skype for Business Client with the IP Phone.....	116
8.1.7	Making Sure IP Phone/ Skype for Business Client are Paired.....	116
8.1.7.1	Making Sure Skype for Business Client is Paired.....	116
8.1.7.2	Making Sure the IP Phone is Paired.....	117
8.2	Using BToE Functions.....	118
8.2.1	Signing in to the Phone from the Skype for Business Client.....	118
8.2.2	Making a Call (Click-to-Dial).....	119
8.2.3	Answering a Call.....	119
8.2.4	Establishing a Unified Communications Call Conference.....	121
8.2.5	Transferring a Call.....	123
8.2.6	Switching the Primary Audio Device.....	123
8.2.7	Routing Voice from a Video Call to the Phone.....	125
8.3	Using the Boss Admin Feature.....	126
8.3.1	Viewing who the Admins are on the Boss' Phone.....	126
8.3.2	Viewing who the Bosses are on the Admin's Phone.....	127
8.3.3	Viewing Bosses and Admins.....	128
8.3.4	Handling an Incoming Call for the Boss.....	128
8.3.5	Calling on Behalf of the Boss.....	128
8.3.5.1	Using Boss' Line Key.....	129
8.3.5.2	Keying in the Destination Phone Number.....	130
8.3.5.3	Pressing the CONTACTS Key.....	131
8.3.6	Answering a Call on Boss' Phone.....	131
8.3.7	Redirecting an Established Call to Boss' Voicemail.....	132
8.3.8	Redirecting an Incoming Call to Boss' Voicemail.....	132
8.3.9	Admin Handing Off a Call to Boss.....	133
8.3.10	Boss Handing Off a Call to Admin.....	133
8.3.11	Boss Monitoring Admins, Seizing a Call Put on Hold by an Admin.....	134
8.3.12	Admin Picks up a Call from Boss.....	134
8.3.13	Admin 1 Picks up a Call from Admin 2.....	134
8.3.14	Admin's Phone Notifies Recipient that Admin's Call is on Behalf of Admin's Boss.....	135
8.3.15	Admin Calling Boss, Admin Calling a Recipient on Behalf of Boss.....	135
8.4	Using the Multiple Boss Admin Feature with the 440HD Sidecar.....	136
8.4.1	Displaying a Boss's or an Admin's Active Calls in the Sidecar.....	136
8.4.2	Boss Picking up a Call that Admin Put on Hold.....	138
8.5	Viewing and Playing Voicemail Messages.....	139
8.5.1	Sending an Incoming Call Directly to Voicemail.....	140
9	Managing Calls on 2+ Phones with a Delegated Line, Using Sidecars.....	141
10	Troubleshooting.....	145
10.1	Uploading Logs to MS Server for Support Purposes.....	145

List of Figures

Figure 2-1: Front View	14
Figure 2-2: Rear View.....	15
Figure 2-3: Cabling	16
Figure 3-1: Phone Screen in Idle State	19
Figure 3-2: Phone Menu	21
Figure 3-3: Alphanumerical Selection.....	22
Figure 3-4: Entering a Symbol (e.g., a dot)	23
Figure 3-5: Reverting to Letters (e.g., abc).....	23
Figure 4-1: Login.....	31
Figure 4-2: Web Interface – Home Page.....	31
Figure 4-3: Sign-in – Content Blocked Page	32
Figure 4-4: Sign-in – Windows Security Prompt.....	32
Figure 4-5: Windows Security Prompt.....	33
Figure 4-6: Sign-out.....	33
Figure 8-1: InstallShield Wizard – Preparing to Install	103
Figure 8-2: Welcome to the InstallShield Wizard	103
Figure 8-3: License Agreement	104
Figure 8-4: License Agreement	104
Figure 8-5: Destination Folder	105
Figure 8-6: Change Current Destination Folder	105
Figure 8-7: Ready to Install	106
Figure 8-8: Installing AudioCodes Better2Gether.....	106
Figure 8-9: InstallShield Wizard Completed	107
Figure 8-10: AudioCodes Icon in Taskbar	107
Figure 8-11: Control Panel>Programs>AudioCodes Better2Gether	108
Figure 8-12: Computer Management > Services and Applications.....	108
Figure 8-13: Device Manager > AudioCodes B2GoE USB Driver	109
Figure 8-14: Popup Menu	110
Figure 8-15: About AC BToE	110
Figure 8-16: TCP Port.....	110
Figure 8-17: AC BToE TCP Port	111
Figure 8-18: Popup Menu	113
Figure 8-19: Phone Pairing.....	113
Figure 8-20: AC BToE Failed Indication.....	113
Figure 8-21: AC BToE is Connected Indication.....	113
Figure 8-22: Popup Menu: 'Disconnect' Enabled, 'Phone Pairing' Disabled	114
Figure 8-23: BToE Disconnected	114
Figure 8-24: Popup Menu: BToE Disconnected.....	114
Figure 8-25: Start > Programs > AudioCodes > BToE Controller	115
Figure 8-26: Skype for Business Sign-in Request Prompt.....	116
Figure 8-27: Primary Device: IP Phone	123
Figure 8-28: Primary Device: Headset	124
Figure 8-29: Primary Device: Speaker	124

List of Tables

Table 2-1: Front View Description	14
Table 2-2: Rear View Description	15
Table 3-1: Phone Screen in Idle State.....	19
Table 3-2: Softkeys.....	20
Table 4-1: Displayed Messages Indicating Processes In Progress	34
Table 6-1: Time Zones.....	45
Table 6-2: Presence Statuses	75
Table 8-1: Multiple Boss Admin.....	136
Table 9-1: Phone Screen in Idle Mode and Sidecar BLF Keys and Fields	141
Table 9-2: Phone A: Answered Incoming Call on Phone A.....	142
Table 9-3: Phone B: Answered Incoming Call on Phone A.....	142
Table 9-4: New Incoming Call	143
Table 9-5: Answered New Incoming Call	143
Table 9-6: Phone B: Answered New Incoming Call	144
Table 9-7: Phone B: Two Red BLF Keys.....	144
Table 10-1: Troubleshooting.....	145

This page is intentionally left blank.

Notice

Information contained in this document is believed to be accurate and reliable at the time of printing. However, due to ongoing product improvements and revisions, AudioCodes cannot guarantee accuracy of printed material after the Date Published nor can it accept responsibility for errors or omissions. Updates to this document can be downloaded from <https://www.audiocodes.com/library/technical-documents>.

This document is subject to change without notice.

Date Published: Feb-14-2018

Trademarks

AudioCodes Ltd. All rights reserved. AudioCodes, AC, HD VoIP, HD VoIP Sounds Better, IPmedia, Mediant, MediaPack, What's Inside Matters, OSN, SmartTAP, VMAS, VoIPerfect, VoIPerfectHD, Your Gateway To VoIP, 3GX, VocaNom, AudioCodes One Voice and CloudBond are trademarks or registered trademarks of AudioCodes Limited All other products or trademarks are property of their respective owners. Product specifications are subject to change without notice.

WEEE EU Directive

Pursuant to the WEEE EU Directive, electronic and electrical waste must not be disposed of with unsorted waste. Please contact your local recycling authority for disposal of this product.

Customer Support

Customer technical support and services are provided by AudioCodes or by an authorized AudioCodes Service Partner. For more information on how to buy technical support for AudioCodes products and for contact information, please visit our Web site at www.audiocodes.com/support.

Abbreviations and Terminology

Each abbreviation, unless widely used, is spelled out in full when first used.

Documentation Feedback

AudioCodes continually strives to produce high quality documentation. If you have any comments (suggestions or errors) regarding this document, please fill out the Documentation Feedback form on our Web site at <http://online.audiocodes.com/documentation-feedback>.

Related Documentation

Document Name
400HD Series IP Phones for Microsoft Skype for Business Release Notes
400HD Series IP Phones for Microsoft Skype for Business Administrator's Manual
430HD IP Phone for Microsoft Skype for Business Quick Guide
440HD IP Phone for Microsoft Skype for Business Quick Guide
400HD Series IP Phones for Skype for Business Hosting Partner (LHPv2) Environment Configuration Note

1 Introducing the 430HD and 440HD IP Phone

AudioCodes' 430HD and 440HD IP Phones for Microsoft Skype for Business are based on AudioCodes High Definition voice technology, providing clarity and a rich audio experience in Voice-over-IP (VoIP) calls.



Note: Microsoft rebranded *Lync* as *Skype for Business* so whenever the term *Skype for Business* appears in this document, it applies also to *Lync*.

The phone is a 1-line, 2 concurrent calls per line, premium model which includes a large monochrome multi-language graphic Liquid Crystal Display (LCD).

The phone is a fully-featured telephone that provides voice communication over an IP network, allowing you to place and receive phone calls, put calls on hold, transfer calls, make conference calls, etc.

Read this *User's Manual* carefully to learn how to operate the product and take advantage of its rich feature set.

1.1 About AudioCodes' Series of High Definition IP Phones

AudioCodes Series of High Definition IP Phones offers a new dimension of voice call quality and clarity for the IP Telephony market. This new series of IP Phones further expands AudioCodes' VoIP product offering for the service providers' hosted services, Enterprise IP telephony and Enterprise contact centers markets. As a natural addition to the AudioCodes Mobile Clients, Media Gateway, Media Server & Multi-Service Business Gateway products, the AudioCodes Series of High Definition IP Phones enable Systems Integrators and end-customers to build end-to-end solutions that rely on AudioCodes' technological advantage and proven track record in providing state-of-the-art products. The AudioCodes Series of High Definition IP Phones meet a growing demand for High Definition VoIP solutions in end-user phones and terminals, improving the productivity and efficiency of business communications with new quality standards set by the High Definition voice technology.

1.2 Cutting Edge Voice Quality & HD VoIP

Based on AudioCodes' advanced, robust and field-proven VoIPerfectHD™ software, AudioCodes' IP Phones are designed to utilize wideband coders. The phones feature enhanced proprietary capabilities such as packet loss concealment, high quality wideband acoustic echo canceler, and low-delay adaptive jitter buffers to enrich the HDVoIP experience.

This page is intentionally left blank.

2 Setting up the Phone

2.1 Unpacking

When unpacking, ensure that the following items are present and undamaged:

IP Phone / Stand

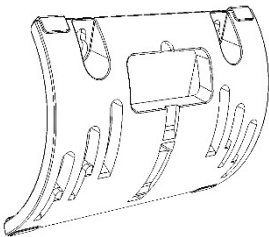
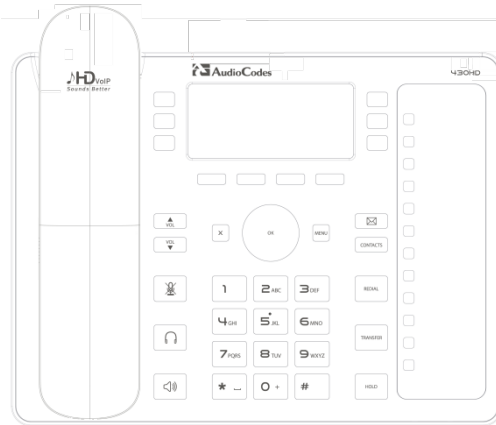

Handset / Cord



Cat 5e Ethernet Cable

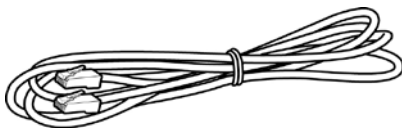

AC Power Adapter (Optional)



If anything appears to be missing or broken, contact the distributor from whom you purchased the phone for assistance.

2.2 Device Description

Use the graphics below to identify and familiarize yourself with the device's hardware functions.

2.2.1 Front View

The front view of the phone is shown in [Figure 2-1](#) and described in [Table 2-1](#).

Figure 2-1: Front View

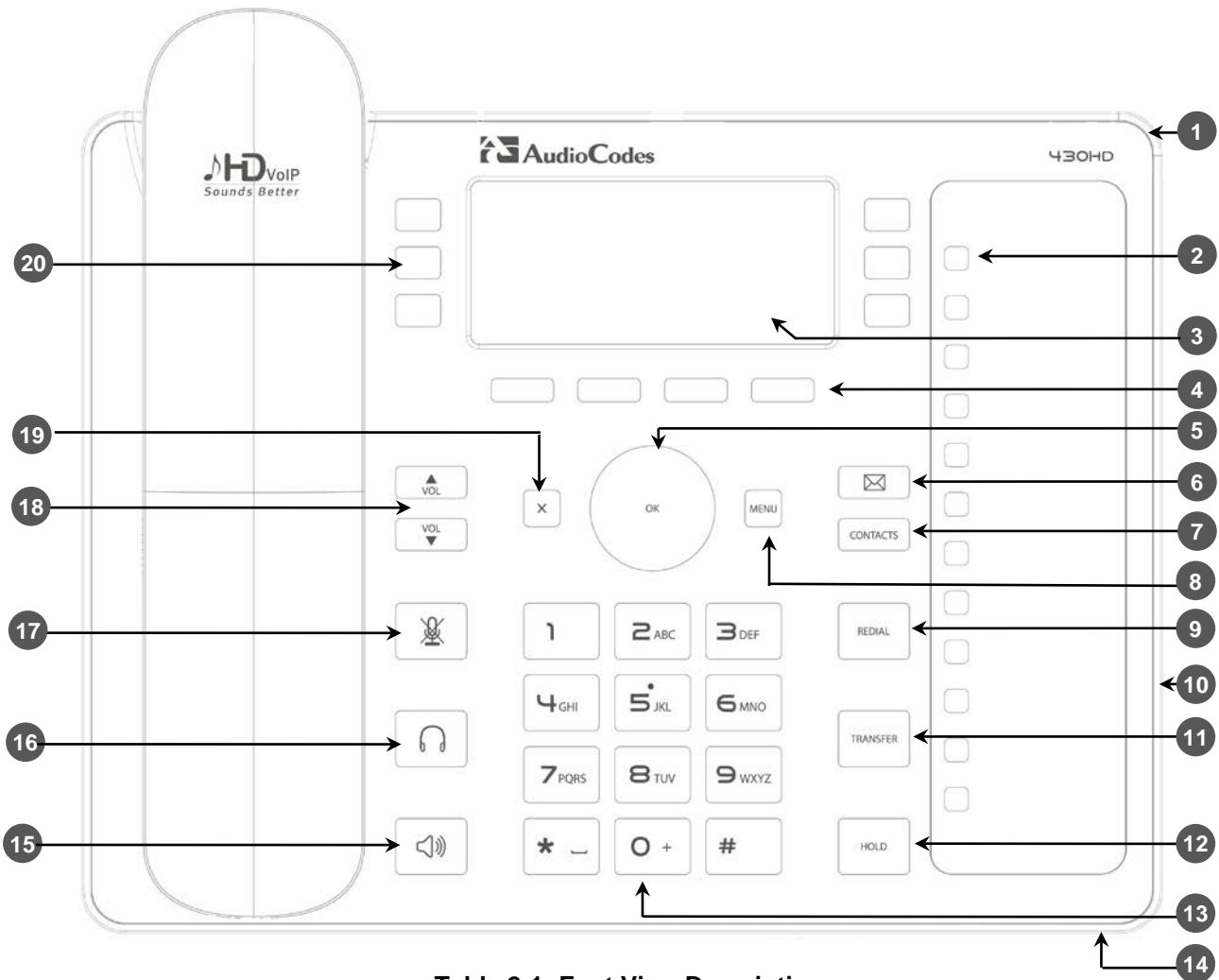

Table 2-1: Front View Description

Item #	Label/Name	Description
1	Ring LED	Flashing blue light visually indicates an incoming call.
2	Speed Dial & BLF	Twelve Speed Dial buttons to quickly call the contact whose name is displayed adjacent to it. You can configure these speed dial buttons with Busy Lamp Field (BLF) functionality. On the 440HD phone, a dedicated electronic screen displays contacts' names. On the 430HD phone, you can attach to a paper strip handwritten contacts' names.
3	Screen	Interactive screen displaying calling information and letting you configure phone features.
4	Softkeys	See Section 3.2 for details on the four softkeys and the available functions they offer.
5	Navigation Control / OK	Press the upper rim to scroll up menus/items in the screen. Press its lower rim to scroll down. Press its left or right rim to move the cursor left or right (when editing a contact number for example). Press the OK button to select a menu/item/option.
6	Voicemail	Retrieves voicemail messages.
7	CONTACTS	Press to directly access the 'Favorites' directory. Other directories can be accessed from the 'Favorites' screen.
8	MENU	Accesses menus: (1) Call Log (2) Calendar (3) Keys Configuration (4) Settings (5) Device Status (6) Administration (7) Favorites (8) Log upload.
9	REDIAL	Accesses a list of recently dialed numbers; one can be selected to redial.

Item #	Label/Name	Description
10	Kensington lock	Allows locking the device.
11	TRANSFER	Transfers a call.
12	HOLD	Places an active call on hold.
13	Alphanumerical Keypad	Keys for entering numbers, alphabetical letters and symbols (e.g., colons)
14	Microphone	Allows talking and listening. Network administrators can disable it if required.
15	SPEAKER	Activates the speakerphone, allowing a hands-free conversation.
16	HEADSET	Activates a call using an external headset.
17	MUTE	Mutes a call.
18	▲ VOL ▼ VOL	Increases or decreases the volume of the handset, headset, speakerphone, ring tone and call progress tones.
19	x	Cancel an action, such as dialing a number, after beginning it.
20	---	Programmable keys, located on each side of the screen, to which you can assign functions.

2.2.2 Rear View

The rear view of the phone is shown in the figure below and described in the table below.

Figure 2-2: Rear View

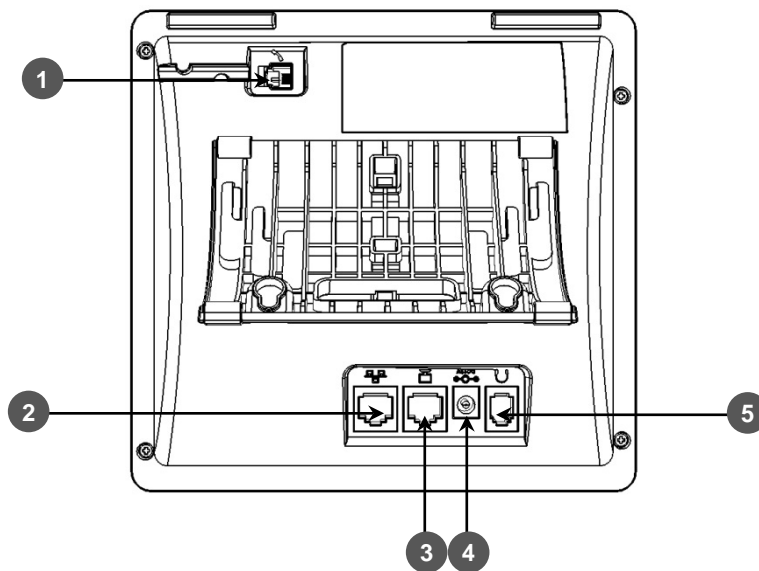

Table 2-2: Rear View Description

#	Label	Description
1		Handset jack, i.e., RJ-9 port, to connect the handset.
2		RJ-45 port to connect to the Ethernet LAN cable for the LAN connection (uplink - 10/100/1000 Mbps). If you're using Power over Ethernet (PoE), power to the phone is supplied from the Ethernet cable (draws power from either a spare line or signal line).
3		RJ-45 port to connect the phone to a PC (10/100/1000 Mbps downlink).
4	 DC12V	12V DC power jack that connects to the AC power adapter.
5		Headset jack, i.e., RJ-9 port that connects to an external headset.

2.3 Cabling

This section shows how to cable your phone.

Figure 2-3: Cabling

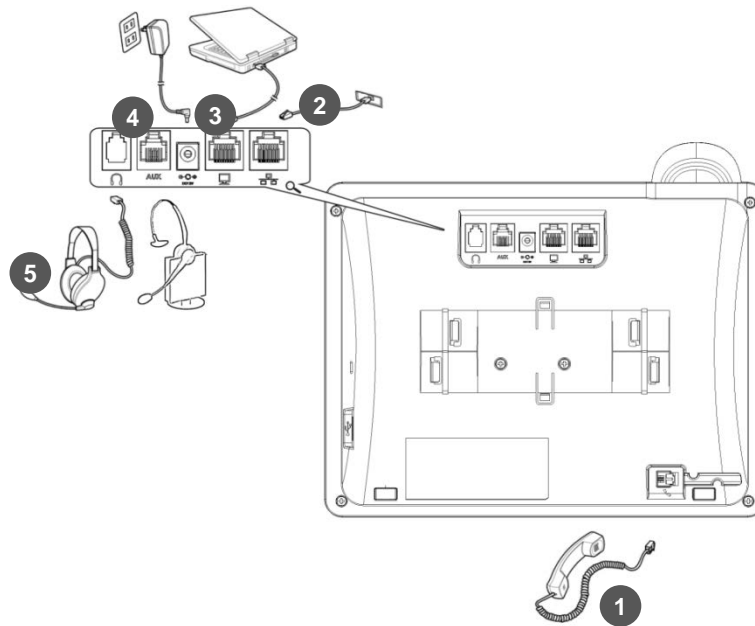

Action	Description
1	Connect the <i>short, straight end of the cord</i> to the handset. Connect the <i>longer, straight end</i> to the jack (RJ-9 port, for the handset) on the phone.
2	Connect the RJ-45 LAN port to your LAN network (LAN port or LAN switch/router), using a CAT 5 / 5e Ethernet cable
3	Connect the RJ-45 PC port to a computer, using a CAT 5 / 5e straight-through Ethernet cable
4	Connect the connector tip of the AC power adapter to the phone's power socket (labelled DC 12V). Connect the two-prong AC adapter directly to the electrical wall outlet. When the phone powers up, all the LEDs momentarily light up
5	Connect the RJ-9 headset jack to a headset (optional)



Note: If the LAN to which the phone is connected supports Power over Ethernet (PoE), no AC adapter is required; the phone receives power from the Ethernet network.



Prior to connecting power, refer to the Compliancy and Regulatory Information at www.audiocodes.com/library.

2.4 Mounting the Phone

The phone can be mounted on a:

- Desk (see Section 2.4.1 below)
- Wall (see Section 2.4.2 below)

See also <https://www.youtube.com/watch?v=oGe9STB9IFE> to assemble the base stand.

2.4.1 Desktop Mounting

This section shows how to place the phone on a desk or flat surface.

➤ **To mount the phone on a desk or flat surface:**

1. Off-hook the handset (if on-hook) and place the phone upside down, i.e., base-up, on your desktop.
2. On the phone's base, identify outer rails.
3. On the phone's stand, identify outer notches.
4. Invert the stand and align its outer notches with the base's outer rails.
5. Insert the stand's outer notches into the base's outer rails and slide the notches along the rails until the stand click-locks into the base.
6. Revert the phone and stand it on the desktop.

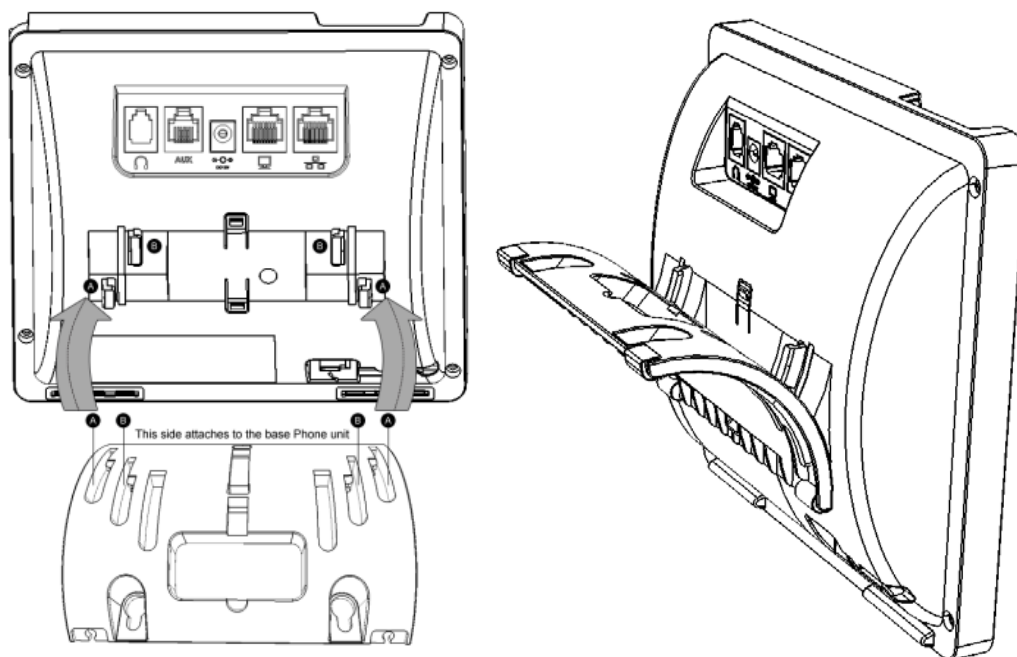

2.4.1.1 Routing the Handset Cable

The phone features a groove for routing the handset cable.

2.4.2 Wall Mounting

This section shows how to mount the phone on a wall.

➤ **To mount the phone on a wall:**

1. Attach the stand of the phone for the purpose of a wall mounting:
 - a. Detach the base.

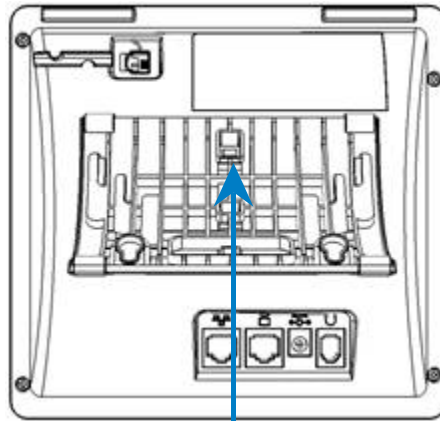

To detach the phone's stand, push this button

- b. Attach it again as you did for a desktop mounting (see Section 2.4.1) only now make sure that it's flatly aligned to lie flush against the wall, i.e., slide the *inner rails* of the phone stand onto the phone base's inner notches.

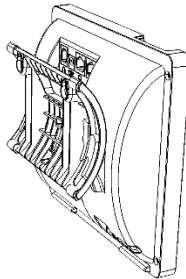

2. Connect the AC power adapter, LAN and PC cords.
3. In the wall, drill two horizontal holes at a distance of 3 15/16 inches (100 mm) from one another, in line with the template.
4. Insert two masonry anchors into the holes if necessary.
5. Thread two screws (not supplied) into the two masonry anchors; ensure that the heads extend sufficiently (about 3/16 inch or 5 mm from the wall) for the phone stand's keyhole slots to hang on.
6. Hang the phone stand's keyhole slots on these screws.

3 Getting Started

This section gets you started with the phone. The phone features a screen providing an intuitive, menu-driven user interface for configuring the device and viewing call information.

This section shows how to use the phone's screen but before using it, you must sign in.

3.1 Getting Acquainted with the Phone Screen

This section gets you acquainted with the phone screen.



Note:

- Screenshots of the 440HD screen are shown in this manual.
- 430HD screens are identical unless indicated otherwise.

The figure below shows the phone's screen in idle state.

Figure 3-1: Phone Screen in Idle State

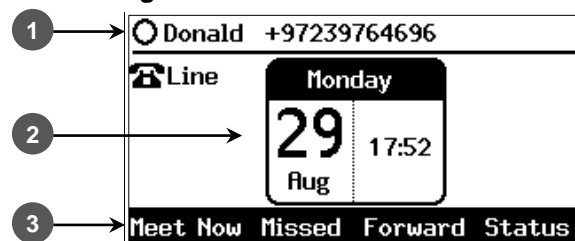

Reference:



Table 3-1: Phone Screen in Idle State

Reference	Description
1	Presence status: Available, Busy, Off Work, Appear Away, Be right back. See Section 6.21 for details.
	User name and phone number configured by your network administrator using the Web interface.
2	Day, Date and Month, automatically retrieved from the Network Time Protocol (NTP) server, enabled by your network administrator.
	Time, automatically retrieved from the Network Time Protocol (NTP) server, enabled by your network administrator.
3	Softkeys; to activate a softkey, press the hard key on the device, located below the screen, corresponding to the softkey. See Table 3-2 for softkey descriptions.

3.2 Softkeys

The table below describes the softkeys displayed in the screen. Press the hard key located on the device below the softkey in order to activate the softkey.

Table 3-2: Softkeys

Softkey	Description
Meet Now	Initiates a phone conference based on the Skype for Business server. Replaces the Conf softkey displayed in earlier versions of the 440HD phone and in the 430HD phone.
Missed	Displays missed calls.
Forward	Automatically forwards calls.
Status	Displayed in idle state. Lets you sets your presence status: Available, Busy, Off Work, Appear Away, Be right back.
Sign in /Sign out	Sign in is displayed if you haven't signed in yet, in the idle screen. Sign out is displayed if you press the Status softkey after signing in.
	Displayed after lifting the handset (for example). Opens the 'Favorites' defined in the Skype for Business client.
	Displayed after lifting the handset (for example). Displays the Call Log.
Select	Identical to the hard OK key on the phone. Either can be used. Selects a menu or option.
BToE	Displayed after pressing the MENU hard key. Generates a code for manually pairing the phone with Skype for Business client, for unified communications.
A/a/1	Enables switching between input modes: abc, ABC, Abc, 123, or T9.
Save	Saves settings.
Cancel	Cancels the currently initiated call or configuration.
Dial	Displayed after a number is keyed, a directory contact is selected, or a logged call is selected.
Clear	Displayed after entering a digit of a phone number (for example). Deletes from right to left.
	Displayed after a number is dialed and answered on the other side, and after you answer a call. Displays the Call Menu.
Conf	Displayed (1) after a number is dialed and the call is answered on the other side and (2) after you answer a call. Pressing it displays the ADD PARTICIPANT screen.
BXfer	Displayed (1) after a number is dialed and the call is answered on the other side and (2) after a call is answered. Lets you transfer the call in a blind transfer.
URL	Displayed after lifting the handset (for example). Enables calling a URL.
Detail	Displayed after selecting a call log (for example). If selected, the details of a logged call are displayed (Time, Date, etc.).
+Fav	Displayed in the Call Details screen. Allows adding the person to the Favorites directory.
End	Displayed after pressing the Dial softkey (for example). Ends the call.
Back	Displayed after pressing the MENU key (for example). Returns to the previous screen.
Start	Displayed after pressing Forward > Forward to a number (for example).
Edit	Displayed after you select a contact to be edited (for example).
Delete	Displayed after pressing the MENU key on the phone and then selecting Call Log (for example).
Silent	Displayed when the phone rings on an incoming call. Lets you silence the ring.
Reject	Displayed when the phone rings, alerting to an incoming call. Lets you reject the call.
Accept	Displayed when the phone rings, alerting to an incoming call. Lets you accept the call.

3.3 Navigating the Phone Menu

The MENU key on the phone lets you access information and configure settings shown in the figure below. Press it to view call logs, view meetings scheduled in the calendar for that day (integrated with Skype for Business client), configure speed dials, customize phone settings, determine device status, perform administration, access 'Favorites' and other phone directories, and perform log upload to Microsoft server.

Figure 3-2: Phone Menu

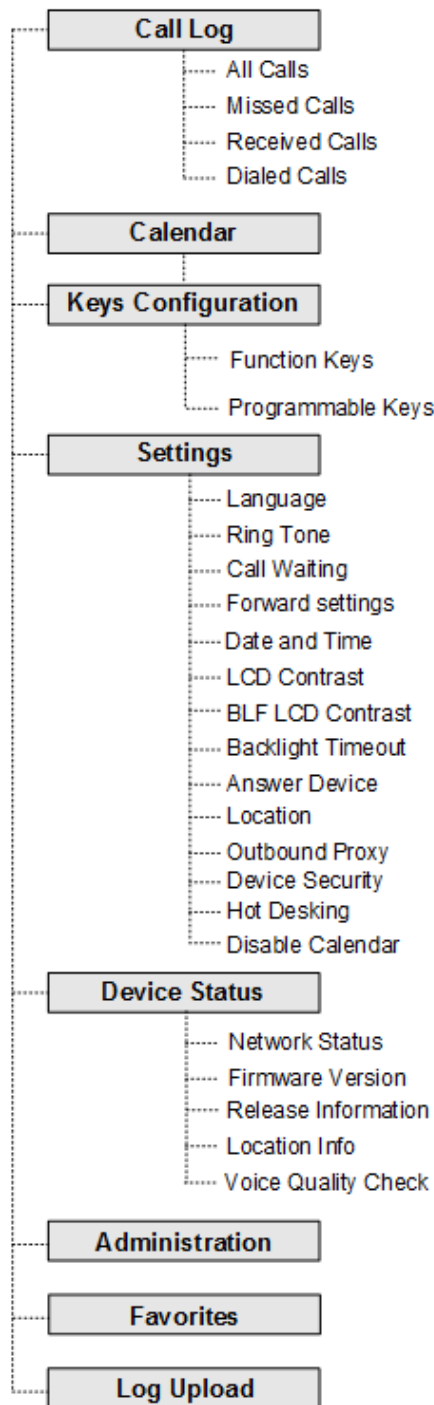

Note: The **Administration** item is intended for network administrators only. It is password protected. See the *Administrator's Manual* for details.

- **To access the menus:**
 - Press the MENU key located on the device.
- **To navigate to menu items:**
 - After opening the menu, press the navigation control button's lower rim -OR- press the menu item's number, e.g., press **3** to navigate to **Keys Configuration**.
- **To select a menu or menu item:**
 - Press the **Select** softkey or press the navigation control's **OK** button.
- **To cancel and move to a previous menu level:**
 - Press the **Back** softkey.

3.4 Selecting an Alphanumerical Mode

The phone's keypad allows you to input letters of the alphabet, numbers or symbols, and to switch from one mode to another.

- **To select a number, letter or symbol (e.g., lower case letters):**
 1. When configuring a contact, for example, press the **A/a/1** softkey:

Figure 3-3: Alphanumerical Selection

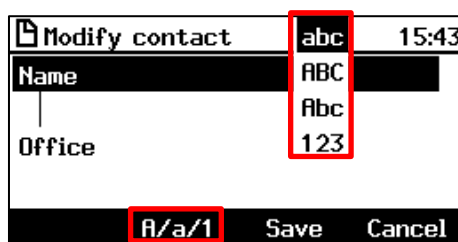

You can also access the mode menu by pressing the # key on the keypad. Press the # key successively to navigate in the mode menu.

2. From the mode menu, navigate to and select:
 - **abc** = lower case letters
 - **ABC** = upper-case letters
 - **Abc** = first-letter upper case, the rest lower case
 - **123** = numerical mode (i.e., numbers)
3. Select **abc** (for example) and then on the keypad, press the **ABC** key (for example); **a** is entered. Press the **JKL** key three successive times; **l** is entered; pressing it once produces **j**, twice produces **K**). Similarly, enter **a** and **n**.

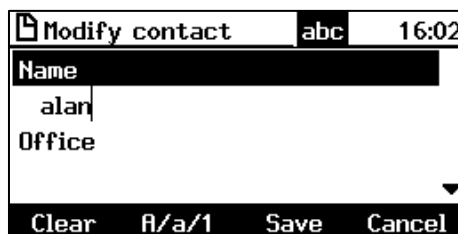

➤ **To enter a symbol (e.g., dot or @ or hyphen):**

1. Press the **A/a/1** softkey and navigate to **abc** (mandatory).
2. Press the **1** key on the keypad; a period / full stop is entered. *Immediately* press the **1** key again; a backslash is entered. Pressing successively produces the following symbols:

Symbol	Explanation	Symbol	Explanation
.	Dot	*	Star sign
\	Backslash	=	Equal sign
@	At		Separator
;	Semi-colon	(Open parenthesis
:	Colon)	Close parenthesis
#	Pound	{	Open parenthesis
\$	Dollar	}	Close parenthesis
%	Percentage	[Open square parenthesis
^	Caret]	Close square parenthesis
&	Ampersand	"	Double quotation marks
!	Exclamation mark	'	Single quotation mark
?	Question mark	>	Greater than
+	Plus	<	Less than
-	Hyphen	,	Comma
_	Underscore	/	Forward slash
~	Approximates		

Note that the asterisk (*) symbol is entered directly using the star key.

Figure 3-4: Entering a Symbol (e.g., a dot)

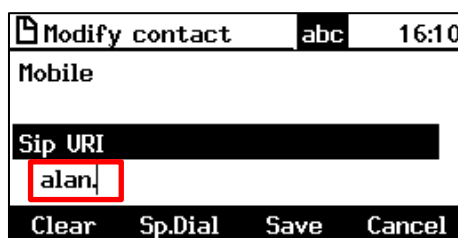

➤ **To revert to letters (e.g., abc):**

- Make sure the phone is in **abc** mode and successively press the **PQRS** key three times to produce **r** (for example):

Figure 3-5: Reverting to Letters (e.g., abc)

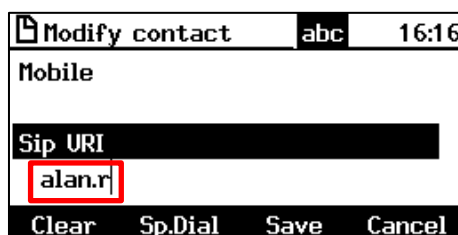

This page is intentionally left blank.

4 Signing In

This section shows how to sign in to the phone.

➤ To sign in to the phone:

1. In the idle screen, press the **Sign in** softkey on the device; the sign-in options are displayed:

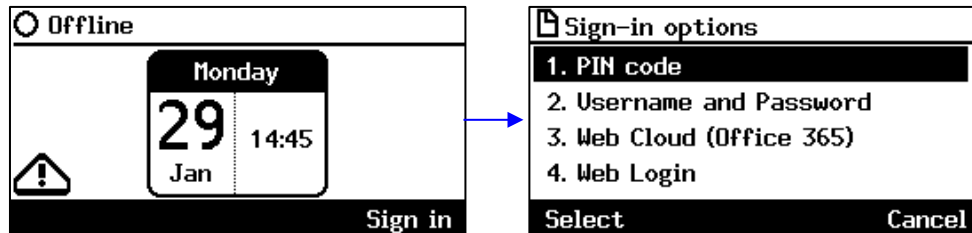

- PIN code - see Section 4.1
- User name and Password - see Section 4.2
- Web Cloud (Office 365) - see Section 4.3
- Web Login – see Section 4.4



Note:

- If a user signs out and another signs in, the phone presents empty Speed Dials and empty Call Logs to the newly signed-in user. The Speed Dials and Call Logs of the signed-out user are not saved on the phone.
- Sign-in can be cancelled during the signing in procedure. You can cancel signing in after starting the sign-in process.

4.1 Signing in with PIN Code

This section shows how to sign in with the PIN code and phone number. The PIN code is provided by your network administrator.

➤ To sign in with the PIN code:

1. In the 'Sign-in options' screen shown above, select **PIN Code**.

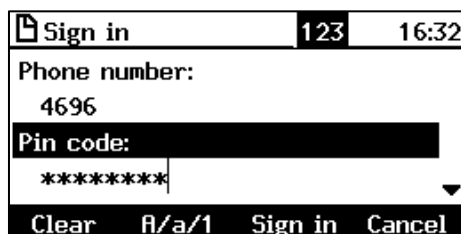

2. Enter your phone number and then navigate down to enter your PIN code. You can get it from your network administrator if necessary. To switch from numbers to alphabetical letters and symbols, see Section 3.4.
3. Press the **Sign in** softkey; the Lock Code screen opens (see Section 5 for more information).

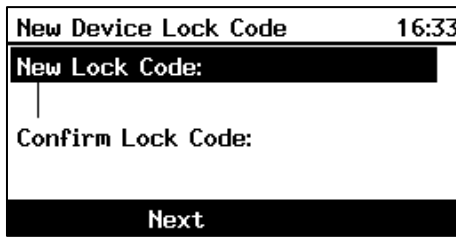

4. Enter a lock code and then press the **Next** softkey or navigate down. Enter the lock code again to confirm, and then press **OK**; the phone is signed in and the idle screen is displayed.

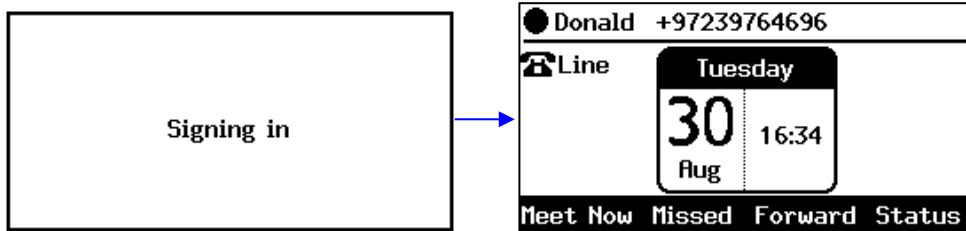

4.2 Signing in with User Name and Password

This section shows how to sign in with User Name and Password.

- **To sign in with User Name and Password:**

1. In the 'Sign-in options' screen, select **User name and Password**.

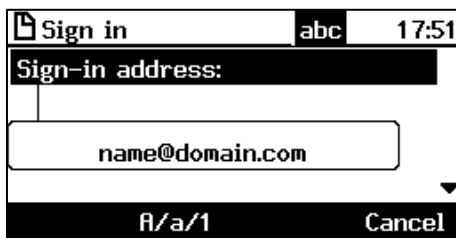

Note: Signing in with a username that is a NetBIOS Domain Name, i.e., **domain\username**, or with the PIN Code, are *disallowed* for Skype for Business online sign-in. They are only allowed for *on-premises* sign-in. Online sign-in must be in the following format:

- Sign-in address, i.e., SIP URI. To switch from letters of the alphabet to symbols such as @, - and period, see Section 3.4.
- User name, in UPN (User Principal Name) format, i.e., the way the user's name appears in their e-mail address listed in the Active Directory: **username@domain.com**
- User's network IT password (the same password you use to access your PC)

2. Press the **Sign in** softkey that's displayed; after signing in successfully, the New Device Lock Code screen opens (see under Section 5 for more information).



4.3 Signing in with the Web Cloud (Office 365) Option

You can sign in with the Cloud PBX Web option a.k.a. Device Pairing. Sign-in with this enables connectivity to Microsoft's Cloud PBX, Microsoft's cloud-hosted version of enterprise voice.



Note: Applies only to Microsoft Cloud PBX users.

The option exempts users from having to laboriously key in their user name and password using the phone keypad.

➤ **To sign in using the Web Cloud (Office 365) option:**

- When the phone is offline, press the **Sign-in** softkey and from the 'Sign-in options' screen select **Web Cloud (Office 365)**. A URL and a Pairing Code are then displayed:

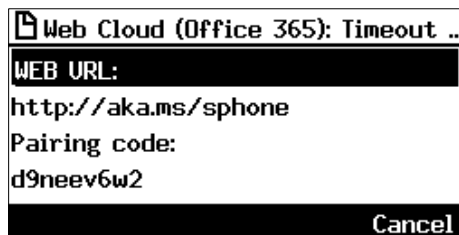

Users must then point their browser to the URL and enter the Pairing Code in the Microsoft web page. Sign-in to Microsoft's Cloud PBX is then performed.

4.4 Signing in using the Web Login Option

Users can sign-in to their phone from the browser on their PC. This sign-in option allows users to use the PC keyboard to quickly enter sign-in credentials rather than the longer method on the phone's keypad requiring switching input from letters of the alphabet to numbers and vice versa.



Note: Applies to Skype for Business online and on-premises. Username and password sign-in as well as BToE sign-in are supported.

➤ **To sign in using the Web Login option:**

1. When the phone is offline, press the **Sign-in** softkey and from the 'Sign-in options' screen select **Web Login**.

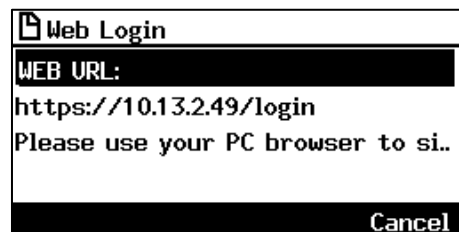

2. Enter the displayed Web URL in your browser's address field **<phone IP address>/login**

Web Login

Sign-in address

User name

Password

- In the Web Login page that opens, enter your username and password (ask the administrator if necessary) and then click **Sign in**.

4.5 Signing in as a Common Area Phone (CAP) User

A phone can be configured as a CAP. Configured *per physical phone* rather than *per user*, a CAP requires a special sign-in method called 'CAP provisioning'. Before signing in, your network administrator needs to enable the phone as a CAP.

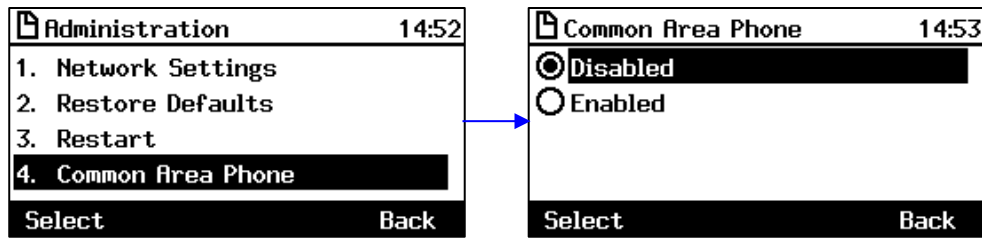

After the phone is enabled as a CAP, it restarts.

➤ **To sign in using the CAP Provisioning option:**

- When the phone is offline, press the **Sign-in** softkey and from the 'Sign-in options' screen select **CAP Provisioning**.

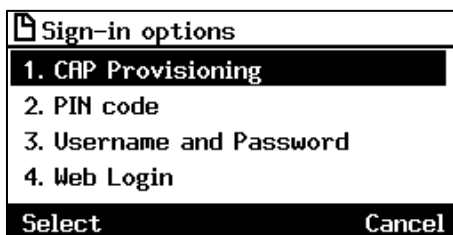

- After selecting the 'CAP provisioning' method, view a displayed URL and Pairing Code.

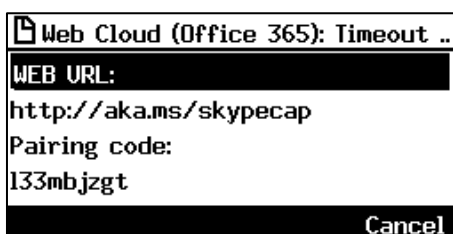

- Point your browser to the URL, sign in to Office 365 and locate the phone.

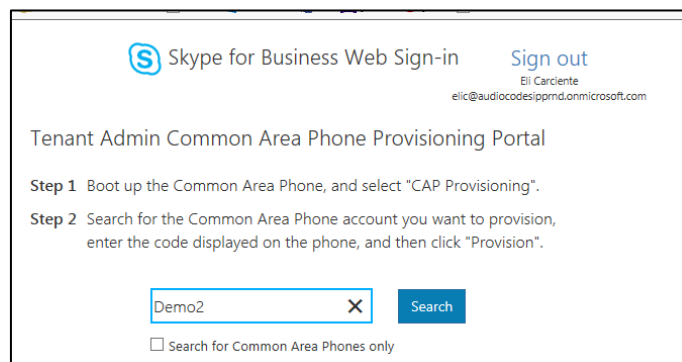
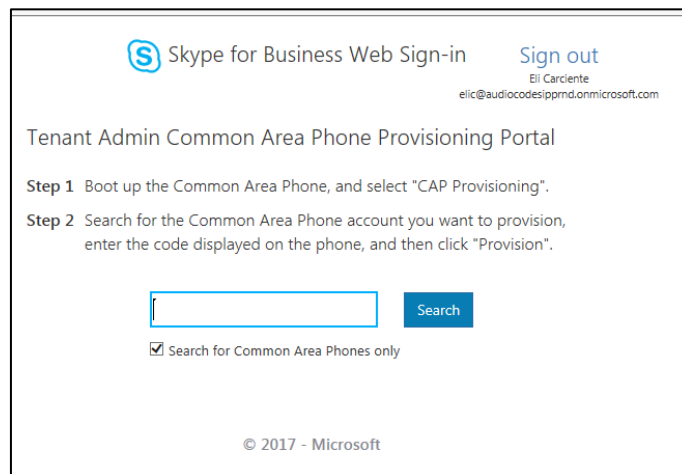
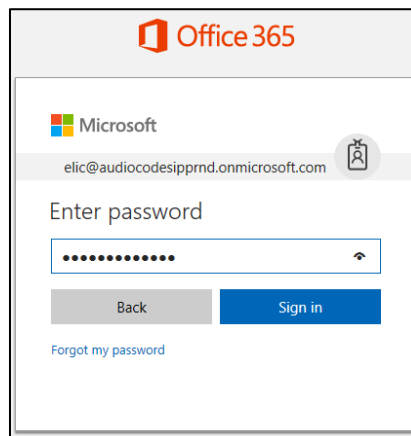
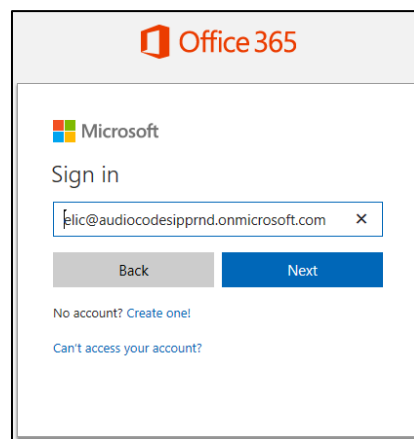
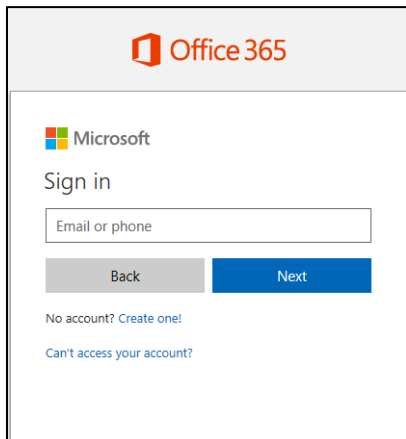

4. Enter the Pairing Code in the Microsoft web page and clicks **Provision**.

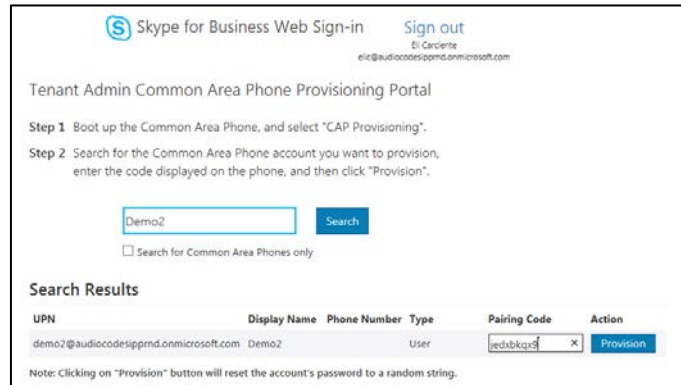

Sign-in to Microsoft's Cloud PBX is performed.

4.6 Signing Out

Signing out may be necessary when moving from one office to another or to prevent unauthorized use when out of office.

➤ **To sign out:**

1. In the idle screen, press the **Status** softkey.
2. In the Status screen press the **Sign out** softkey.

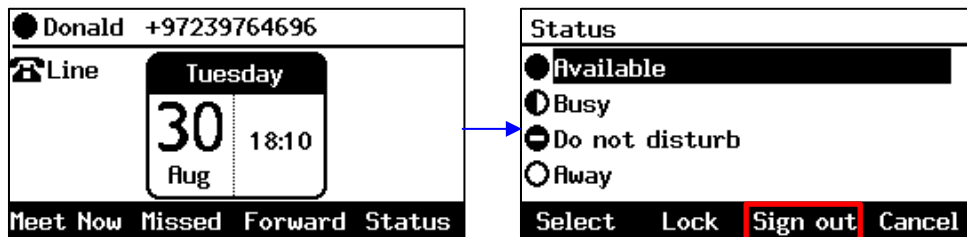

You're now signed out. You're returned to the idle screen displaying the **Sign in** softkey.

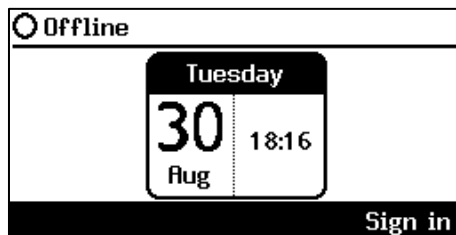

Note:

- After signing out, the next time you sign in the phone will present the option that was used to sign in before signing out.
- If a user signs out and another signs in, the phone presents empty Speed Dials and empty Call Logs to the newly signed-in user. The Speed Dials and Call Logs of the signed-out user are not saved on the phone.

4.6.1 Signing out if the 'Sign out' Softkey is Removed from the Screen

Located in lobbies, cafeterias, employee lounges, meeting rooms, and other gathering places, Common Area phones typically do not display a **Sign out** softkey in the screen, in line with network management's decision to remove the capability from users. Users can sign out, if necessary, using the Web interface.

➤ **To sign out using the Web interface:**

1. Obtain the Common Area phone's IP address (**MENU** key > **Status** > **Network Status** > **IP Address**) and point your Web browser to it; the phone's Web interface login page opens.

Figure 4-1: Login

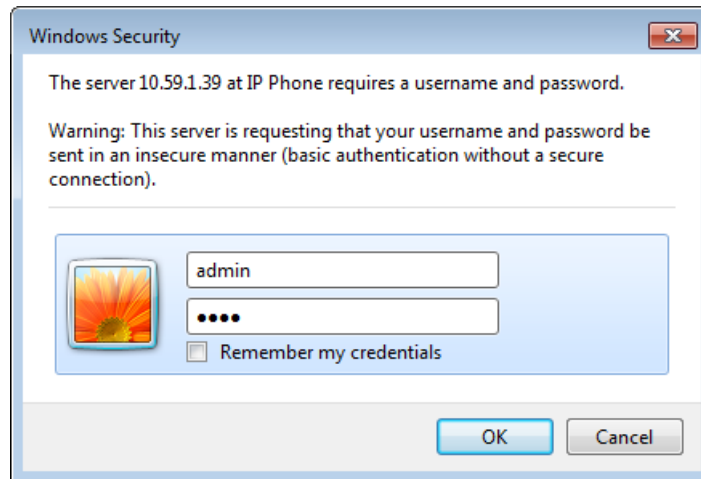

2. Enter the login credentials (default username is **admin** and default password is **1234**); the Home page of the Web interface is displayed.

Figure 4-2: Web Interface – Home Page

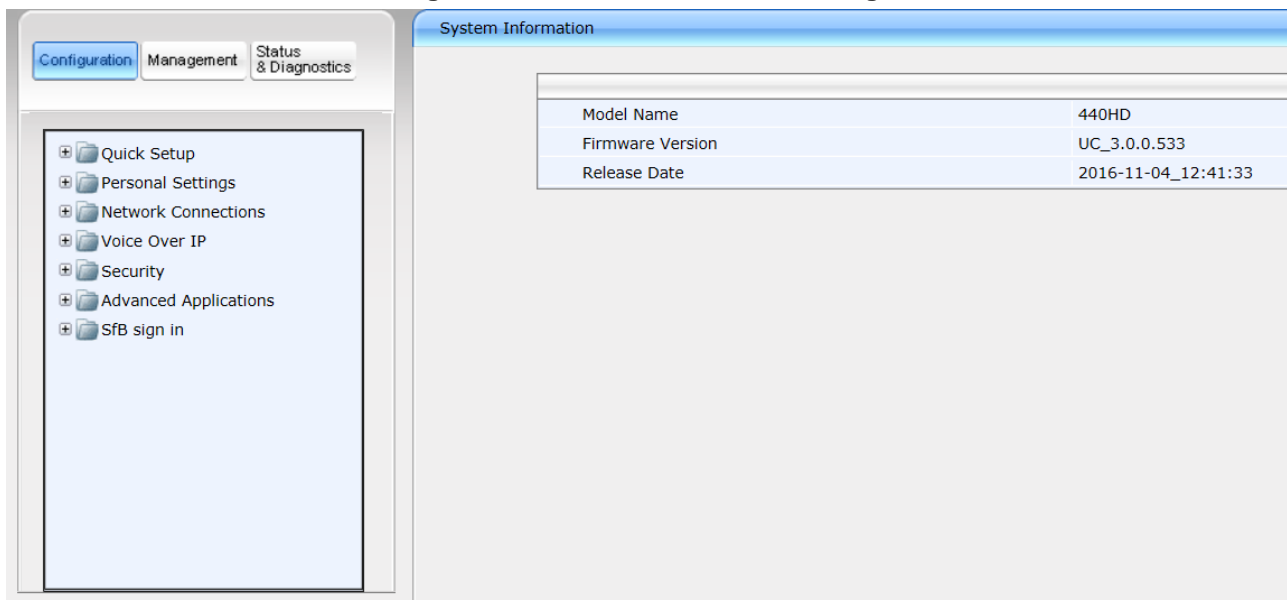

3. In the Web interface, open the Sign-In page (**Configuration** tab > **SfB sign in** > **Sign in**).

Figure 4-3: Sign-in – Content Blocked Page

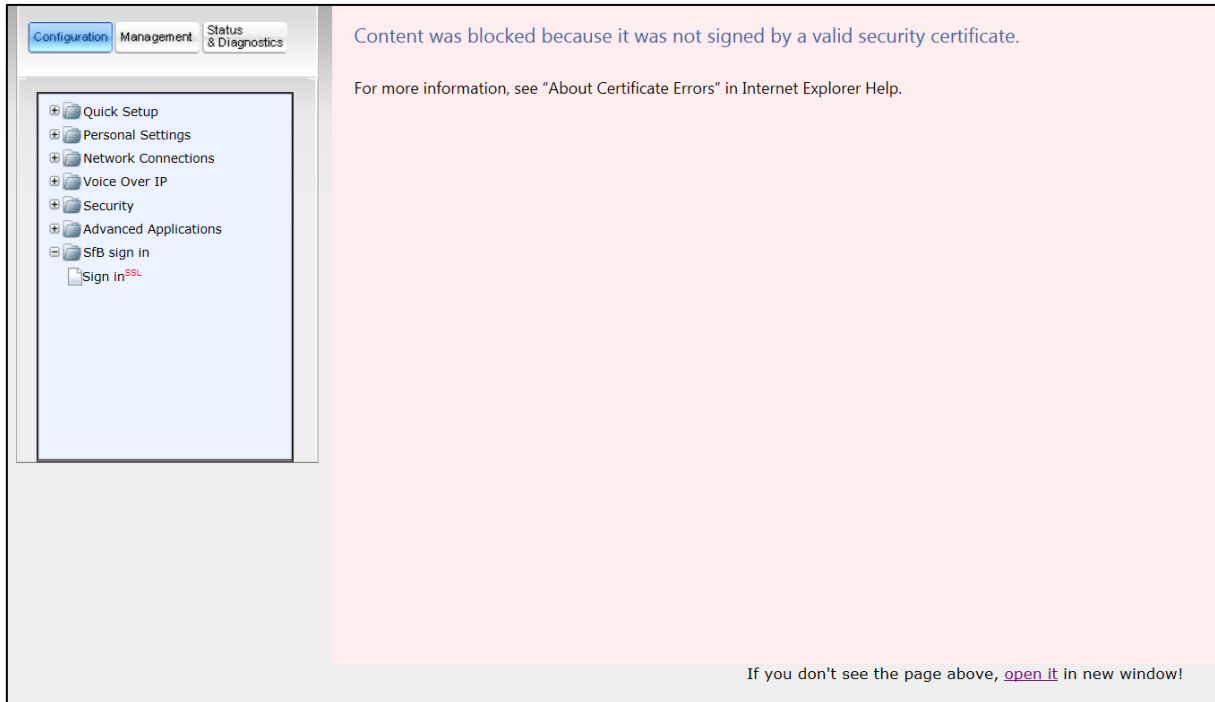

4. Click the **open it** link and then click **Show content**.

Figure 4-4: Sign-in – Windows Security Prompt

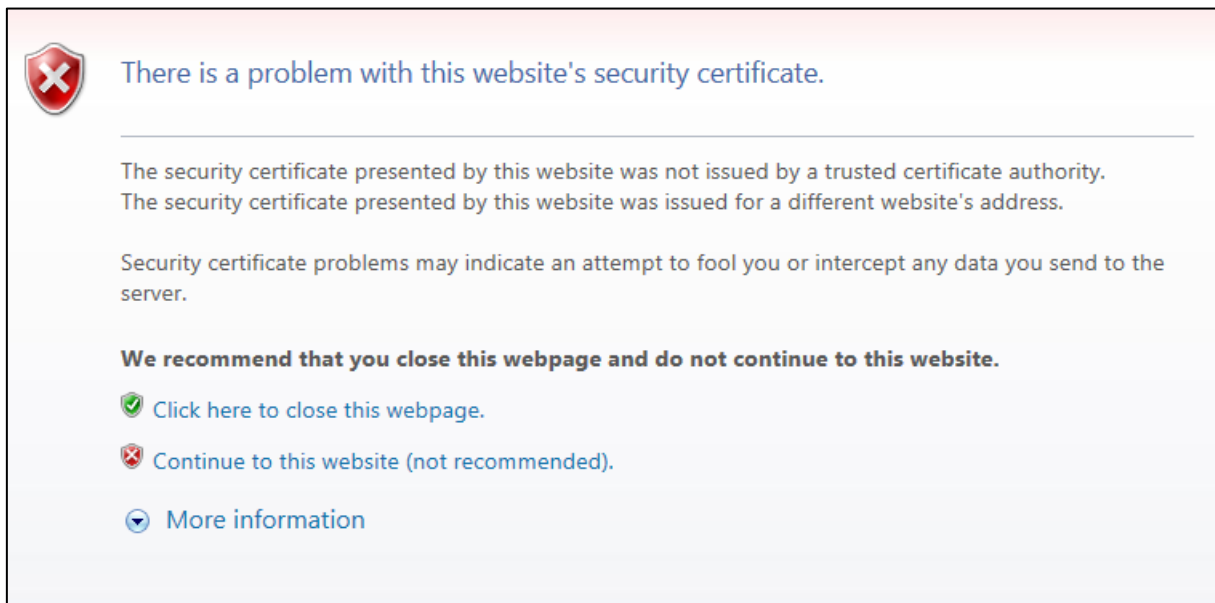

5. Click the **Continue to this website (not recommended)** link.

Figure 4-5: Windows Security Prompt

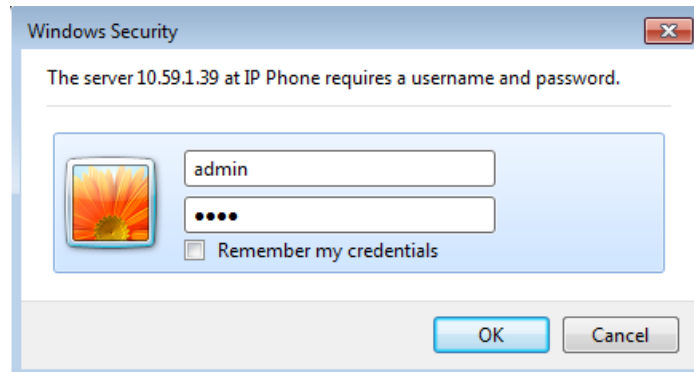

6. In the Windows Security prompt, enter the username and password and then click **OK**.

Figure 4-6: Sign-out

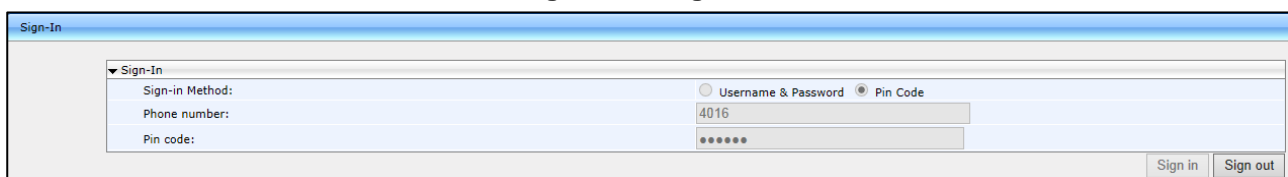

7. Click the **Sign out** button.

4.7 Hot Desking

Employees in enterprises that operate according to a 'touch-down desk' concept can use this feature. Employees in these enterprises typically travel frequently to remote branches, or work in shifts. They can sign in to a phone that is already signed in by another (CAP or regular) user without signing out the original user to whom the phone was assigned for primary use.

➤ To use the Hot Desking feature:

1. Press the MENU key on the phone.

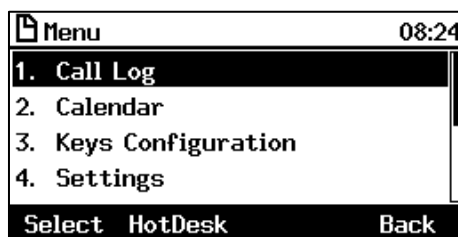

2. Click the **HotDesk** softkey; the 'HotDesk Sign-in options' screen opens – identical to the regular sign-in screen.
3. Select **PIN code** -or- **Username and Password** -or- **Web Sign-in** (see the subsections under Section 4 for more information).



Note:

- If the feature isn't enabled on the server already, the network administrator must enable it.
- When the HotDesk user signs out or if the phone stays in idle state longer than the HotDesk timeout defined on the server, the phone automatically returns to its original user and state; its configuration and data are preserved as they were before the phone was leased for HotDesk use. HotDesk users cannot perform all operations that the original (CAP or regular) user could perform, for example, change Language.

4.8 Displayed Messages

Messages indicating processes in progress, displayed in the screen, include:

Table 4-1: Displayed Messages Indicating Processes In Progress

Message	Description
Initializing	Initializing
Discovering LLDP	Discovering VLAN using Link Layer Discovery Protocol (LLDP)
Discovering CDP	Discovering VLAN using Cisco Discovery Protocol (CDP))
Acquiring IP	Acquiring an IP address from a DHCP server
Initializing Network	Initializing the network
Signing in	Signing in to the Skype for Business server
Signing in...Contacting time server	Get the time from the NTP server
Discovering SfB server	Auto discovering the Skype for Business server on the network
Registering	Registering to a Skype for Business server (after booting up the phone)
Downloading Firmware File	Downloading a firmware file
Upgrading Firmware	Upgrading the phone's firmware
Signing out	Signing out of the Skype for Business server

5 Unlocking a Locked Phone



Note: For the automatic locking feature to be available to users, the administrator must first enable it in the Skype for Business server and Web interface. See the *Administrator's Manual* for details.

The phone supports the capability to automatically lock after a configured period of time. The feature secures phones against unwanted (mis)use. If left untouched for 10 minutes (default), the phone automatically locks and is inaccessible to anyone who doesn't know its lock code. After a phone locks:

- Incoming calls are allowed, but outgoing calls need the lock code.
- Without the lock code, users cannot access the Call Log, Calendar and Corporate directory, but they can call preconfigured emergency numbers.

When signing in for the first time, the user is prompted for a lock code. After entering a code, e.g., **123456**, confirming it, and saving it, the phone goes into idle state, and after 10 minutes it is automatically locked.

➤ **To manually change the lock code:**

1. Press the MENU key on the phone, select **Settings** and then scroll down to select **Device Security**.

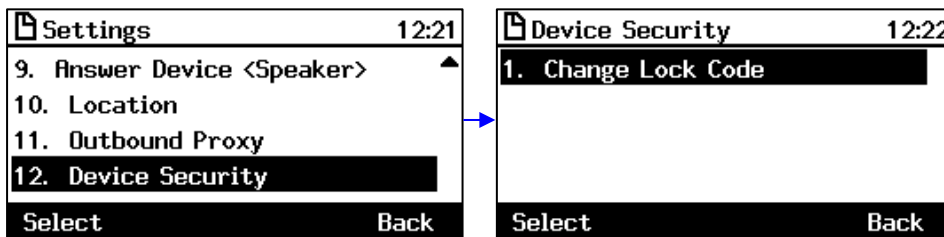

2. In the Device Security screen that opens, select **Change Lock Code**, enter the old code, click **OK**, then when prompted for the new code, enter it, press the **Next** softkey or scroll down, and then confirm by reentering the code.

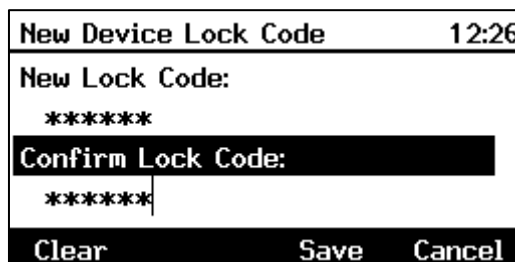
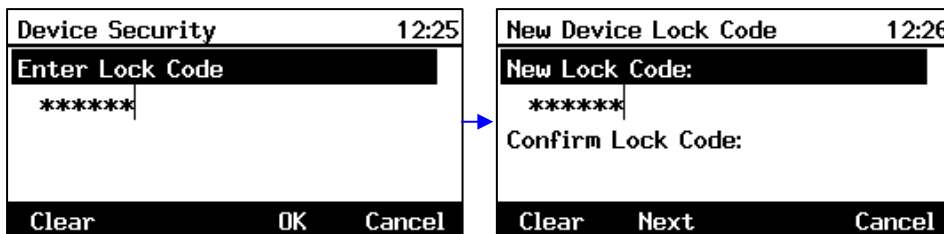

3. Press the **Save** softkey; if left untouched for 10 minutes (default), the phone will automatically lock.



Note: Emergency numbers (police, ambulance service, firefighting service, etc.) will still be available and dialable in the event the phone locks via a new **Emergency** softkey that is displayed after the lock takes effect.

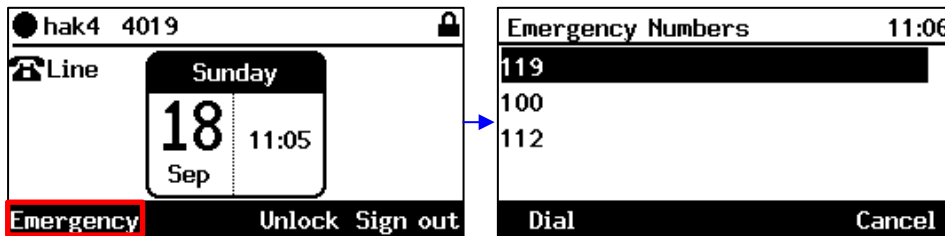

➤ **To manually lock a phone:**

You can manually lock a phone at any time you choose.

- When the phone is idle, press the **Status** softkey and then press the **Lock** softkey that is displayed; the phone locks and an **Unlock** softkey is displayed in the idle screen.

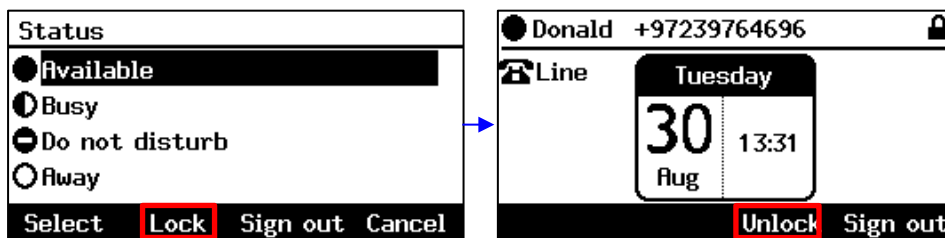

➤ **To unlock a phone that's been locked:**

You can unlock a phone that's been locked only if you know the lock code.

- In the idle screen, press the **Unlock** softkey, enter the lock code that was entered as described under Section 5, and then press the **OK** softkey.

5.1 Dialing Emergency Numbers if the Phone is Locked

If the phone locks, emergency numbers such as for the police, ambulance service, firefighting service, etc., will still be available and dialable via an **Emergency** softkey that is displayed in the phone's idle screen after the lock takes effect.

You can select an emergency number from a list of emergency destinations. A dedicated number for the police, ambulance service, fire fighting service, etc., can be selected from a list of options, for example:

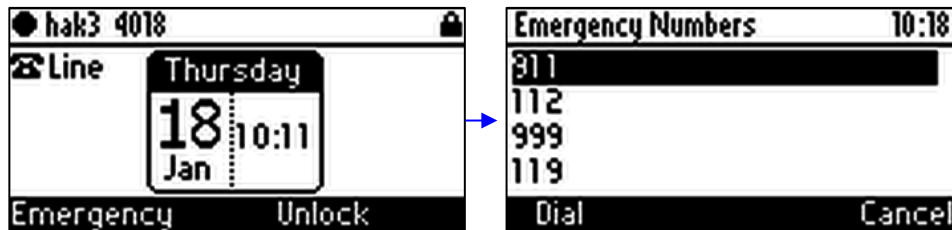

Note: The network administrator must define these emergency numbers in the Skype for Business server for the feature to be available.

5.2 Using Other Functionalities if the Phone is Locked

Your network administrator can allow other capabilities besides making emergency calls, even though your phone is locked, in compliance with Microsoft Skype for Business. Your network administrators can configure your phone to:

- Allow you to make outgoing calls even though the phone is locked
- Allow you to receive incoming calls even though the phone is locked
- Allow you to answer Delegate calls even though the phone is locked
- Allow you to use the phone's handset even though the phone is locked



Note: Consult your network administrator if necessary. For more information, see the *Administrator's Manual*.

This page is intentionally left blank.

6 Customizing Your Phone

You can customize your phone to boost usability and friendliness.

6.1 Changing the Screen Language

The phone screen supports multiple languages. English is the default but you can change it to another.

➤ **To change the default:**

1. Access the **Languages** screen (MENU key > **Settings** > **Language**).

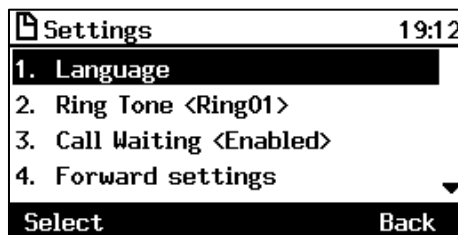

2. Navigate to the language you require.



3. Press the **Select** softkey to select it.
4. Press the **Save** softkey to save the setting.

6.2 Selecting Ring Tone

You can choose from a selection of ring tones to indicate incoming calls .

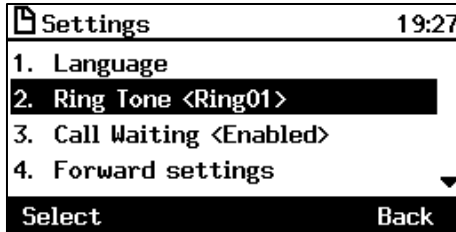

➤ **To select a ring tone:**

1. Access the **Ring Tone** screen (MENU key > **Settings** > **Ring Tone**).

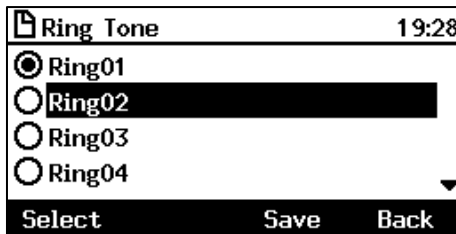

2. Navigate to and select a ring tone. A sample of each ring tone is played as you navigate through the list.



3. Set ring tone volume by pressing the VOL  or VOL  key:

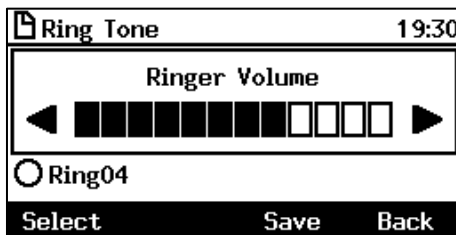

A few seconds after adjusting the volume level the Ringer Volume indication is hidden.

4. Press the **Select** softkey to apply your settings.
5. Press the **Save** softkey to save your settings.

6.3 Enabling Call Waiting

You can enable or disable the call waiting feature.

➤ **To enable or disable call waiting:**

1. Access the **Call Waiting** screen (MENU key > **Settings** > **Call Waiting**).

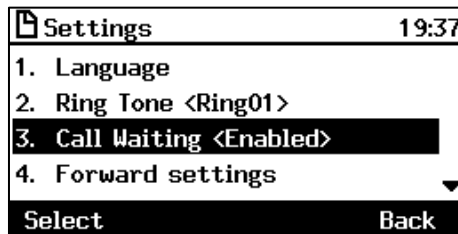

2. Navigate to and select:
 - **Disable** (disables call waiting)
-OR-
 - **Enable** (enables call waiting)
-OR-
 - **Busy on Busy** (see Section 6.4.1 below)

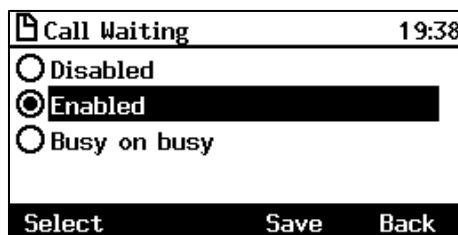

3. Press the **Select** softkey to apply your settings.
4. Press the **Save** softkey to save your settings.

6.4 Managing Simultaneous Incoming Calls

If two calls simultaneously come in on a phone, or if a user is in a call and a third party calls, the phone's screen displays them in a graphically user-friendly way.

- Simultaneous incoming calls; both calling parties flash:



- When one of the incoming calls is answered:

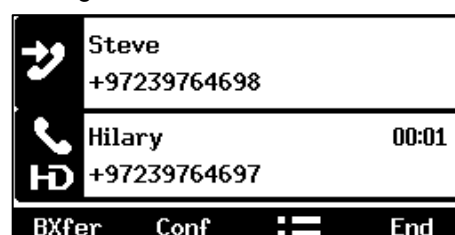

- When a phone is in a call and another comes in:



Additional visual indications on the device:

- The LED of the Programmable Key that is configured as an extension flashes red when a call comes in on that extension
- The LED of the Programmable Key that is configured as an extension is illuminated green after a call that comes in on that extension is answered
- The Ring LED in the upper right corner of the device flashes blue when a call comes in

6.4.1 Configuring Busy on Busy

If you're already in an active call on either the IP phone or Skype for Business client and a call comes in, the Busy on Busy feature rejects the coming call and plays a busy signal to the caller.

➤ **To configure Busy on Busy:**

1. Access the **Call Waiting** screen (MENU key > **Settings** > **Call Waiting**).

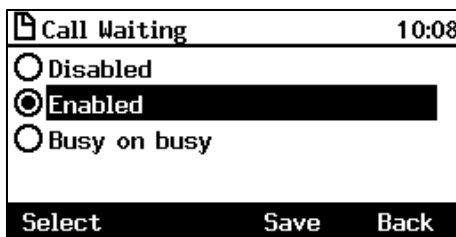

2. Select the **Busy on Busy** option.

6.5 Defining Call Forwarding

This feature enables you to automatically redirect an incoming call to another phone number if a user-defined condition is met, e.g., if the line is busy.

➤ To define call forwarding:

1. Access the **Automatic Forward** screen (MENU key > **Settings** > **Forward settings** -or- press the **Forward** softkey when the screen is in idle state):

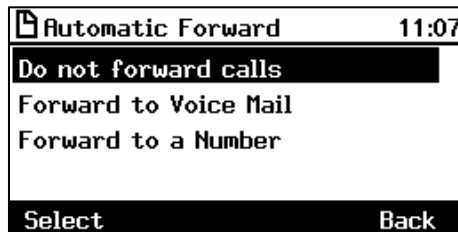

2. To forward to voicemail: In the Automatic Forward screen, navigate to **Forward to Voice Mail** and press the **Select** softkey; you're returned to the idle screen; calls will be automatically forwarded to your voicemail.
3. To forward to a number: In the Automatic Forward screen, navigate to **Forward to a Number** and press the **Select** softkey:

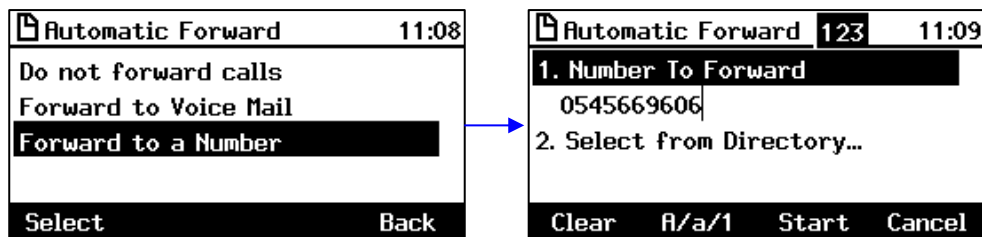

4. Enter the number and press the **Start** softkey; you're returned to the idle screen; calls will be automatically forwarded to the number.

➤ To deactivate call forwarding:

When the screen is in idle state press the **Forward** softkey and in the Automatic Forward screen, select **Do not forward calls**.

6.6 Setting Date and Time

Date and time is automatically retrieved from the deployed Network Time Protocol (NTP) server, enabled by your administrator.

➤ **To enable the NTP server:**

1. Access the **Date and Time** screen (MENU key > **Settings** > **Date and Time**).

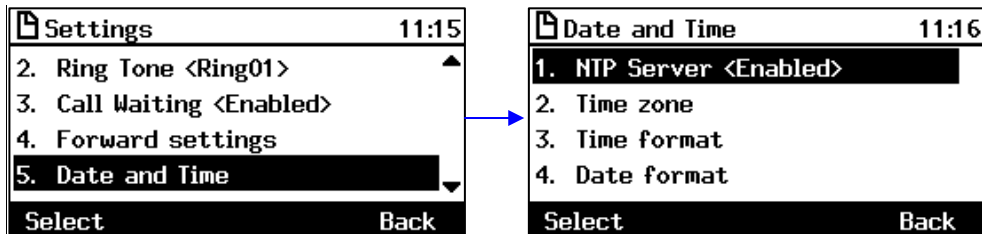

2. If *not* already 'Enabled', notify your network administrator.



Note: To configure the NTP server, see the *Administrator's Manual*.

➤ **To configure the time zone:**

1. Navigate to and select the **Time zone** option and then select the time zone relevant to your geographical location. See [Table 6-1](#) for a list of all Time Zone options.



➤ **To configure the time format:**

- Navigate to and select the **Time format** option and then select the format of your choice.

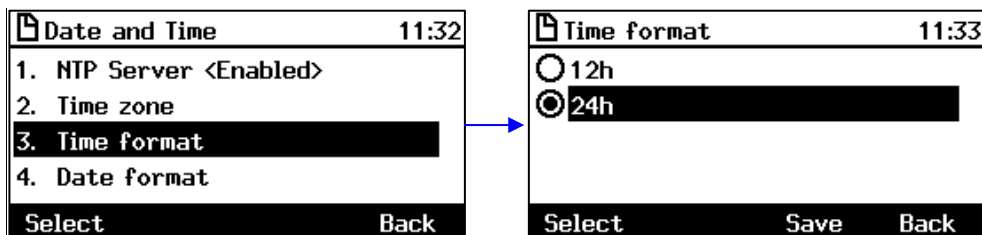

➤ **To configure the date format:**

- Navigate to and select the **Date Format** option and select the format of your choice.

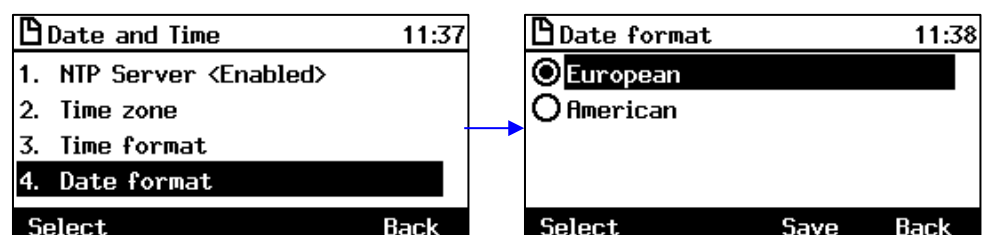

Table 6-1: Time Zones

Time Zone	Place
(GMT-12:00)	Eniwetok, Kwajalein
(GMT-11:00)	Midway Is, Samoa
(GMT-10:00)	Hawaii, Alaska
(GMT-08:00)	Pacific Time (US & Canada)
(GMT-07:00)	Chihuahua, Mazatlan, Mountain Time (US & Canada)
(GMT-06:00)	Central Time (US & Canada)
(GMT-05:00)	Eastern Time (US & Canada)
(GMT-04:00)	Atlantic Time (Canada)
(GMT-03:30)	Newfoundland, Buenos Aires, Georgetown, Brasilia, Greenland
(GMT-03:00)	Buenos Aires, Georgetown, Brasilia, Greenland
(GMT-02:00)	Mid-Atlantic
(GMT-01:00)	Azores, Cape Verde Is
(GMT 00:00)	Greenwich Mean Time: Dublin, Edinburgh, Lisbon, London, Casablanca, Monrovia
(GMT+01:00)	Amsterdam, West Central Africa, Madrid, Paris, Vilnius, Berlin, Bern, Rome, Vienna, Prague
(GMT+02:00)	Cairo, Jerusalem, Bucharest, Helsinki, Riga, Tallinn, Athens, Istanbul, Minsk, Harare, Pretoria
(GMT+03:00)	Kuwait, Riyadh, Nairobi, Baghdad, Moscow, St. Petersburg, Volgograd
(GMT+03:30)	Tehran
(GMT+04:00)	Abu Dhabi, Muscat, Baku, Tbilisi, Kabul
(GMT+05:00)	Islamabad, Karachi, Tashkent, Yekaterinburg
(GMT+05:30)	Bombay, Calcutta, Madras, New Delhi
(GMT+05:45)	Kathmandu
(GMT+06:00)	Almaty, Dhaka, Colombo, Almaty, Novosibirsk
(GMT+06:30)	Rangoon
(GMT+07:00)	Bangkok, Hanoi, Jakarta, Krasnoyarsk
(GMT+08:00)	Beijing, Chongqing, Hong Kong, Urumqi, Perth, Singapore, Taipei, Irkutsk, Ulaan Bataar
(GMT+09:00)	Osaka, Sapporo, Tokyo, Seoul, Yakutsk
(GMT+09:30)	Darwin, Adelaide
(GMT+10:00)	Canberra, Melbourne, Sydney, Brisbane, Guam, Port Moresby, Hobart, Vladivostok
(GMT+11:00)	Magadan, Solomon Is, New Caledonia
(GMT+12:00)	Fiji, Kamchatka, Marshall Is, Auckland, Wellington
(GMT+13:00)	Nuku'alofa

6.7 Changing Screen Contrast Level

The phone's screen supports 36 different contrast levels. The range is 0-35. The default is 14. You can choose the level that suits you best.

➤ **To define the screen's contrast level:**

1. Access the **LCD Contrast** submenu (MENU key > **Settings** > **LCD Contrast**).

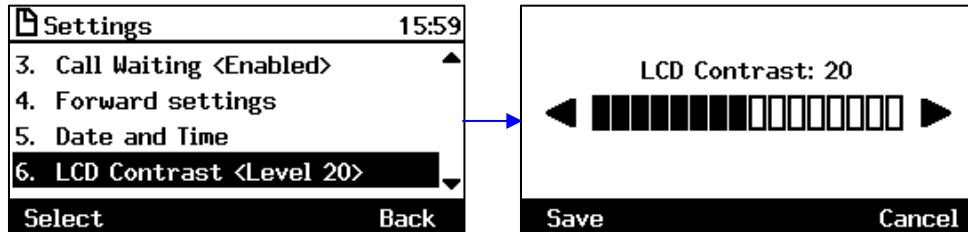

2. Press the navigation control's left or right rim to navigate to the contrast level that suits you best.
3. Press the **Save** softkey to apply your settings.

6.8 Defining BLF LCD Contrast



Note: Applies only to the 440HD IP Phone.

The BLF LCD supports 40 different contrast levels. The range is 0-39. The default is 16. You can choose the level that suits you best.

➤ **To define the BLF LCD's contrast level:**

1. Access the **BLF LCD Contrast** submenu (MENU key > **Settings** > **BLF LCD Contr.**).

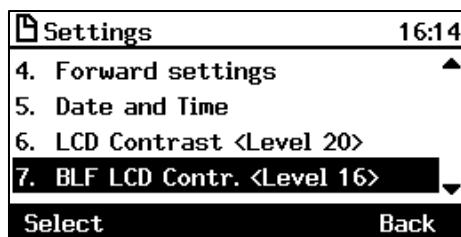

2. Press the navigation control's left or right rim to navigate to the contrast level that suits you best.

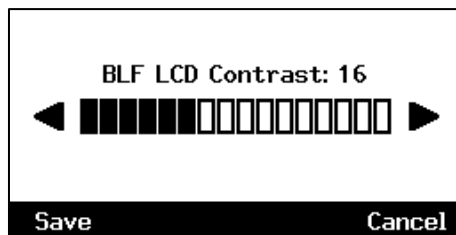

3. Press the **Save** softkey to apply your settings.

6.9 Defining Screen's Backlight Timeout

You can define how long the phone's backlight will stay on when the phone is idle. When this duration times out, the backlight switches off. For the backlight to never time out, you can select the **Always on** option. The default is 10 seconds.

➤ **To define screen backlight timeout:**

1. Access the **Backlight Timeout** screen (MENU key > **Settings** > **Backlight Timeout**).

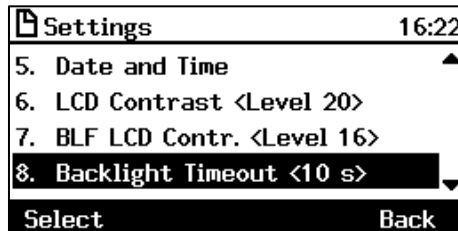

2. Navigate to and select **Always on** or **10 / 20 / 30 / 40 / 50 / 60 seconds**).

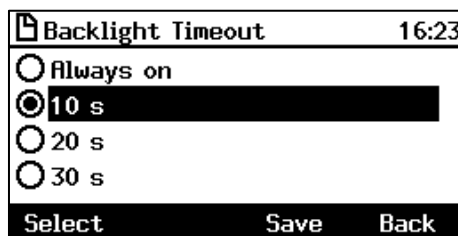

3. Press the **Select** softkey to apply your settings.
4. Press the **Save** softkey to save your settings.

6.10 Selecting an Answering Device

You can select which audio device (speaker or headset) is activated when you answer calls (by pressing the **Accept** softkey or lifting the handset) or when you dial calls (by pressing the number keys on the keypad and then pressing the **Dial** softkey).

The default device is the speaker.

➤ **To select the answering device:**

1. Access the **Answer Device** screen (MENU key > **Settings** > **Answer Device**).

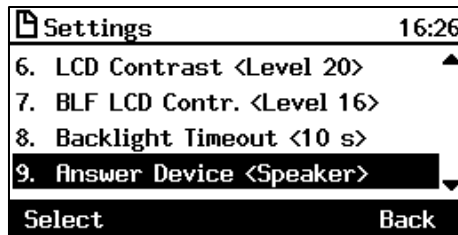

2. Navigate to and select the device (Speaker or Headset) and press the **Select** softkey.

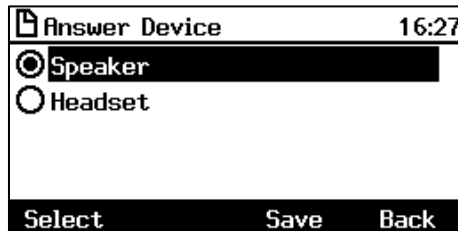

3. Press the **Save** softkey.

6.11 Defining Location

This feature enables the called party to identify the geographical location of the calling party. For example, if a caller in the U.S. makes an emergency call to E911, the feature extracts the caller's information for the police department to immediately identify the caller's location.

The network administrator configures geographical location for each subnet (see the *Administrator's Manual*). After you sign in, your geographical location is downloaded via inband provisioning. If geographical location is not provisioned by the server, a popup opens in the phone's screen enabling users to either **Set** the location manually, **Skip** (the popup closes but pops up every few hours), or **Dismiss** ('kills' the popup).

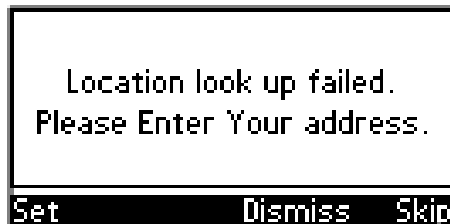

➤ **To manually set location:**

- Access the **Location** screen (MENU key > **Settings** > **Location**).

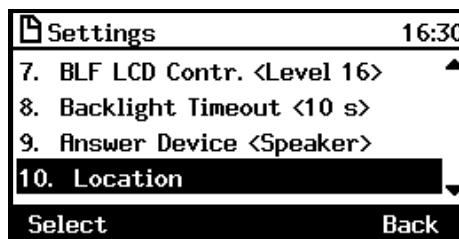

6.12 Defining an Outbound Proxy

Skype for Business Server Multitenant Hosting Pack is a Microsoft® Unified Communications (UC) hosting solution for telecommunications and hosting providers. The solution enables Microsoft hosting partners to deploy a single instance of the Skype for Business Server software to securely and economically host multiple tenants with a rich, fully integrated UC solution.

To connect AudioCodes' Skype for Business-compatible phone to a hosted Lync environment (LHP), a dedicated 'Outbound Proxy' parameter is available which is used to configure the hosted service provider's domain name (FQDN).



Note: In hosted environments, it's common practice that this hosted domain name is different to the enterprise's domain name. Refer also to *400HD Series IP Phones for Skype for Business Hosting Partner (LHPv2) Environment Configuration Note*.

To configure a phone for an LHP environment, configure the address of the Outbound Proxy as the hosted service provider's domain name (FQDN).

➤ **To configure the address of the Outbound Proxy:**

1. Open the **Outbound Proxy** screen (MENU key > **Settings** > **Outbound Proxy**).

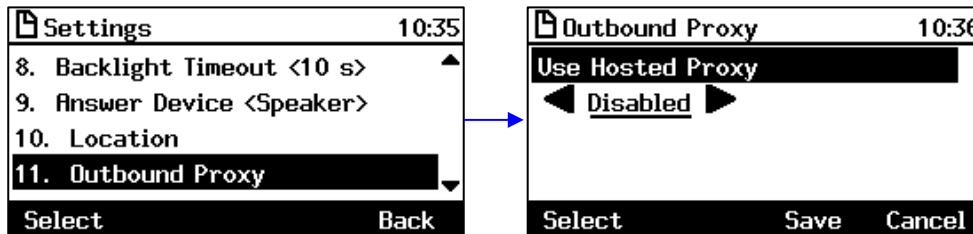

2. Press the right rim of the navigation control to set the 'Use Hosted Proxy' field to **Enabled**.

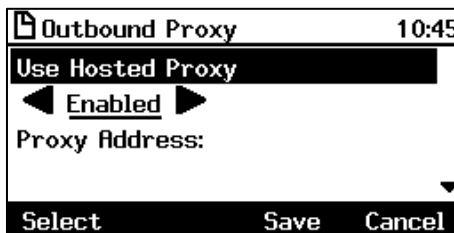

3. In the 'Proxy Address' field enter the hosted service provider's domain name (FQDN).

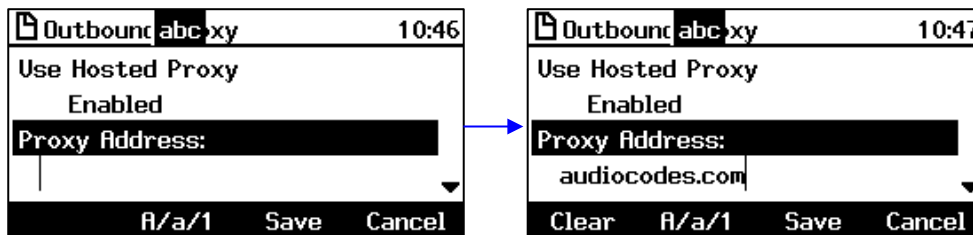

4. Navigate down to the 'Port' field, configure it (default = 0), and then press the **Save** softkey.

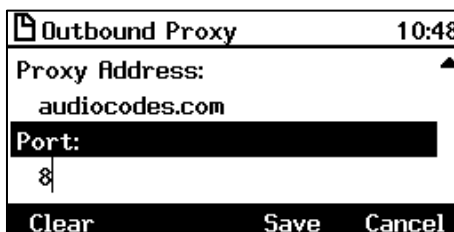

6.13 Adjusting Volume



You can adjust the volume of the phone's:

- Ring
- Tones (e.g., dial tone)
- Handset
- Speakerphone
- Headset



6.13.1 Adjusting Ring Volume

You can adjust the volume of the ring indicating an incoming call.

➤ **To adjust ring volume:**

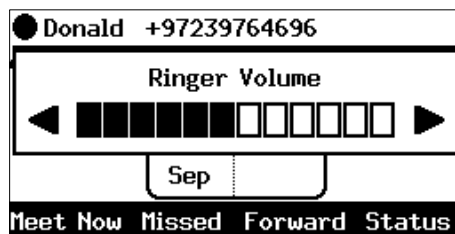
1. When the phone is in idle state (i.e., not in use), press the VOL  or VOL  key; the Ringer Volume bar is displayed on the screen:





2. Press the VOL  or VOL  key on the keypad to adjust the volume. After adjusting, the Ringer Volume level disappears from the screen.



6.13.2 Adjusting Tones Volume

You can adjust the phone tones, including dial tone, ring-back tone and all other call progress tones.

➤ **To adjust tones volume:**

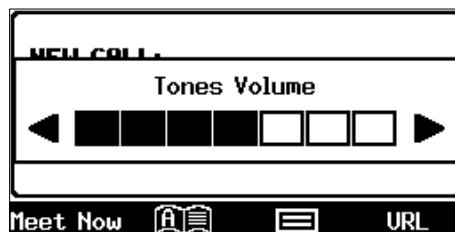
1. Off-hook the phone (using handset, speaker or headset).
2. Press the VOL  or VOL  keyboard key; the Tones Volume bar displays on the screen:



3. Press the VOL  or VOL  key to adjust the volume. After adjusting, the Tones Volume bar disappears from the screen.

6.13.3 Adjusting Handset Volume



The volume of the handset can be adjusted during a call or when making a call. The newly adjusted level applies to all subsequent handset use.

➤ **To adjust handset volume:**

1. During a call or when making a call ensure that the handset is off the cradle.

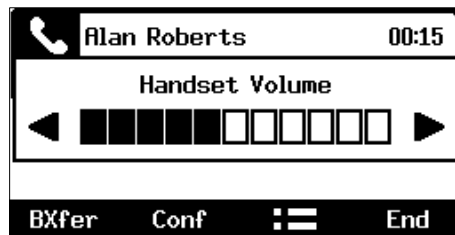
2. Press the VOL  or VOL  key; the Handset Volume bar is displayed on the screen.





3. Press the VOL  or VOL  key on the keyboard. After adjusting, the Handset Volume bar disappears from the screen.

6.13.4 Adjusting Speaker Volume

The volume of the speakerphone can only be adjusted during a call.

➤ **To adjust the speakerphone volume:**

1. During a call, press the SPEAKER key.
2. Press the VOL  or VOL  key; the Speaker Volume bar is displayed on the screen.

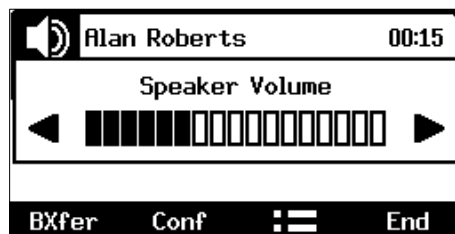



3. Adjust the volume using the VOL  or VOL  key. After you have completed adjusting the volume, the Speaker Volume bar disappears from the screen.



6.13.5 Adjusting Headset Volume

The volume of the headset can only be adjusted during a call.

➤ **To adjust the headset volume:**

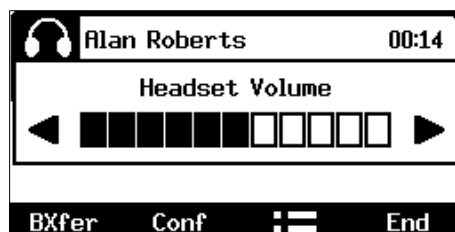
1. During a call, press the HEADSET key.
2. Press the VOL  or VOL  key; the Headset Volume bar is displayed on the screen.



3. Adjust the volume using the VOL  or VOL  key.

6.14 Managing Phone Directories

The phone supports a number of directories:

- Favorites (integrated with Skype for Business client)
- Corporate directory
- Personal directory
- Outlook Contacts
- Others



Note:

- You can add, edit and delete contacts in the Personal directory. You *cannot* in the Corporate directory. Your network administrator sets it up in the Microsoft Skype for Business server (see the *Administrator's Manual*).
- You can add a maximum of 1,000 contacts to your Personal directory. After adding a contact, you can call the contact directly from the directory. If you receive an incoming call from a contact listed in the directory, the screen displays the name listed.
- You can add, edit or delete contacts in the Skype for Business client's Favorites. See the *Skype for Business client documentation*.
- The Personal directory and Corporate directory display the presence status of contacts if your network administrator set them up in the Microsoft Skype for Business server (see the *Administrator's Manual*).
- If you assign a speed dial key to the contact, you can press it to call them.

6.14.1 Accessing Directories

All the directories are accessed from the CONTACTS hard key on the phone.

➤ **To access the Skype for Business client Favorites directory:**

- Press the **CONTACTS** key.



➤ **To access other directories:**

- In the Favorites screen shown above, press the **☰** softkey and select the directory of your choice.

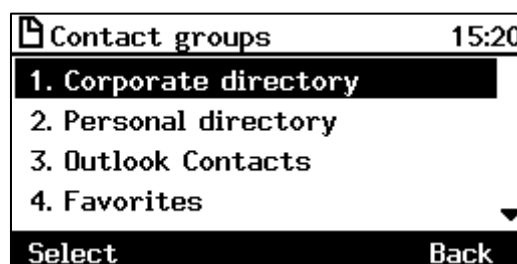

6.14.2 Adding a Contact to the Personal Directory

Contacts can be added to the Personal directory. You can enter their home number, office number, mobile number, and/or SIP URI. You can also define a Speed Dial to place calls quickly to the contact (see Section 6.16). After adding a contact you search and find them in the group, dial them, edit their contact information or delete them.



Note: You can add a maximum of 1,000 contacts to your Personal directory. After adding a contact, you can call the contact directly from the directory. If you receive an incoming call from a contact listed in the directory, the screen displays the name listed.

➤ **To add a contact to the Personal directory:**

1. Access the Personal directory.
2. Select **+ New contact** (press the **Select** softkey):

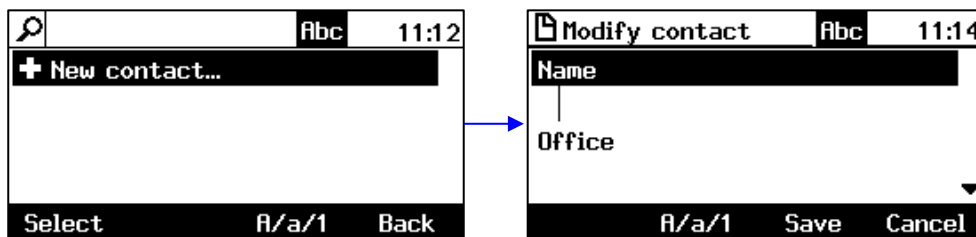

3. In the 'Modify contact' screen, key in the 'Name' of the new contact (see Section 3.4 for detailed instructions).
4. Navigate down and key in the new contact's office phone number (see Section 3.4 for detailed instructions).
5. Optionally, navigate down and key in the new contact's home and mobile numbers as well.
6. Optionally, navigate down and enter the contact's SIP URI, e.g., mike.dubb@audiocodes.com. You may find this option useful if you don't know their phone number.
7. Press the **Sp. Dial** softkey to assign a speed dial key if required:

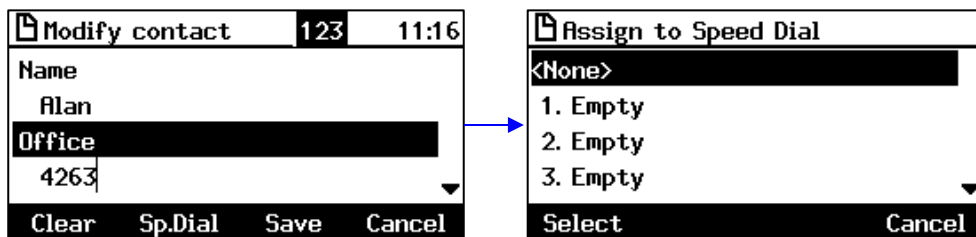

8. Navigate to the first Empty speed dial and press the **Select** softkey, a speed dial key is assigned to the contact.
9. Press the **Save** softkey; 'Contact Saved' is displayed.
10. To view the assigned speed dial, navigate down to the contact's name and press 'Detail'.

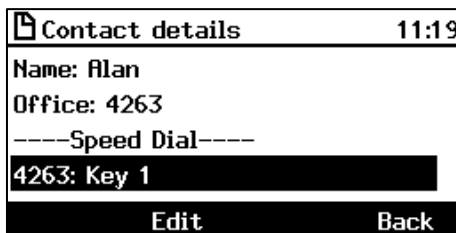

6.14.3 Editing Contact Information in the Personal Directory

Contact information in the Personal directory can be edited if for example a contact's details change because they move premises.

➤ **To edit contact information:**

1. Access the Personal directory and navigate to the name of the contact to edit:

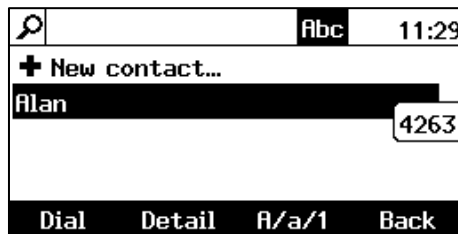

2. Press the **Detail** softkey:

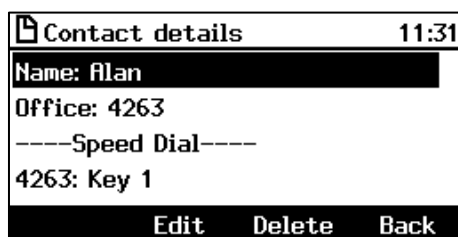

3. Press the **Edit** softkey:

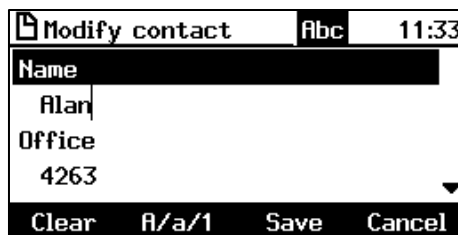

4. Modify the contact's details and press the **Save** softkey.



Note: The Corporate directory cannot be modified.

6.14.4 Deleting a Contact from the Personal Directory

A contact can be deleted from the Personal directory if for example they leave the organization.

➤ **To delete a contact from the Personal directory:**

1. Access the Personal directory and navigate to the contact to delete:

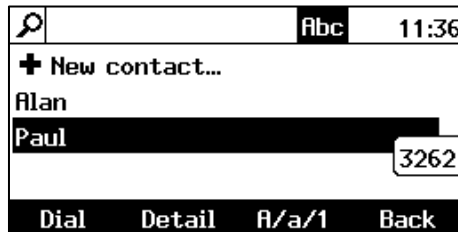

2. Press the **Detail** softkey; the contact details are shown.

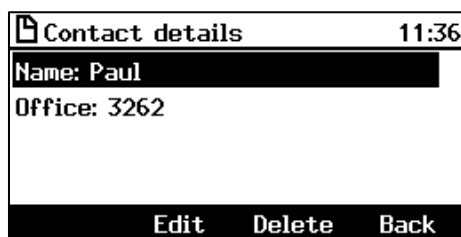

3. Press the **Delete** softkey; a 'Delete current contact?' warning message appears:

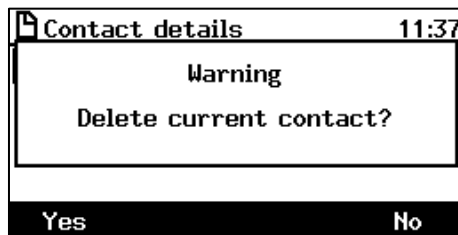

4. Press the **Yes** softkey to remove the contact from the phone directory or **No** if you want to keep the contact in the directory; the contact is removed from the directory.



Note: Corporate directory contacts cannot be deleted.

6.14.5 Adding a Person to Favorites after a Call with them is Logged

This section shows how to add a person to the Favorites directory after a call with them is logged.



Note: A maximum of 1,000 people can be added to the Favorites directory.

➤ **To add a person to your Favorites directory:**

1. Open the Call Log (MENU key > **Call Log**).

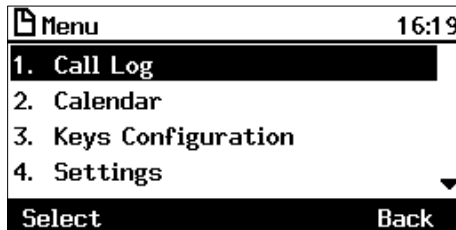

2. Select the call log:

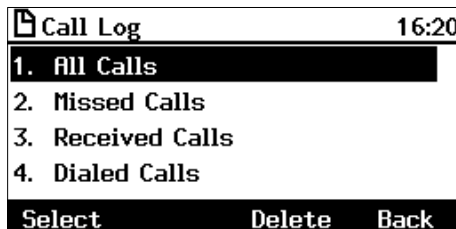

3. In the log, select the person with whom the call was made and then press the **Detail** softkey.

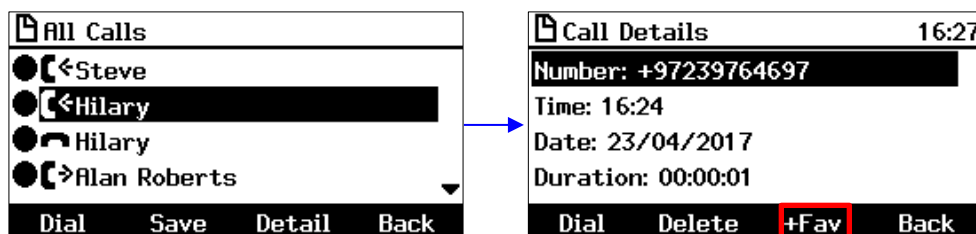

4. In the 'Call Details' screen, press the **+Fav** softkey; the person is added to your Favorites directory.

Successfully added
to Favorite



Note: You can also add a person to the Favorites directory from the Corporate Directory, Outlook Contacts, Personal Directory and (User) Groups, through the 'Contact details' screen's **+Fav** softkey, shown below.

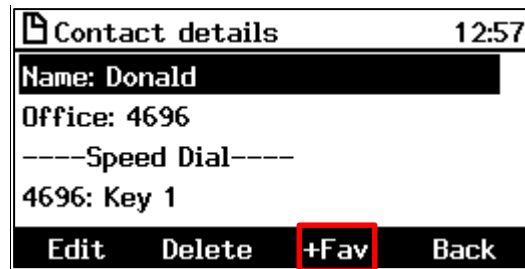

6.14.6 Removing a Person from Favorites

You can remove a person from the Favorites directory.

➤ **To remove a person from your Favorites directory:**

1. Open the Favorites directory (MENU key > **Favorites**).
2. Navigate to the person to remove and press the **OK** navigation control; the Contact Details screen opens.
3. Press the **-Fav** softkey; the person is removed from the Favorites directory.

6.14.7 Searching for a Contact in a Directory

The search feature enables you to quickly and easily locate a contact in a directory. The feature is especially useful if you have a long list of contacts.



Note: When searching in the Corporate directory, the T9 feature is available. See the next section for details.

➤ **To search for a contact:**

1. Access the phone directory.
2. Search for a contact:
 - Scroll down to the contact in the list
-OR-
 - Key the first letter in the contact's name; the directory locates contacts whose names begin with that letter. For example, as you press the **J** key to search for contact **Jonathan**, the directory locates contacts whose names begin with **J**. As you key in the next letter, i.e., **o**, contacts whose names begin with **Jo** appear, etc.

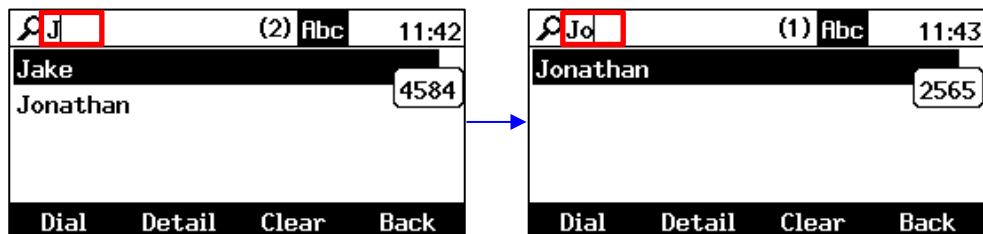

6.15 Searching for a Contact in the Corporate Directory using T9



Note: The T9 feature only applies to searching for a contact in the Corporate directory.

The T9 (Text on 9 keys) feature lets you press the **2** key, for example, on the dialpad to input the letter **C**. You only need to press it once. So to input **Charles** you can press **2427537**. T9 supports predictive search, so as letters are entered, possibilities are displayed before you finish entering the name. If the name **Alex**, for example, appears multiple times in the directory, users can enter **ALEX**, space (*), and then the first letter of the family name.

➤ **To access a contact in the Corporate directory using T9:**

1. Open the Corporate directory (press the CONTACTS hard key and in the Favorites screen that opens, press the **☰** softkey and select **Corporate directory**).



2. Note that **T9** is enabled by default. On the dialpad, press the key containing the first letter in the contact's name, for example, **A**. You only need to press it once. Then press the key containing the second letter, for example, **L**. You only need to press it once. Press the key containing the third letter, for example, **E**. You only need to press it once. If necessary, Press the fourth letter, for example, **X**.



3. Use the * key on the dial pad to enter a space, and then enter the first letter of the family name, if necessary.

6.15.1 Changing from T9 to A/a/1

You can search for a contact in the Corporate directory using T9 (default) or A/a/1.

➤ **To change from the default to A/a/1:**

1. Open the Corporate directory (press the CONTACTS hard key and in the Favorites screen that opens, press the **☰** softkey and select **Corporate directory**).
2. In the directory, press the **A/a/1** softkey and choose your preference:

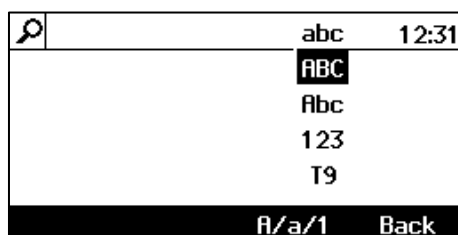

6.16 Defining Function Keys as Speed Dials

This section shows how to set up placing a call to a contact by pressing a Function Key defined as a Speed Dial. You can define each of the 12 Function Keys on the phone's BLF sidecar as a Speed Dial. Speed Dials for 12 contacts can therefore be defined. An additional five can be defined using the Programmable Keys – see Section 6.20).



Note: These are your own private Speed Dials. They are preserved even if you sign out of the phone, sign in with another user, sign out as that user, and then sign in again as your own user. The Speed Dials are preserved irrespective of whether configured on the BLF sidecar or on the Programmable Keys adjacent to the screen.

➤ **To define a Function Key as a Speed Dial:**

1. Access the **Function Keys** screen (MENU key > **Keys Configuration** > **Function Keys**):

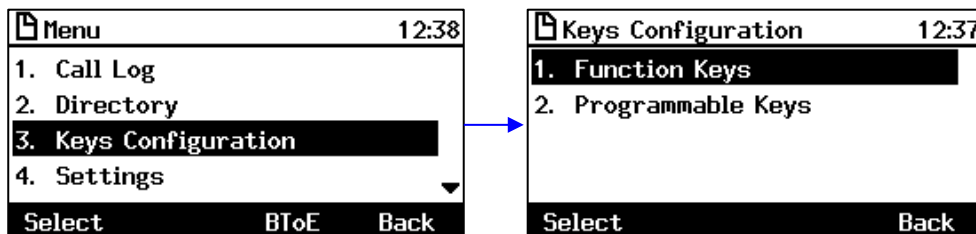

2. Navigate to and select an empty (undefined) Function Key; the selected Function Key is displayed (#2, in this example):

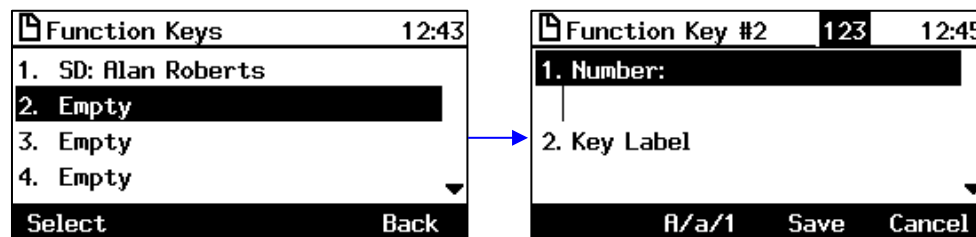

Note:

- **Function Key #1** is the topmost of the 12. **Function Key #2** is second from the top. **Function Key #12** is the lowermost.
- You can also access a **Function Key #** screen by long-pressing one of the twelve Function Keys.

3. In the 'Number' field, enter the contact's phone number, as shown below.
 - Navigate down to the 'Key Label' field and enter the contact's name to be displayed.

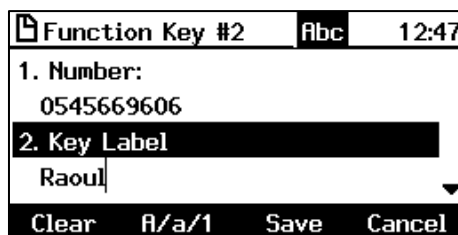

-OR-

- Skip the 'Number' and 'Key Label' fields and navigate down to and select **Select from Directory > Personal Directory** -or- **Corporate Directory** > the contact to whom to assign the Speed Dial:

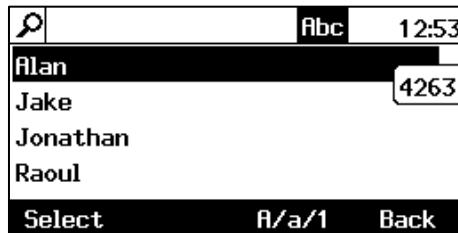
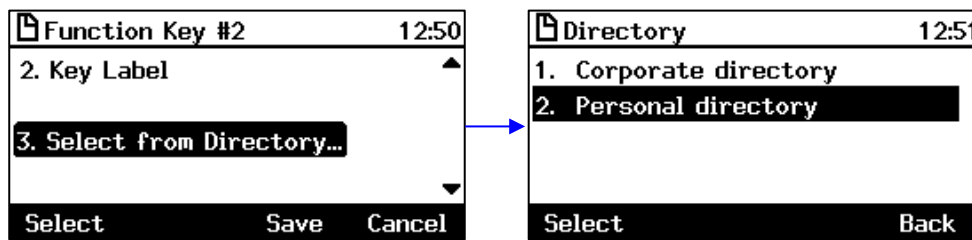

- Navigate down to 'Call Type' field:

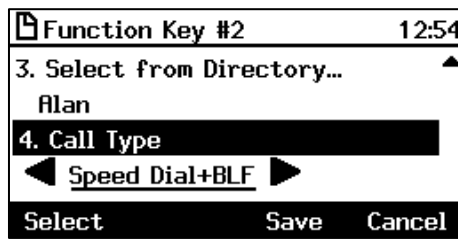

- Navigate to and select **Speed Dial** or **Speed Dial+BLF** (if you're unsure whether or not the contact is a Skype for Business contact, it's advisable to leave this parameter's default value unchanged).
4. Press the **Save** softkey; the SD is created; it is displayed in the BLF LCD (440HD phone only) and listed in the Function Keys screen (both phone models). The BLF will turn on if it's a Skype for Business contact.

6.16.1 Configuring Pause Dialing for a Speed Dial to an Ext. behind an IVR

Your network administrator can configure pause dialing for a Speed Dial, in order to create a time break. This is typically required for a Speed Dial which dials a destination extension number that is behind an Interactive Voice Response (IVR) system.



Note: Consult your network administrator if you need a pause dialing configured for a Speed Dial. See the *Administrator's Manual* for more information.

6.16.2 Editing a Speed Dial

You can edit a Speed Dial.

➤ **To edit a Speed Dial:**

1. Long-press the Function Key defined as a Speed Dial; the Function Key# screen is displayed.
2. In the 'Number' field, edit by pressing the **Clear** softkey to delete digits.
3. Navigate down to the 'Key Label' field. Edit by pressing the **Clear** softkey to delete letters.
4. Navigate down and select **Select from Directory** and then **Personal directory**. Navigate to and select a contact.
5. Navigate down to the 'Call Type' field and press the navigation control's left or right rim to navigate to and select either **Speed Dial** or **Speed Dial+BLF**.
6. Press the **Save** softkey to save the edit.

6.16.3 Deleting the Speed Dial

You can delete the Speed Dial.

➤ **To delete a Speed Dial:**

1. Access the Function Key # screen (MENU key > **Keys Configuration** > **Function Keys**).
2. Navigate to and select the Speed Dial to delete (**#1** in the example below).

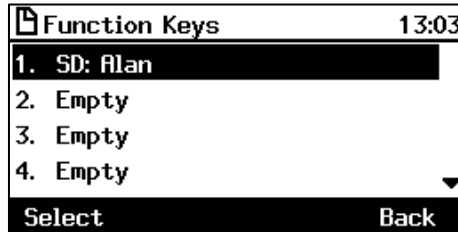

3. In the 'Number' field, delete the entire number using the **Clear** softkey.

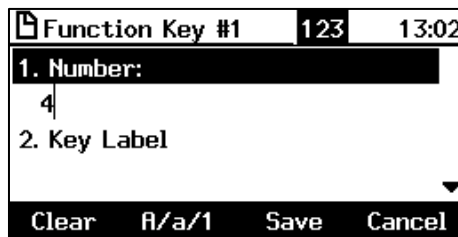

4. Press the **Save** softkey; the Speed Dial is now listed as 'Empty' in the Function Keys screen:

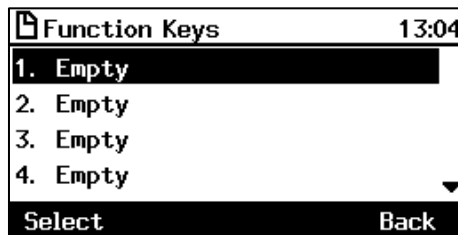

6.17 Defining Function Keys as Paging Dials

This section shows how to define a Function Key as a paging dial to page a group.



Note: Make sure the group paging feature is enabled – consult your network administrator.

You can define each of the 12 Function Keys on the phone's BLF sidecar to page up to 12 different paging groups. The paging feature allows a live announcement to be made (paged) from a phone to a group of phones, to notify a team (for example) that a meeting is about to commence at a certain venue. The paged announcement is multicast via a designated group IP address, in real time, on all idle phones in the group, without requiring listeners to pick up their receivers. The name of the group is displayed on phone BLF sidecar when the paging call comes in.

➤ **To define a Function Key as a paging dial:**

1. Access the **Function Keys** screen (MENU key > **Keys Configuration** > **Function Keys**):

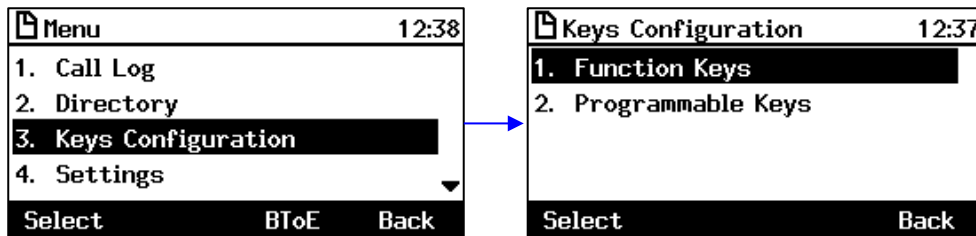

2. Navigate to and select an empty (undefined) Function Key; the selected Function Key is displayed:

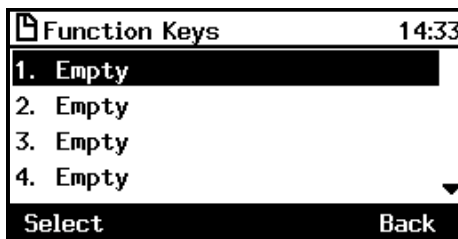

Note:



- **Function Key #1** is the topmost of the 12. **Function Key #2** is second from the top. **Function Key #12** is the lowermost.
- You can also access a **Function Key #** screen by long-pressing one of the twelve Function Keys on the phone's BLF sidecar.

3. Navigate to **Paging** (press the right rim of the navigation control button):

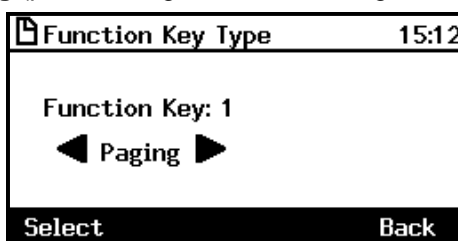

4. Press the **Select** softkey:

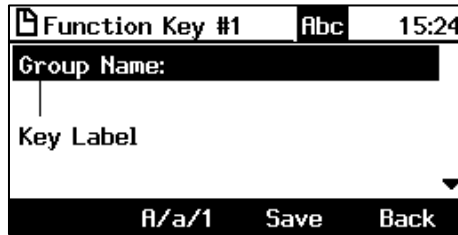

The screenshot shows a phone's configuration screen for 'Function Key #1'. The top status bar displays 'Function Key #1', 'abc', and '15:24'. The main area contains two text input fields: 'Group Name:' and 'Key Label'. The 'Group Name:' field has a cursor. At the bottom, there are three softkeys: 'A/a/1', 'Save', and 'Back'.

5. In the 'Group Name' field, enter the name of the group, to be displayed in the phone's screen when there's an incoming / outgoing paging call.
6. In the 'Key Label' field (applies only to the 440HD phone), define a name for the Feature Key-Paging Dial, to be displayed in the phone's BLF sidecar.
7. In the 'Multicast Address' field, enter the paging group's multicast IP address. Default: 224.0.1.0. For phones to be in a group, all must be configured with the identical multicast address.
8. In the 'Multicast Port' field, enter the group's port. Default: 8888. For phones to be in a group, all must be configured with the identical port.
9. Press the **Save** softkey; the Function Key is now configured for paging.

6.18 Defining Programmable Keys as Speed Dials

Three Programmable Keys are located on either side of the screen, making six in total.



Note: The upper left key is the preprogrammed line. It cannot be defined as a Speed Dial.

You can define the other five keys as Speed Dials just as you defined the 12 Function Keys as SDs as shown in Section 6.16. You can therefore define a total of 17 SDs on a phone.

➤ **To define a Programmable Key as a Speed Dial:**

1. Long-press a Programmable Key (that hasn't been defined) or press MENU > **Keys Configuration** > **Programmable Keys** and select an 'Empty'; this screen is displayed:

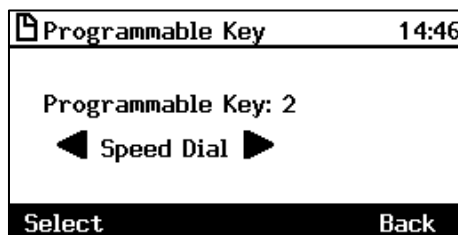

2. Press the navigation control's left/right rim to navigate to and select **Speed Dial** or **Speed Dial+BLF**:

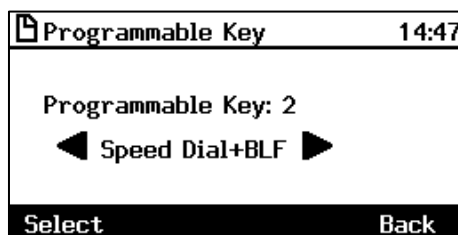

3. Press the **Select** softkey; this screen opens:

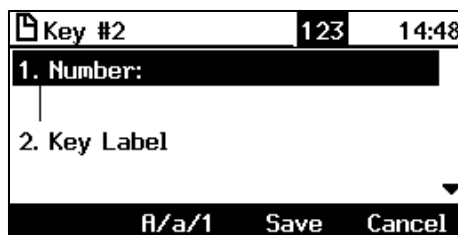

4. Define the 'Number' and 'Key Label' field – or navigate down to select the **Select from Directory** option - as you did when defining a Function Key as Speed Dial (see Section 6.16) and press the **Save** softkey; the screen reverts to idle mode displaying the Speed Key icon next to the name of the contact you defined ('Raoul', in this example):



5. To quickly place a call, press the key on the phone opposite 'Raoul'; the number is dialed.

6.18.1 Deleting the Speed Dial

➤ To delete a Speed Dial:

1. Long-press the key opposite the Speed Dial displayed in the screen ('Raoul', in the previous example); this screen is displayed:

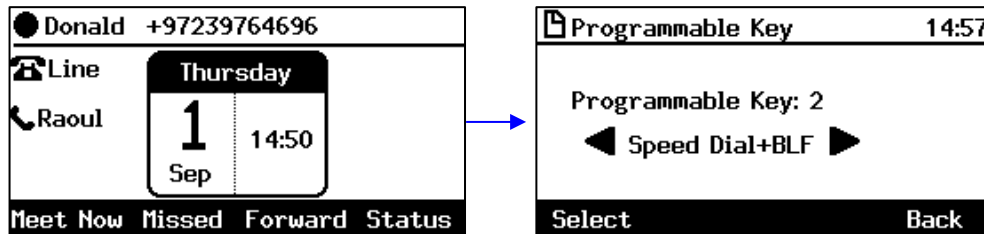

2. Press the navigation control's left or right rim to navigate to and select **Empty**:

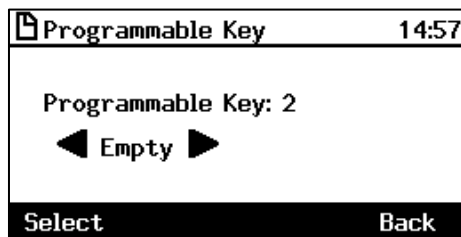

3. You're returned to the idle screen; the Speed Dial is removed:

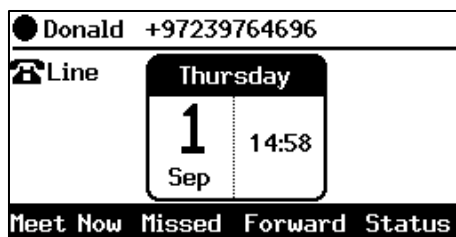

6.19 Defining Programmable Keys as Paging Dials

This section shows how to define a Programmable Key as a paging dial to page a group.



Note:

- Make sure the group paging feature is enabled – consult your network administrator.
- The feature is not allowed once a user is configured as a delegate for the Boss-Admin feature.

You can define up to five Programmable Keys to page up to five different paging groups. The paging feature allows a live announcement to be made (paged) from a phone to a group of phones, to notify a team (for example) that a meeting is about to commence at a certain venue. The paged announcement is multicast via a designated group IP address, in real time, on all idle phones in the group, without requiring listeners to pick up their receivers. The name of the group is displayed on phone screens when the paging call comes in.

➤ **To define a Programmable Key as a paging dial:**

1. Access the **Programmable Keys** screen (MENU key > **Keys Configuration** > **Programmable Keys**):

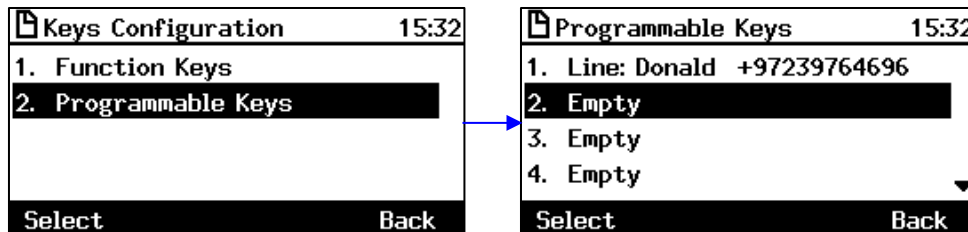

2. Navigate to and select an empty (undefined) Programmable Key; the selected Programmable Key is displayed (#2, in this example):

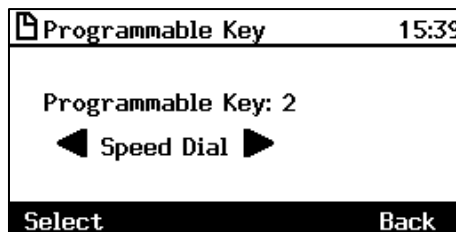

3. Navigate to **Paging** (press the right rim of the navigation control button):

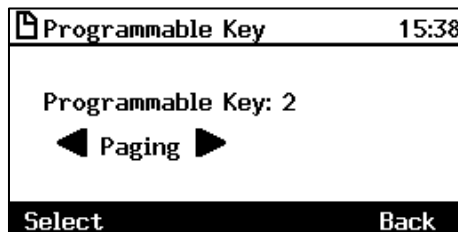

4. Press the **Select** softkey:

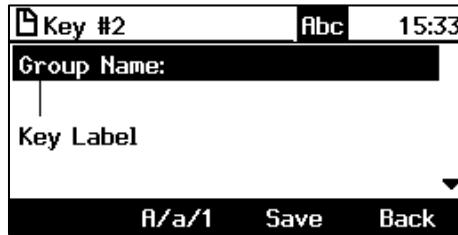

The screenshot shows a phone's configuration screen. At the top, there is a header bar with 'Key #2' on the left, 'abc' in the middle, and '15:33' on the right. Below the header, there is a 'Group Name:' field with a cursor. Underneath is a 'Key Label' field. At the bottom, there are three softkeys: 'A/a/1', 'Save', and 'Back'.

5. In the 'Group Name' field, enter the name of the group, to be displayed in the phone's screen when there's an incoming / outgoing paging call.
6. In the 'Key Label' field, define a name for the Programmable Key-Paging Dial, to be displayed in the phone's screen.
7. In the 'Multicast Address' field, enter the paging group's multicast IP address. Default: 224.0.1.0. For phones to be in a group, all must be configured with the identical multicast address.
8. In the 'Multicast Port' field, enter the group's port. Default: 8888. For phones to be in a group, all must be configured with the identical port.
9. Press the **Save** softkey; the Programmable Key is now configured for paging.

6.20 Defining Programmable Keys as Key Events

You can alternatively define the five Programmable Keys as Key Events. For example, in the figure below, a Programmable Key has been defined as a 'Dialed' Key Event. Pressing the key opposite 'Dialed' opens the Dialed Calls screen:

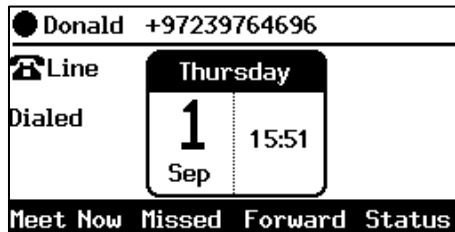

Note: The left uppermost key next to the screen is the preprogrammed phone line. It cannot be defined as a Key Event.

Other Key Events you can define in addition to 'Dialed Calls' are:

- Missed Calls
- Received Calls
- Directory
- DnD All [Do not Disturb. Stops the phone from ringing when others call you. Callers hear a tone indicating that your phone is busy. The call is blocked and your idle screen indicates 'Missed Calls'. Your network administrator must enable DnD before the feature becomes functional on your phone. See the *Administrator's Manual* for more information.]
- Forward All

The section below shows how to define a Programmable Key as a Key Event.

➤ **To define a Programmable Key as a Key Event:**

1. Access the Programmable Keys screen (MENU key > **Keys Configuration** > **Programmable Keys**):



2. Navigate down to an Empty key and select it:

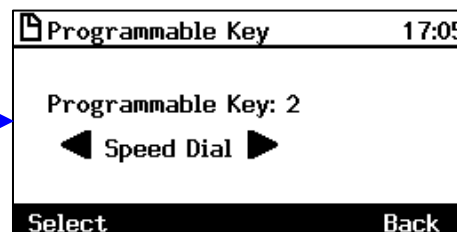
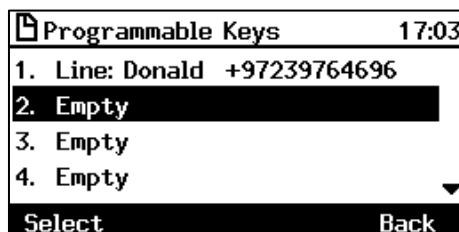

- Press the navigation control's left or right rim to navigate to and select **Key Event**:

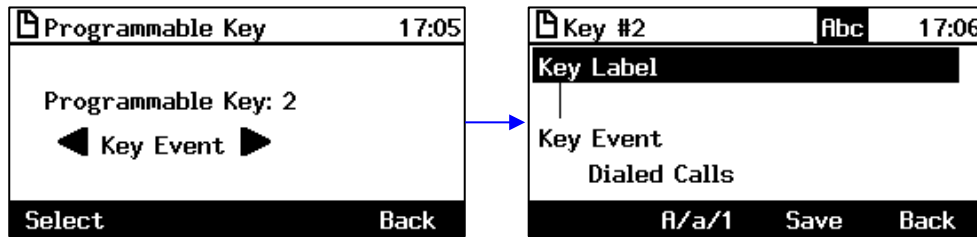

- In the 'Key Label' field, define an identifier that you'll easily identify in the screen, e.g., 'Dialed', as shown in the screen below.
- Navigate down to the 'Key Event' field and then press the navigation control's left or right rim to navigate to and select the Key Event you want to define, for example, 'Dialed Calls':

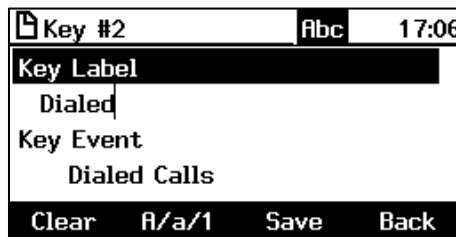

- Press the **Save** softkey; the screen reverts to idle mode displaying the 'Dialed' Key Event you defined ('Dialed', in this example):



6.20.1 Defining Programmable Key #6 as a VocaNOM Speed Dial

You can configure programmable key #6 as a VocaNOM speed dial for quicker and friendlier voice dialing ability.

➤ **To configure VocaNOM Programmable Key #6:**

- Long-press the sixth Programmable Key located to the right of the screen below the fifth and fourth keys; the Programmable Key screen is displayed in the screen.
- Press the navigation control's left rim to navigate to and select the Key Event **Vocanom** as shown in the figure below.

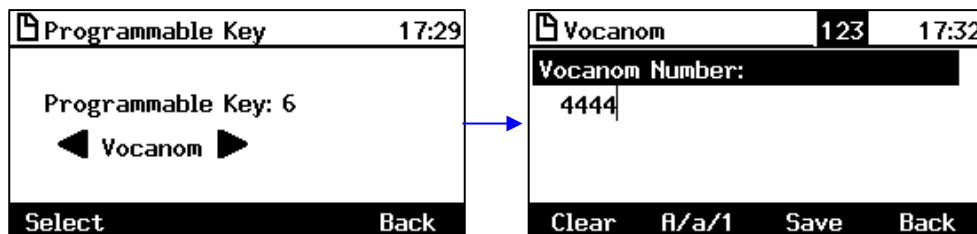

- Enter the VocaNOM Number and press the **Save** softkey; VocaNOM is displayed in the phone screen as shown in the figure below.

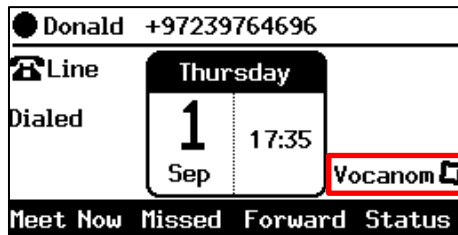

6.20.2 Deleting a Key Event

This section shows how to delete a Programmable Key defined as a Key Event.

➤ **To delete a Programmable Key defined as a Key Event:**

1. Long-press the Programmable Key until this screen is displayed:

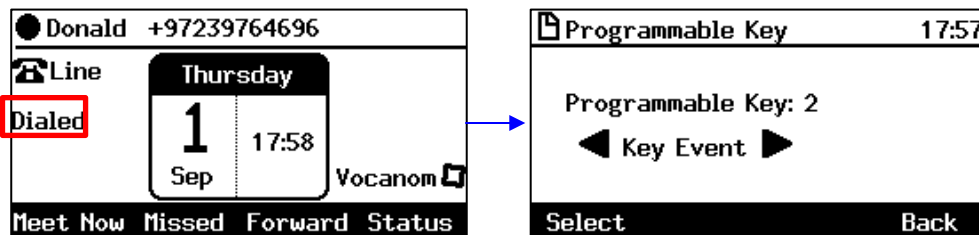

2. Press the navigation control's left or right rim to navigate to and select **Empty**; you're returned to the idle screen; the Programmable Key is removed.

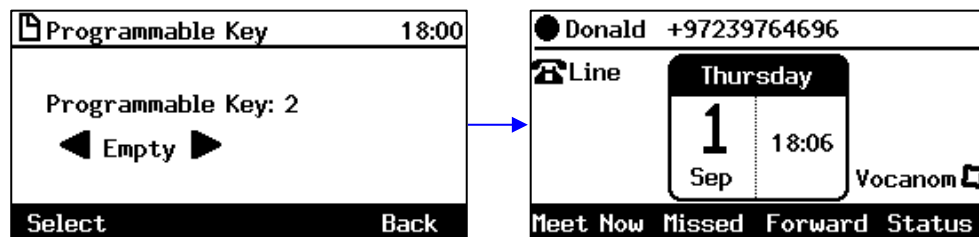

6.21 Changing your Presence Status

You can assign a presence status to control whether you want people to contact you or not, and if so, how. By default, your status is based on your Skype for Business client.



Note:

- Presence status can be changed by your Skype for Business client running on your computer. This status is reflected on the phone's screen.
- After *n* minutes (configured in the Skype for Business server by your administrator), presence status automatically changes to 'Inactive'.
- *n* minutes after this (also configured in the Skype for Business server by your administrator), presence status automatically changes to 'Away'; all calls are then automatically forwarded to the RGS (Response Group Service) if it is configured.

➤ **To set/change presence status:**

1. In the idle screen, press the **Status** softkey:

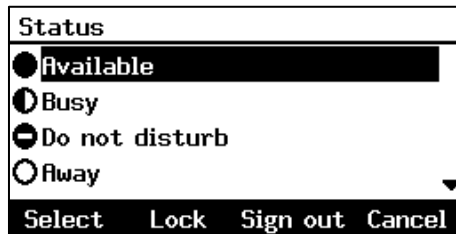

2. Navigate to a presence status:

Table 6-2: Presence Statuses

Presence Status	Description
Available	You're online and available for other contacts to call.
Busy	You're busy and don't want to be interrupted.
Off Work	You're going on vacation (for example).
Appear Away	You want to hide your status and appear to others you're currently away.
Be right back	You' are away briefly and will return shortly.

3. Press the **Select** softkey; the status you selected is displayed in the idle screen:



4. To reset your presence status, navigate to and select **Reset** in the Status screen; your status is received from the Skype for Business server and automatically updated.



Note: If a contact listed in your phone's BLF list is in a call, the red BLF LED on your phone flashes on and off to indicate it.

6.22 Viewing Microsoft Exchange Calendar in the Phone Screen

You can view Microsoft Exchange Calendar items displayed in the phone's screen. Only items whose start date / time falls on the same day are displayed.



Note:

- For this feature to function:
 - ✓ The feature must be enabled by your network administrator if it isn't enabled already (the default is enabled). For more information, see the *Administrator's Manual*.
 - ✓ You need to sign in to the phone with your username and password. If you signed in with your PIN code, the feature will not be available and you'll receive the message below. Features such as this one which are activated from Microsoft's Exchange Server are only available after signing in to the phone with username and password.

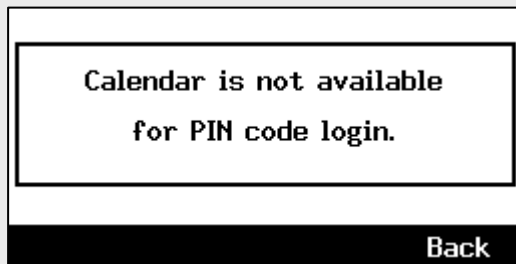

➤ **To your Microsoft Exchange calendar items:**

1. Press the MENU hard key on the phone and in the Menu screen, select the **Calendar** option.

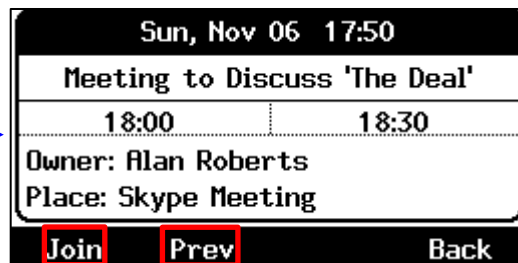
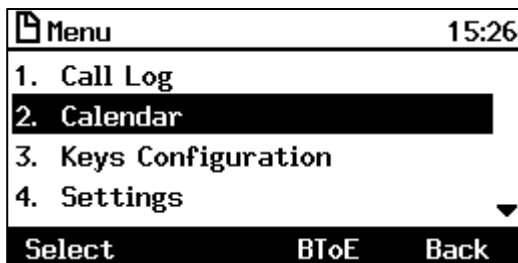

2. You can view other meetings scheduled for that day by scrolling down or pressing **Prev**.
3. You can join in an online Skype for Business meeting such as the one shown in the example above, by pressing the **Join** softkey.
4. In an offline, non Skype for Business meeting such as the one shown below, you can press the **Details** softkey:

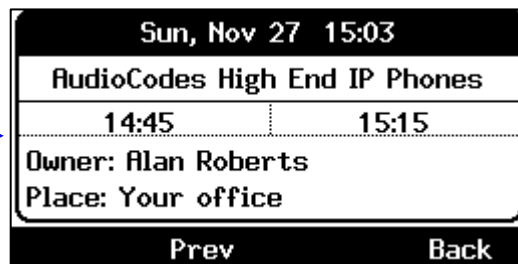
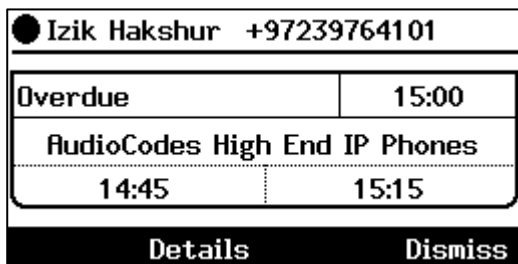

6.23 Receiving Meeting Reminders

The phone automatically pops up meeting reminders for meetings defined as Skype for Business meetings. Meeting reminders pop up in the phone's idle screen at the time defined for them in the meeting invitation.



Note: If the feature is disabled, ask your network administrator to enable it. For more information, see the *Administrator's Manual*.

You can Snooze a Reminder, or Dismiss it. If you select Dismiss, the Reminder does not pop up again; you'll still be able to access Calendar items and view the meeting.

If you select Snooze, the Reminder pops up 10 minutes before the start of the meeting, five minutes before the start of the meeting, and when the meeting begins.

The feature therefore allows you to receive advance notice about meetings and to enjoy direct access to them by clicking **Join**.

This page is intentionally left blank.

7 Performing Basic Operations

This section shows basic phone operations.

7.1 Using Audio Devices

You can use one of the following audio devices on the phone for speaking and listening:

- **Handset:** To make a call or answer a call, lift the handset off the cradle.
- **Speaker** (hands-free mode). To activate it, press the speaker key during a call or when making a call. To deactivate it, press the speaker key again.
- **Headset** (hands-free mode). When talking on the phone, you can relay audio to a connected headset. To enable it, press the headset key. To disable it, press it again.

You can easily change audio device during a call.

- **To change from speaker/headset to handset:** Activate speaker/headset and pick up the handset; the speaker/headset is automatically disabled.
- **To change from handset to speaker/headset:** Off-hook the handset and press the speaker/headset key to activate the speaker/headset. Return the handset to the cradle; the speaker/headset remains activated.

7.2 Checking Voice Quality

You can perform a voice quality check on the phone.

➤ **To perform a voice quality check:**

1. Press the MENU key on the phone, select the **Device Status** menu option and select **Voice Quality Check**.

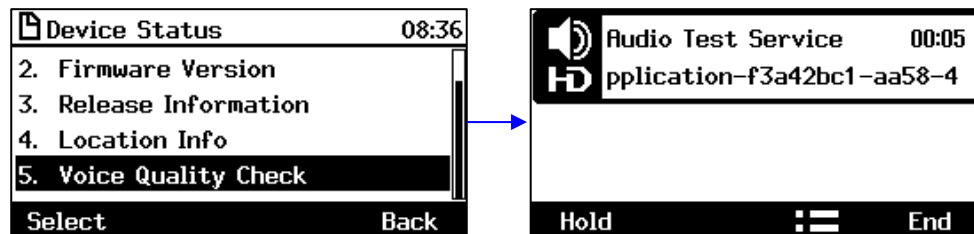

You're invited to "Record a short message after the tone then wait to hear how you sound".



Note: The feature must be enabled on the Skype for Business server by the network administrator for it to be available. See the *Administrator's Manual* for more information.

7.3 Making Calls

The phone offers multiple ways of making a call. After dialing a number:

- The screen displays  and the called party's phone number or contact name if it's listed in the phone directory
- The screen displays the line extension number on which the called party is dialed
- The phone plays a ring-back tone

Screen indications:



➤ **To end dialing a call before it's answered:**

- Press the **End** softkey or the speaker key.



Note: For advanced dialing using the phone directory, see Section 6.14.
For defining a Speed Dial key, see Section 6.16.

7.3.1 Dialing

This section shows how to dial. To dial, either (1) key-in the number on the keypad (2) press the speaker key and enter the number (3) press the speaker key or lift the handset and enter a URL address (e.g., host and domain name, or IP address) or alphabetical letters (e.g., tvservice).

➤ **To dial a regular-digits phone number:**

2. On the keypad, key the first digit of a regular phone number; the screen displays the digit in the NEW CALL field; key in the remaining digits. To delete (from right to left) entered digits, press the **Clear** softkey. To cancel the call, press the **Cancel** softkey.

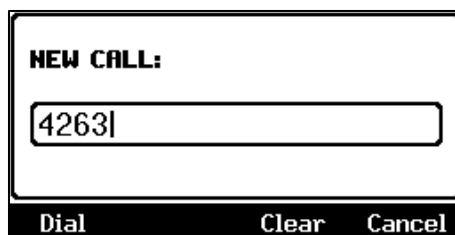

3. Do any of the following:

- Don't do anything; dialling is automatically performed after a few seconds.
- Press the **Dial** softkey; dialling is performed.
- Pick up the receiver; dialling is performed.
- Press the **Speaker** button; dialling is performed.
- Press # (if you switched on speaker/handset/headset before keying in the digits of the phone number); dialling is performed.

➤ **To dial a URL:**

1. Press the speaker key or lift the handset; the screen displays the NEW CALL field and the **URL** softkey:

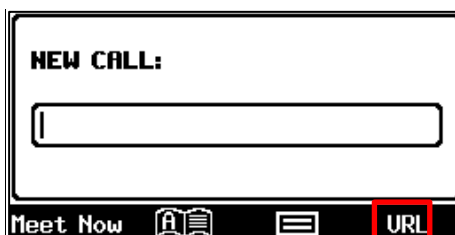

2. Press the **URL** softkey and enter a URL address (see Section 3.4 for how to switch letters, numerals and symbols). To delete (from right to left) entered letters/numerals/symbols, press

the **Clear** softkey. To cancel the call, press the **Cancel** softkey.

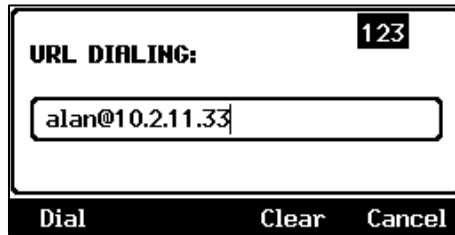

3. Press the **Dial** softkey.

7.3.2 Redialing

You can redial a number previously dialed.

➤ To redial:

1. Press the REDIAL key; the Dialed Calls screen is displayed, listing in chronological order, recently dialed numbers:

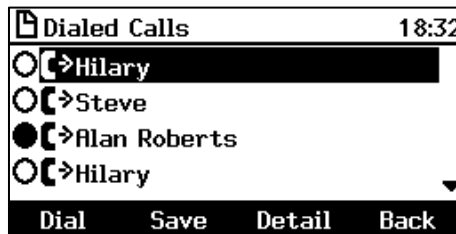

2. Navigate to and select the number to redial.
3. Press the **Dial** softkey or press the **OK** key.

7.3.3 Dialing a Missed Call

The phone logs all missed calls. The screen in idle state displays the number of missed calls.



➤ To dial a missed call:

1. Press the **Missed** softkey; the Missed Calls screen is displayed:



2. Navigate to the missed call to dial if there are more than one listed.
3. Press the **Dial** softkey or press the **OK** key.

7.4 Answering Calls

The phone indicates an incoming call as follows:

- The screen displays  together with the caller's phone number (or contact name if listed in the phone directory):



- Phone rings.
- Ring LED flashes blue.

➤ **To answer:**

- Pick up the handset-OR- press the headset key (ensure that the headset is connected to the phone) -OR- press the speaker key -OR- press the **Accept** softkey (the speaker is automatically activated)

When you answer, the screen displays the  icon and the caller's details and call duration:

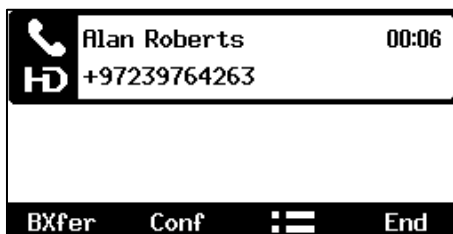

Note:

- **HD** in the screen indicates a high-definition call (using a wideband voice coder).
- If a contact is in a call and they're listed in your phone's BLF list, the red BLF LED flashes on and off to indicate that the contact is in a call. If that contact is in a call with another contact listed in your phone's BLF list, the red BLF LEDs of both the calling contact and the called contact flash on and off on your phone.
- When two incoming calls occur simultaneously, the names of the calling parties appear on the screen and the adjacent incoming call icons flash. If a user is in a call and a third party calls, the name of the calling party appears on the screen and the adjacent incoming call icon flashes.

7.5 Rejecting Incoming Calls

You can reject an incoming call; the caller hears a busy tone from your phone if you do.

➤ **To reject an incoming call:**

- Press the **Reject** softkey.



Note: If your enterprise network administrator has activated voicemail on your phone, you can send the incoming call directly to voicemail. See details below.

➤ **To send an incoming call to Voicemail:**

- When the phone rings to alert to an incoming call, press the **To VM** softkey that is displayed.



➤ **To view voicemail content:**

1. Press the voicemail key on the phone, indicated by an envelope icon which will be illuminated red if you have voicemail; this screen is displayed:

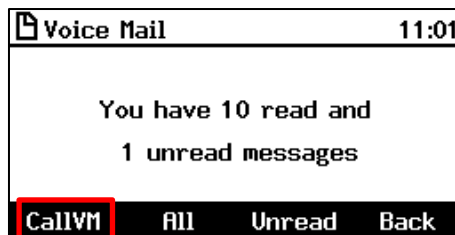

2. Press the **CallVM** softkey

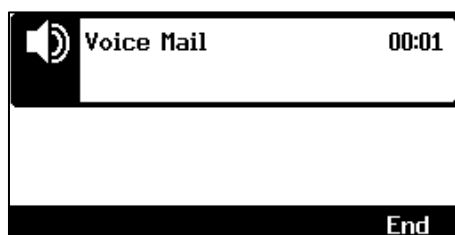

3. Listen to your messages played back to you and then (optionally) press the **End** softkey.

7.6 Silencing Incoming Calls

You can silence an incoming call's ringing; the caller hears normal ringing but no answer.

➤ **To silence the ringing of an incoming call:**

- Press the **Silent** softkey.



Answer a silenced call by pressing the **Accept** softkey or picking up the handset.

7.7 Making a New Call Even Though a Call is Coming in

Users can make a new call even though a call is coming in. This is typically necessary when it is more important and more pressing to make a new call than to accept the incoming call.

➤ **To make a new call when a call is coming in:**

1. In the INCOMING CALL (Donald) screen, press the **New Call** softkey:

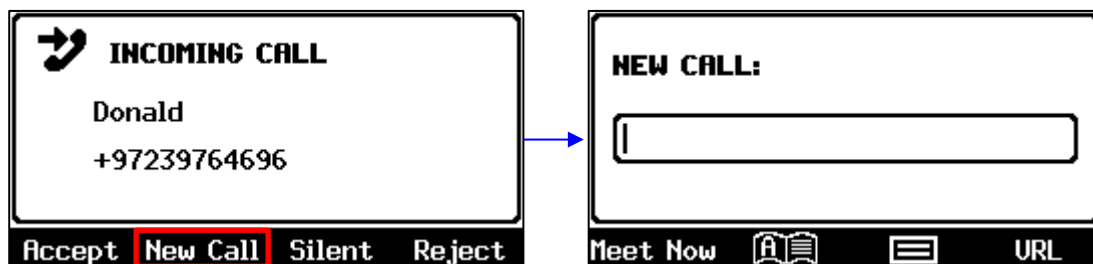

2. In the NEW CALL screen, enter the number of the destination to which to call, and press the then-enabled **Dial** softkey. If necessary, you can clear digits entered / cancel the new call.

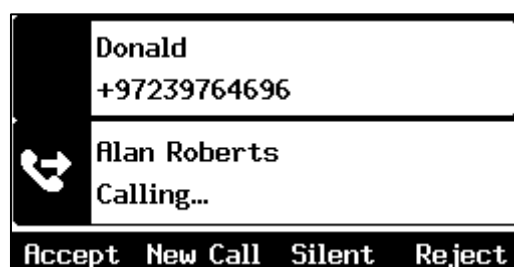

3. When the called party answers, you can toggle to the calling party and reject or accept them.

7.8 Ending an Established Call

You can end an established call.

➤ **To end an established call:**

- Return the handset to the phone cradle if it was used to take the call -or- press the headset key -or- press the speaker key -or- press the **End** softkey.

7.9 Viewing Missed, Received and Dialed Calls

The phone logs calls missed, received and dialed calls.



Note:

- The phone's Call Logs are synchronized with Microsoft's Exchange server. All lists in each device's Call Log are synchronized except the Missed Calls list. All devices that a user signs into are synchronized with the server. Each device reports every call from | to that user to the server. Each device then pulls the last 20 reported calls and performs synchronization.
- If the feature has been disabled, the network administrator must re-enable for synchronization to function. See the *Administrator's Manual* for more information.

In idle state, the screen displays the number of missed calls (if any). In the example below, 3 missed calls are indicated.



➤ **To view missed calls:**

- Press the **Missed** softkey.



Note: After viewing, the indication disappears from the screen. The next time a call is missed, the indication will reappear.

➤ **To view call history:**

1. Access the Call Log screen (MENU key > **Call Log**).
2. In the Call Log screen, navigate to and select the call log you require.

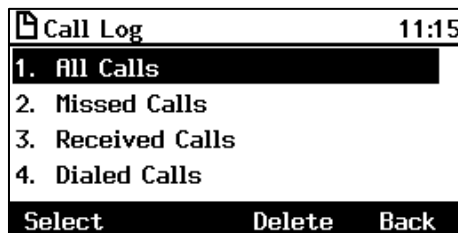

- **All Calls** = calls that were missed, received and dialed
- **Missed Calls** = calls that were not answered
- **Received Calls** = the most recently answered numbers
- **Dialed Calls** = the most recently dialed numbers

3. Navigate to the option you want and press the **Select** softkey; a list of the logged calls is displayed, for example, Dialed Calls:

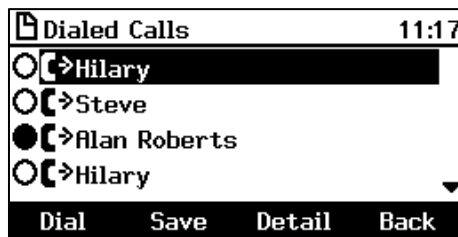

4. Press the softkey you need:
 - **Dial** = dials the number of the selected logged entry.
 - **Save** = saves the related information about the call entry in the personal directory (for adding a contact in the directory, see Section 6.14).
 - **Detail** = accesses the Call Details screen, which displays details of the call entry:

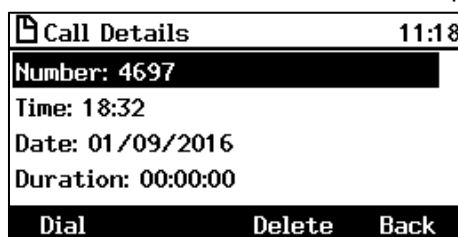

The Call Details screen displays the following logged call information:

- **Number** = phone number logged
- **Time** = the time the call was logged
- **Date** = the date on which the call was logged
- **Duration** = the duration of the call



Notes:

- The call history lists are stored from the newest to oldest entries. The maximum number of entries for each call history type is 200. Once this maximum is attained, the oldest entry is deleted and replaced with the new entry.
- The call history lists are saved on a daily basis. In the case of a power outage, some of the received information may be lost.
- If you view missed calls by pressing the **Missed** softkey, the missed calls notification no longer appears on the screen and reappears the next missed call.

7.10 Reporting a Malicious Call

You can report a malicious call. If you receive a call and you want to report it as malicious, the phone allows you to send a report to the Skype for Business server.



Note: The feature must be enabled by the network administrator on the Skype for Business server for malicious call reporting to be allowed by the phone. See the *Administrator's Manual* for more information.

➤ **To report a malicious call:**

1. After receiving a call, press the MENU key on the phone and select the **Call Log** item.
2. Select the **Report a call** option; the phone reports the malicious call.

7.11 Paging

You can page others in your group and they can page you after configuring the group and the paging dial on the phone.

For detailed information on setting up a paging group, see Sections 6.17 and 6.19.

7.11.1 Performing Outgoing Paging Calls

You can page others in your group. You can use the speaker, handset or headset as the audio device.

➤ **To page others in your group:**

1. Press the key that you assigned to the group for paging (Function Key or Programmable Key); your phone displays this:

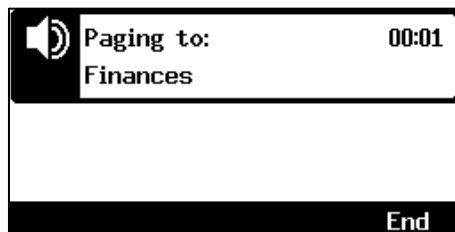

2. Pick up the receiver and make the announcement (or talk directly into the speaker).

7.11.2 Receiving Incoming Paging Calls

Others in your group can page you.

➤ **To receive a paging call from another in your group:**

1. View in your phone's screen which group (member) is paging you and listen for the incoming paging call:

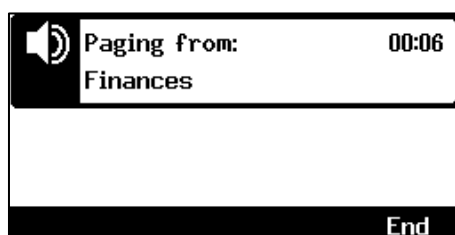



Note: If you're in a call when the paging call comes in and the 'Barge-in' feature was disabled (default) by your IP Administrator, you're prompted to accept/reject the paging call (see below).

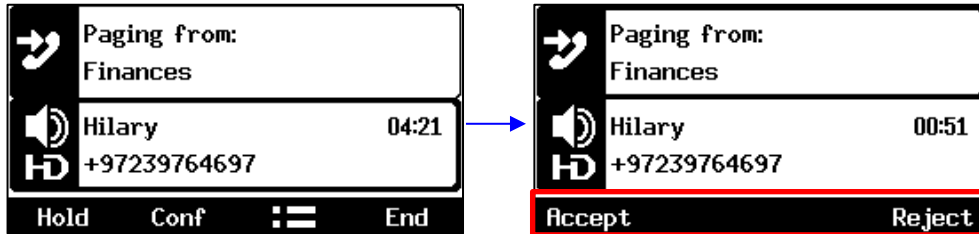

2. Navigate from the regular call to the paging call and then press the **Accept** softkey to hear it; the regular call you were in is put on hold.

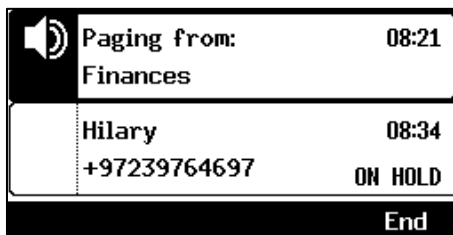

Note: If you would have pressed the **Reject** softkey, you would have continued in the regular call and not heard the paging call.

3. Press the **Resume** softkey when the paging call ends.



Note: If you're in a call when the paging call comes in and the 'Barge-in' feature was *enabled* by your network administrator, the regular call is automatically eclipsed by the paging call (see below).

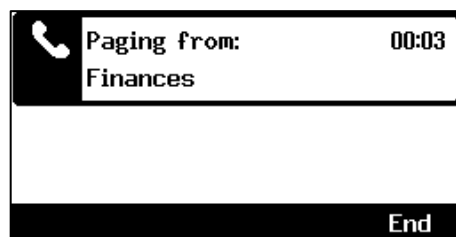

4. Press the **End** softkey (optional); the regular call is put on hold.

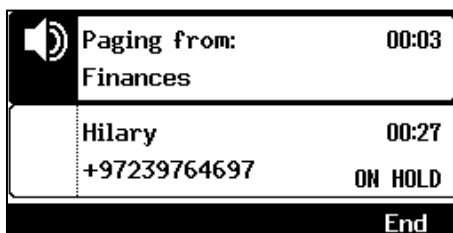

5. Press the **Resume** softkey; the regular call is resumed.

8 Performing Advanced Operations

This section shows how to perform advanced operations.

8.1 Answering Waiting Calls

You can accept a call on an extension on which there already is an active call.

➤ **To answer a waiting call:**

- a. A call with Steve is in progress



- b. A call comes in from Hilary



 = call waiting

➤ **To answer Hilary:**

1. Press the **Accept** softkey; the waiting call from Hilary is answered; the previous call from Steve is put on hold:



2. To toggle between calls, press the navigation control's upper or lower rim.



Note: To enable / disable the call waiting feature, see Section 6.3.

8.2 Placing Calls On Hold

You can place a call on hold in order to answer an incoming call (see Section 8.1) or to make another call. The party put on hold will hear music played (Music on Hold (MOH)).

➤ **To place a call on hold:**

- Accept an incoming call and then press the HOLD key on the keyboard or press the **Hold** softkey; the call is put on hold:

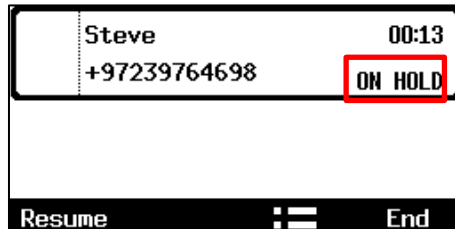

➤ **To retrieve a call on hold:**

- Press the **HOLD** key again -OR- press the **Resume** softkey.



Note: When using the handset in a call, if the handset is on-hooked after putting the call on hold, the call is *not* disconnected and the *audio is switched to the speaker*. For the call to be *disconnected*, as it was in earlier versions, refer to your network administrator.

8.3 Handling Multiple Incoming Calls

The phone is capable of handling up to eight concurrent calls per line. Multiple calls can be put on hold and you can switch between them. This feature is important for front desk personnel.

➤ **To manage multiple incoming calls:**

- If a call comes in from Hilary and then after it, a call comes in from Steve, when you answer Steve, Hilary is put on hold.
- If a third call comes in, this one from Alan, and you answer it, Steve is also put on hold, so now both Hilary (caller 1) and Steve (caller 2) will be on hold.

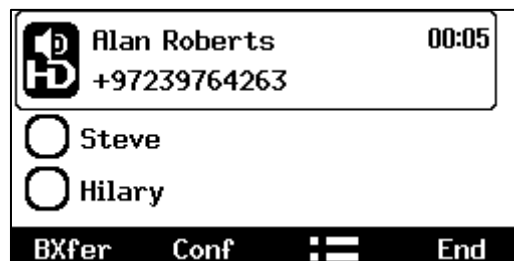

➤ **To toggle between callers:**

- Press the upper or lower rim of the control button to navigate from one caller to another.

8.4 Calling a Contact from 'Favorites'

You can directly call from the phone any contact that is listed in your Skype for Business client's 'Favorites'.

➤ **To call a contact listed in 'Favorites':**

1. Press the CONTACTS key.



2. Navigate to a contact to call and then press the **Dial** softkey or the **OK** hard key.

8.5 Using a Speed Dial to Call

You can press a Function Key or a Programmable Key, that you defined as a Speed Dial, to quickly place a call. To define a Function Key as a Speed Dial, see Section 6.16. To define a Programmable Key as a Speed Dial, see Section 6.17.

➤ **To place a call using a Speed Dial:**

- Press a Function Key (1-12 on the right side of the phone) that you defined as a Speed Dial; the phone dials the defined contact's number -OR-
- Press a Programmable Key (the six flanking the screen with the exception of the uppermost left key) that you defined as a Speed Dial; the phone dials the defined contact's number.



Note: If you haven't defined Function Key #8 (for example) as a Speed Dial and you press it, the screen displays the Function Key #8 screen enabling definition. If you haven't defined a Programmable Key and you long-press it, the Line Key screen is displayed enabling definition. See Section 6.16 and Section 6.17.

8.6 Transferring Calls

You can transfer a call to another party using blind transfer (default) or consultation transfer.

Transfer	Description
Blind	Connects another party to a third party <i>before</i> the third party answers.
Consultation	Connects another party to a third party <i>after</i> the third party answers and agrees to take the call from the second party.



Note:

- The hard TRANSFER key on the phone *by default* performs a *blind transfer*.
- Your network administrator can change the key's functionality to *consultation transfer*. See the *Administrator's Manual* for more information.

8.6.1 Performing a Blind Transfer

You can transfer a call to a destination party without consulting them.

➤ **To perform a blind transfer:**

1. Steven asks you – Donald - to transfer him to Hilary. Press the TRANSFER hard key on the phone or press the **BXfer** softkey. Steven is put on hold.

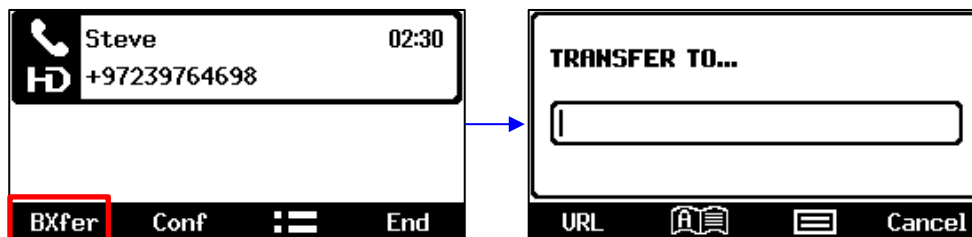

2. In the TRANSFER TO screen that opens, enter Hilary's number (4697) and then press the **Trans.** softkey.

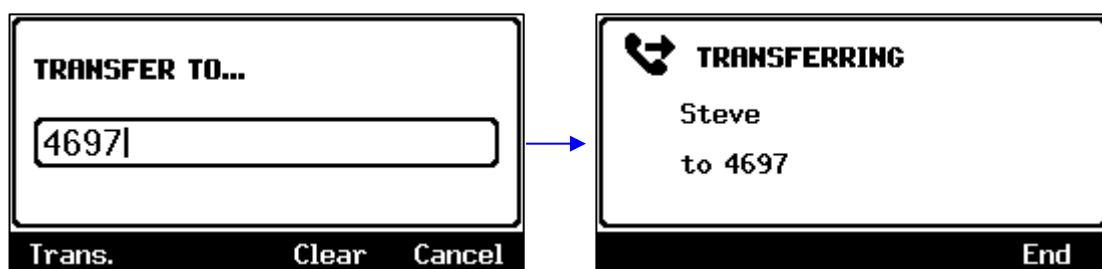

3. Hilary's phone rings. When she picks up, your phone is disconnected from Steve who is transferred to Hilary:



8.6.2 Performing a Consultation Transfer

You can consult with a party before transferring the call to them.

➤ **To perform a consultation transfer:**

1. In a call with Steve, he asks you – Donald - to transfer him to Hilary. Press the **☰** softkey.

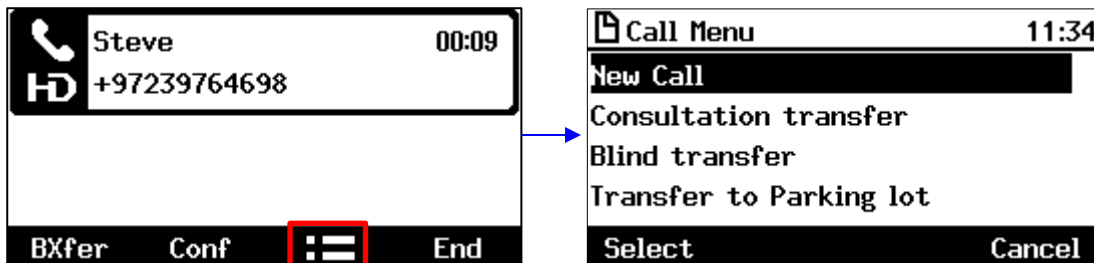

2. Scroll down in the Call Menu to select **Consultation transfer**.

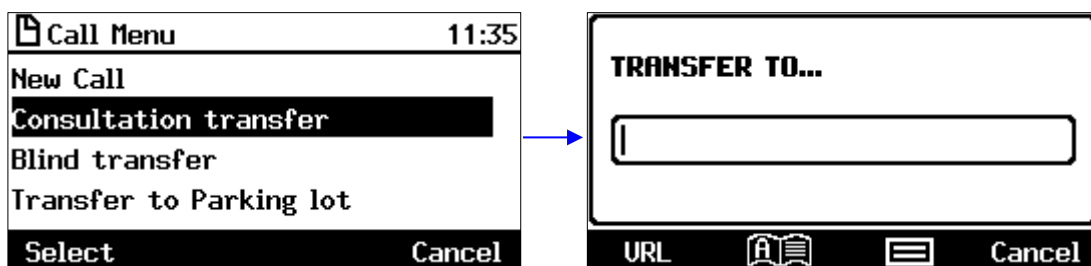

3. In the TRANSFER TO field, enter Hilary's number and press the **Dial** softkey; Hilary's phone rings and Hilary answers:

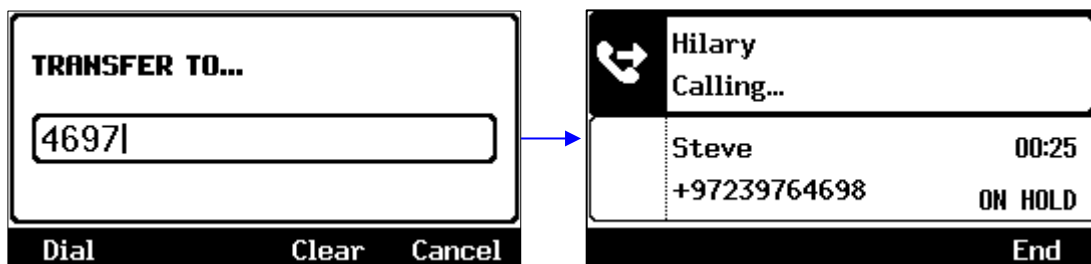

4. Press the **Trans.** Softkey or press the TRANSFER hard key on the phone.

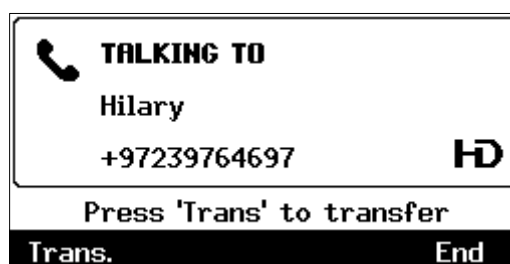

Hilary is connected to Steve.

8.6.3 Performing a Semi-Consultative Transfer

Instead of consulting extensively with the destination party after they answer, you can transfer the call when they say hello. Semi-consultative transfer allows you to identify the voice of the destination party before transferring the call to them, without asking them whether they agree to take the call or not.



Note: The feature is by default disabled. For the feature to be available, your enterprise network administrator must enable it on the phone. See the *Administrator's Manual* for details.

➤ **To perform a semi-consultative transfer:**

1. Steve asks you – Donald - to transfer him to Hilary. Press the **☰** softkey, as shown above, and select the **Consultation transfer** option:

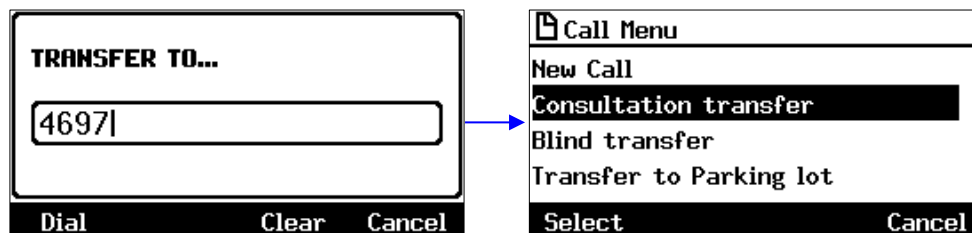

2. Enter Hilary's number and press the now-enabled **Dial** softkey. Steve is put on hold. MoH is played to him.

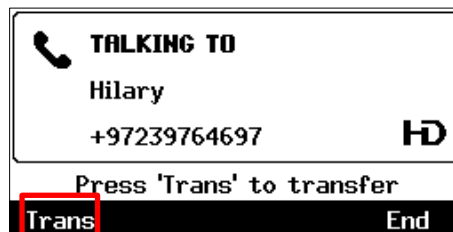

3. When Hilary answers, press the **Trans** softkey or press the TRANSFER hard key on the phone; Hilary is connected to Steve.



Note: If your network administrator has not enabled the feature, the **Trans** softkey will not be displayed.

8.6.4 Merging Calls

You can merge two separate calls into one conference call if you're in a call and you want to add another participant to the established call.

Merging therefore is in effect similar to adding a participant to a conference. It can be performed via the phone's menu softkey or via the Skype for Business client if the user is paired.

➤ **To merge calls:**

1. While in a call with Steve, you (Donald) decide you want to add Hilary to the conversation. Press the **☰** softkey and then select **New Call**.

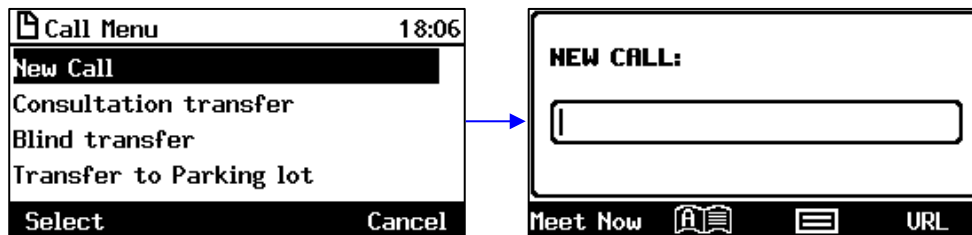

2. In the New Call field, enter Hilary's number and press the now-enabled **Dial** softkey.

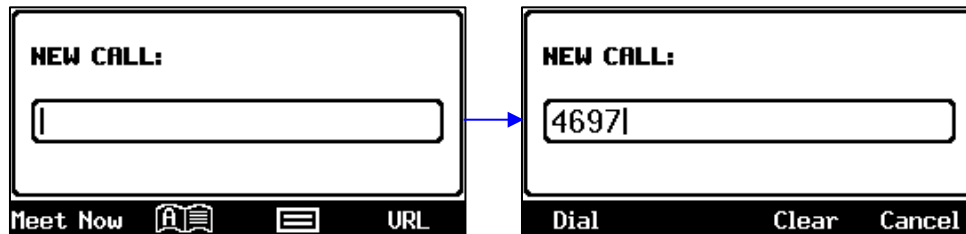

3. When Hilary answers, press the **☰** softkey and then select **Merge Calls**; all three of you are now in the conversation.

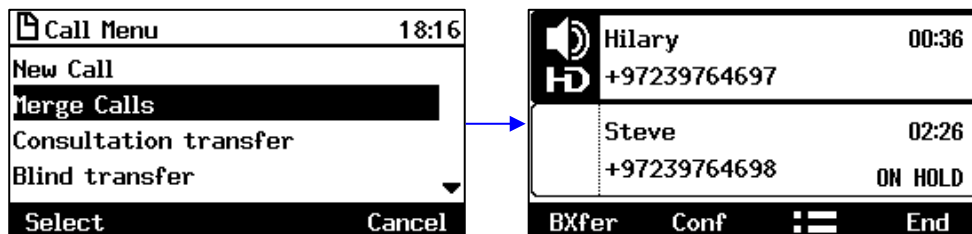

8.7 Parking a Call

You can park a call, i.e., you can transfer a call to a "parking lot" for it to be picked up on any other phone in the enterprise by a party who must dial a retrieval number in order to retrieve it on that phone. The retrieval number is configured in the Skype for Business server's parking lot parameter. Your network administrator can change the retrieval number if required.



Tip: Don't park a call unless you know precisely who you want to answer it. If you park a call, it can be answered by anyone in the enterprise listed in the Skype for Business server's parking lot parameter.

➤ To park a call:

1. When you're in the call, press the **☰** softkey and then navigate to and select the **Transfer to Parking Lot** option:

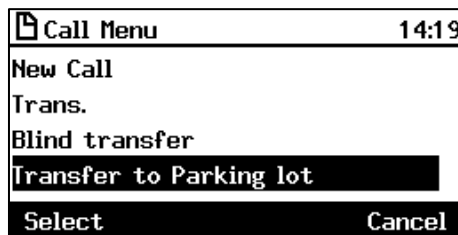
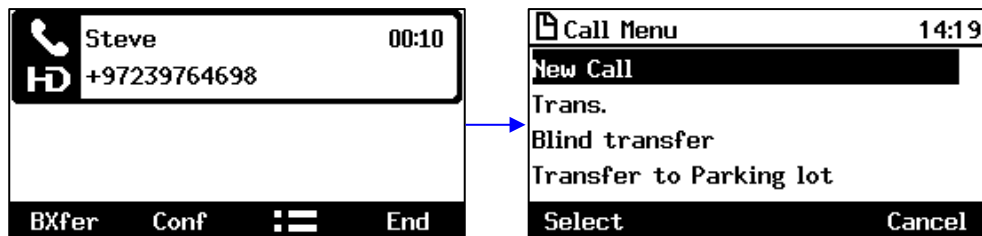

The screen notifies you of the retrieval number to dial to retrieve the call on another phone:

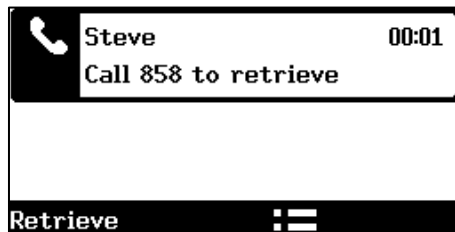

2. On another phone, dial the retrieval number (**858** in the example above); the call is pulled to that phone.
3. You can pull the call back to the phone which it originally was on by pressing the **Retrieve** softkey.

8.8 Configuring Group Call Pickup (GCP)

GCP capability lets an employee take a call coming in on a colleague's phone, on their phone. If an employee in an open space hears a colleague's phone ringing and knows that colleague is unavailable, instead of having the call go unanswered and routed to voicemail, the call can be redirected and answered by the available employee. Only employees configured in the Skype for Business server's GCP parameter can pick up the call. Consult your network administrator if required.

8.9 Initiating a Multi-Party Skype for Business Remote Conference

A multi-party call conference based on the Skype for Business server (remote conference) can be initiated from the phone.



Note: This section describes conferencing when Better Together over Ethernet (BToE) is *not* installed. See Section 8.2.4 for information about conferencing when BToE *is* installed.

In versions preceding 3.0, supported conference capability was *locally based* (phone based). As of version 3.0, the phone of the conference initiator uses CCCP (Centralized Conference Control Protocol) to establish the conference. The feature is integrated with Microsoft Exchange so in an email invitation to join a Skype for Business meeting, you can click a **Join** link.

➤ **To initiate a conference:**

1. In the phone's idle screen, press the **Meet Now** softkey; the CONFERENCE screen opens indicating **No Participants**.

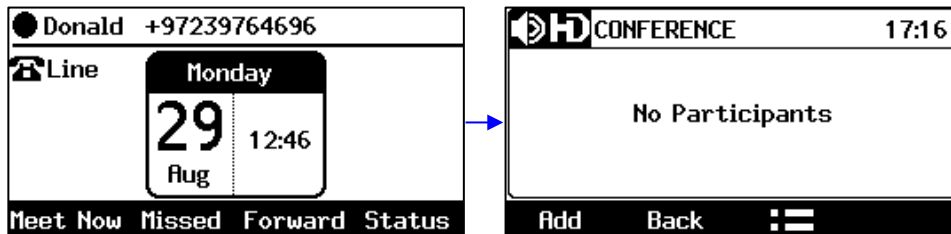

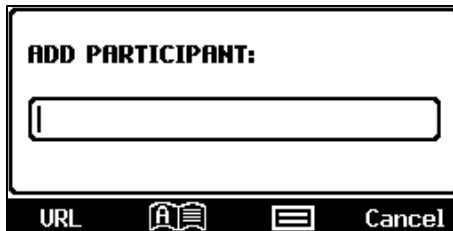

3. Press the **Add** softkey; the ADD PARTICIPANT screen opens.

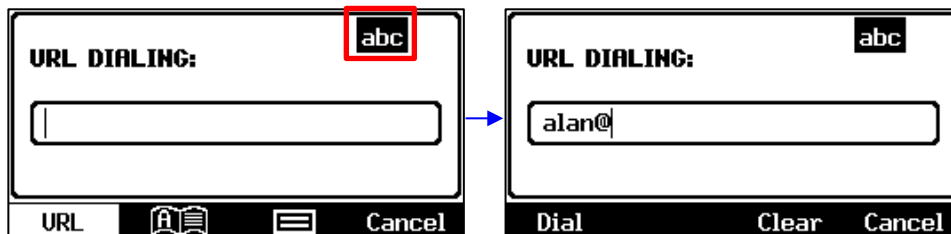

4. Enter the participant's phone number. Either:
 - Press the **URL** softkey, use the alphanumerical selection displayed to enter the participant's URL (see Section 3.4 for more information), and then press the **Dial** softkey.



- Press the  softkey; the contacts added to 'Favorites' in the Skype for Business client are displayed by default. If the contact you are searching for is not in your 'Favorites', press the  softkey and navigate in the Corporate Directory, Personal Directory, Outlook Contacts or Others to find them (see Sections 6.14 and 6.15 for more information). After finding them, select and then press the **Dial** softkey.

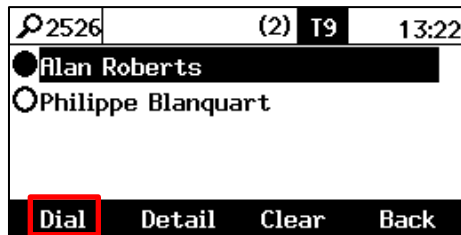

- Press the  softkey, choose a Call Log (e.g., Dialed Calls, shown below), navigate to the participant and then press the **Dial** softkey (see Section 7.9 for more information about the Call Logs).

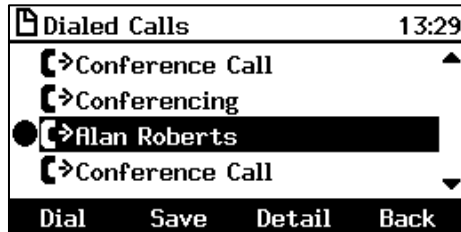

5. After adding and dialing a participant, add and dial the other participants to include in the conference.

➤ **To view conference participants:**

- In the phone's idle screen, press the **Meet Now** softkey to open the CONFERENCE screen.

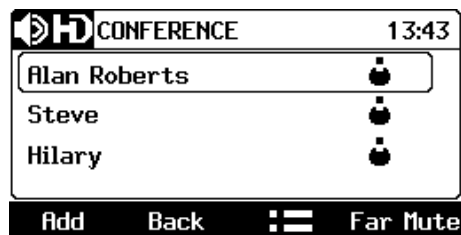

➤ **To remove a conference participant:**

- In the CONFERENCE screen, navigate to the participant to remove, and then press the softkey. In the Call Menu screen that opens, select the **Remove** option.

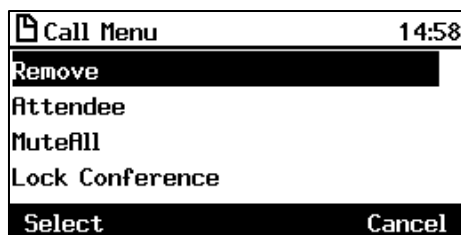

➤ **To change a participant's privileges:**



Note: The icon adjacent to each participant in the CONFERENCE screen indicates that that participant has got 'host' privileges (relevant only to Skype for Business users rather than to PSTN/mobile calls, for example):

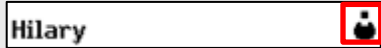

Participants with 'host' privileges can perform every action: far mute, mute all, remove, etc. Participants with 'attendee' privileges can only add participants, no more.

1. In the CONFERENCE screen, navigate to the participant whose privileges you want to change, and then press the **≡** softkey.

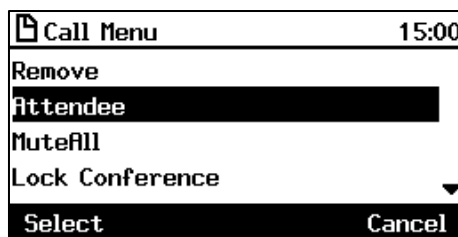

2. In the Call Menu screen that opens, select the **Attendee** option; the participant's privileges will change to 'attendee' privileges and the icon indicating 'host' privileges in the CONFERENCE screen will disappear.

➤ **To mute all participants:**

- In the CONFERENCE screen, press the **≡** softkey and in the Call Menu screen that opens, select the **MuteAll** option.

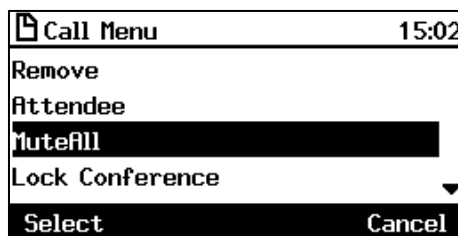

➤ **To lock a conference:**

- In the CONFERENCE screen, press the **≡** softkey and in the Call Menu screen that opens, select the **Lock Conference** option.

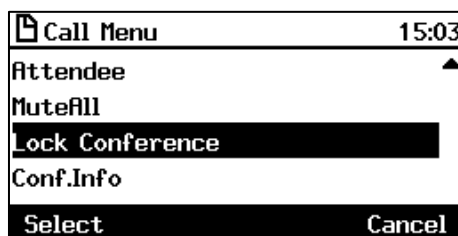

➤ **To view conference information:**

- In the CONFERENCE screen, press the  softkey and in the Call Menu screen that opens, select the **Conf.Info** option.

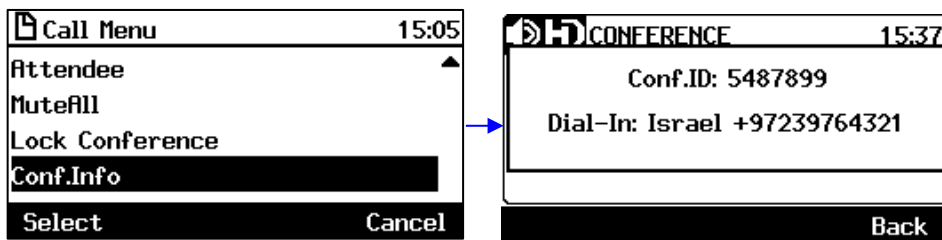

➤ **To mute a remote participant:**

- In the CONFERENCE screen, navigate to the participant to mute and then press the **Far Mute** softkey.

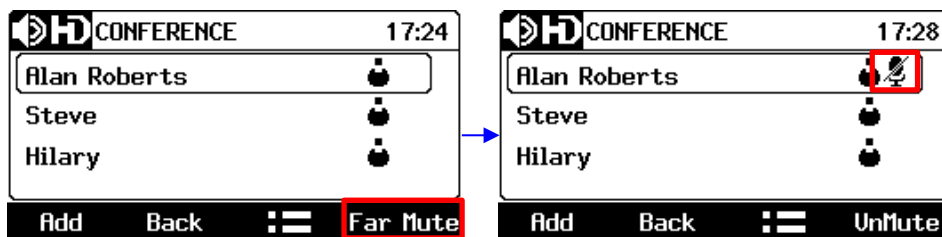

On the participant's screen, the mute key illuminates red and the following message is displayed: **A presenter has muted you**

➤ **To unmute a remote participant:**

- In the CONFERENCE screen, navigate to the participant to unmute and then press the **UnMute** softkey.

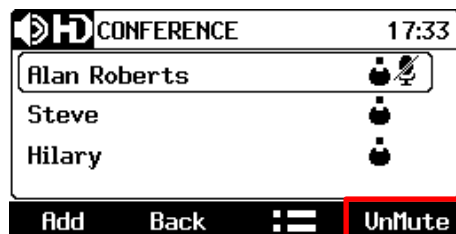

On the participant's screen, the following message is displayed: **A presenter wants you to unmute yourself**. The participant should press the illuminated mute button on their phone to unmute.

8.10 Muting Calls

You can mute the microphone of the handset, headset, or speakerphone during a call so that the other party cannot hear you. While the call is muted you can still hear the other party. Muting calls can also be used during conference calls, as described above.

➤ **To mute/unmute:**

1. During a call, press the mute key: 
2. To unmute, press the mute key again and resume the conversation.

8.1 Setting up Better Together over Ethernet

This section shows how to set up the Microsoft Skype for Business feature 'Better Together over Ethernet' on AudioCodes' 400HD Series of IP Phones.

BToE enables operations to be mirrored on both AudioCodes' IP phone and the Skype for Business client on the PC/laptop, so that these operations can be controlled from either the IP phone or the PC/laptop, whichever is convenient to the user at the time, for enhanced unified communications and optimized enterprise efficiency.

After your IP phone is paired with your Skype for Business client, you can control (from phone or PC/laptop) operations such as answering incoming calls, making outgoing calls (click-to-dial), putting calls on hold and resuming them, and making conference calls.

8.1.1 Installing the BToE PC/Laptop Application

This section shows how to install AudioCodes' BToE PC/laptop application.

➤ **To install the BToE PC/laptop application:**

1. After obtaining the installation file whose name will be either *AudioCodes BToE.exe* or *AudioCodes BToE.msi*, save it to your PC/laptop and then double-click it.

Note:

- The *msi* file is for the purpose of network administrator distribution. Users are not allowed to install BToE using the *msi* file, only using the *exe* file.
- After installing with the *exe*, then when upgrading the *exe* must be used. Upgrading with the *msi* cannot be done if the first installation was with the *exe*, and vice versa.
- Some PCs require the installation of .Net 4.0 prior to the installation of the BToE PC/laptop application. If you use the installation file *AudioCodes BToE.exe*, the Installation Wizard will detect that .Net 4.0 is missing and will prompt you to install it:

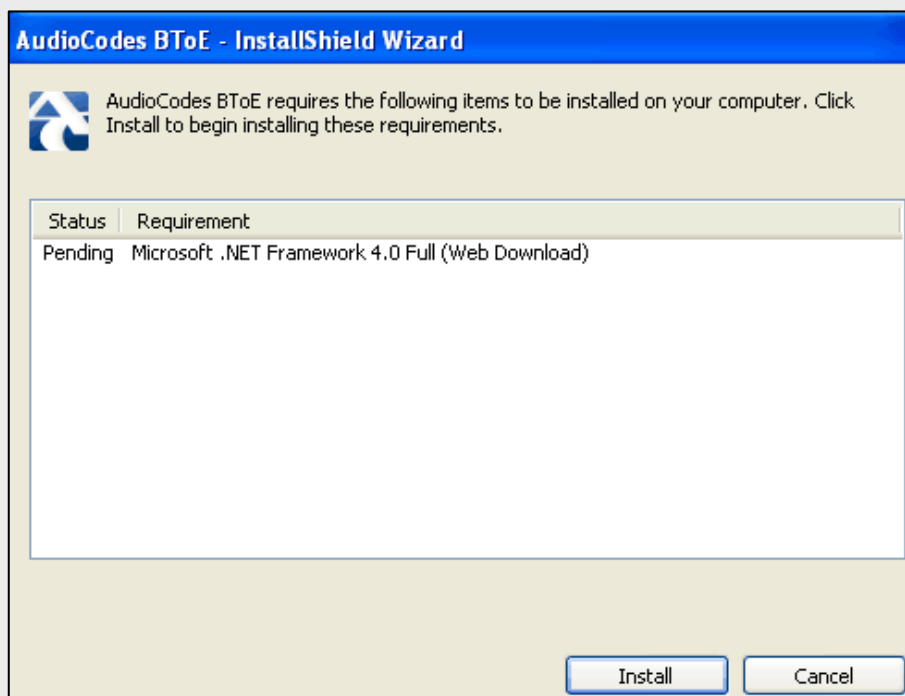

When installing the BToE PC/laptop application using the installation file *AudioCodes BToE.msi*, you won't be prompted to install .Net 4.0 and the network administrator should make the necessary preparations prior to installation of the BToE PC application.

The Prepare to Install screen opens showing preparation progress until the Welcome to the InstallShield Wizard screen opens:

Figure 8-1: InstallShield Wizard – Preparing to Install

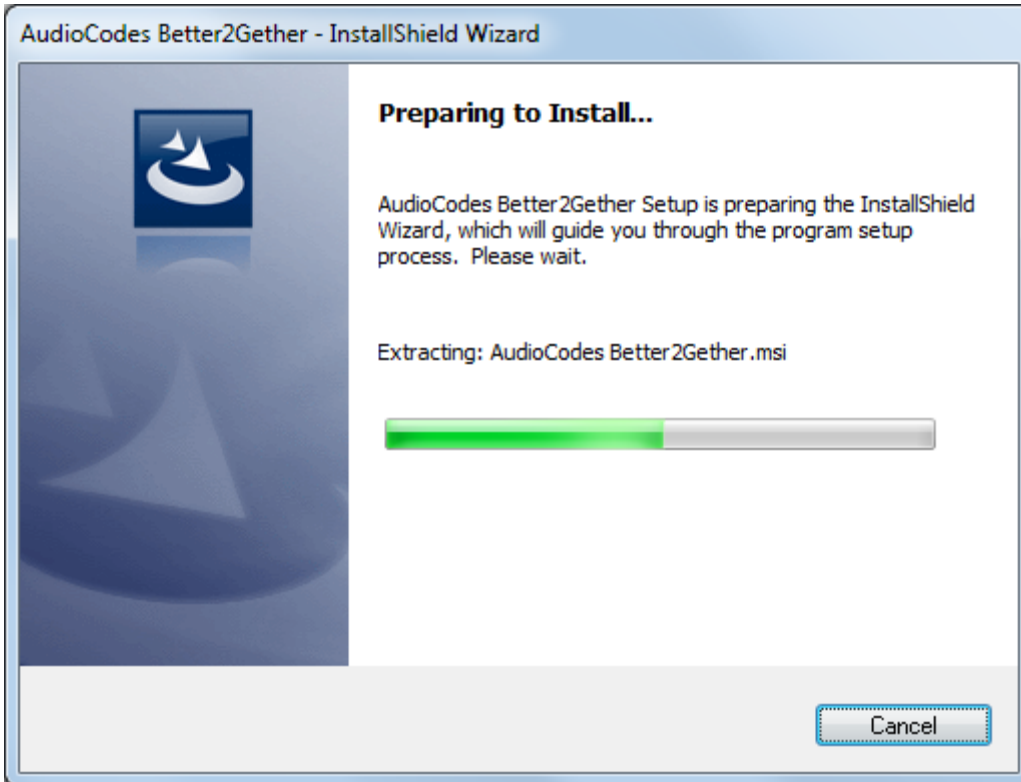
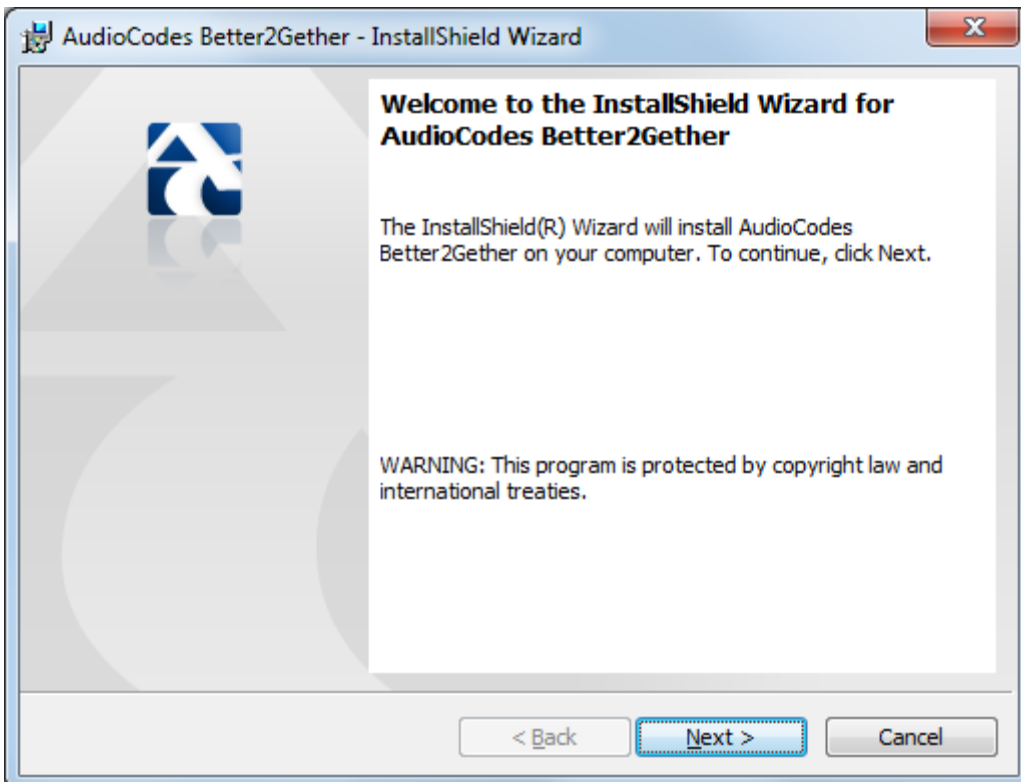
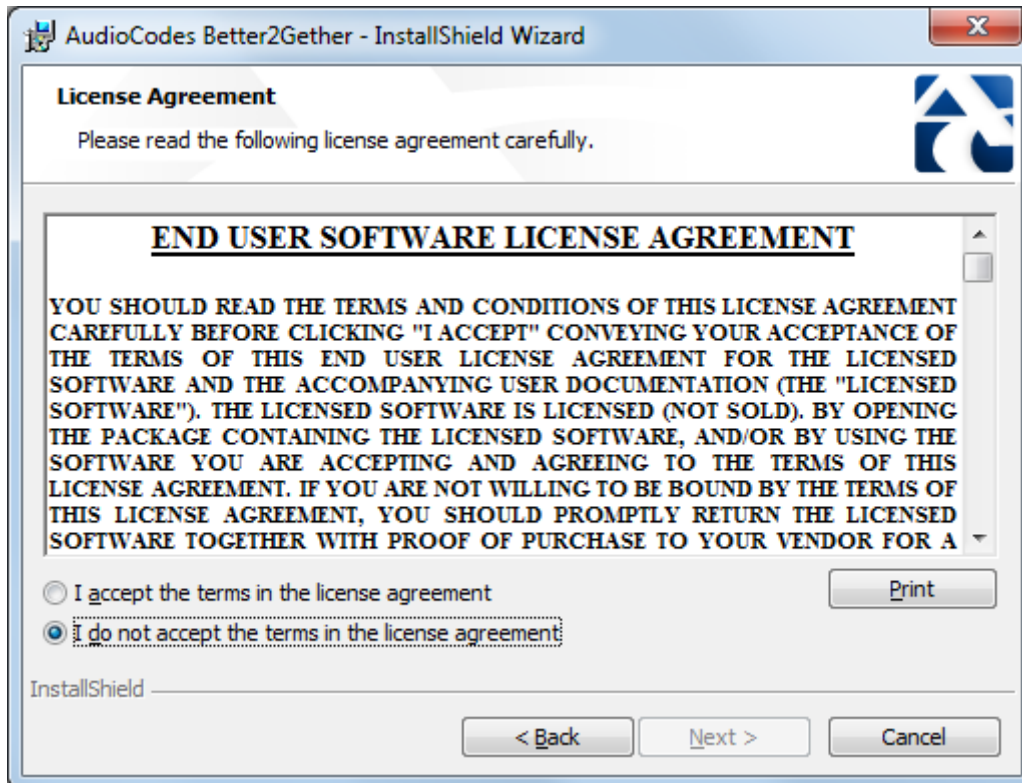

Figure 8-2: Welcome to the InstallShield Wizard



2. Click the **Next** button; the License Agreement screen opens.

Figure 8-3: License Agreement



3. Select the **I accept...** option and click **Next**.

Figure 8-4: License Agreement

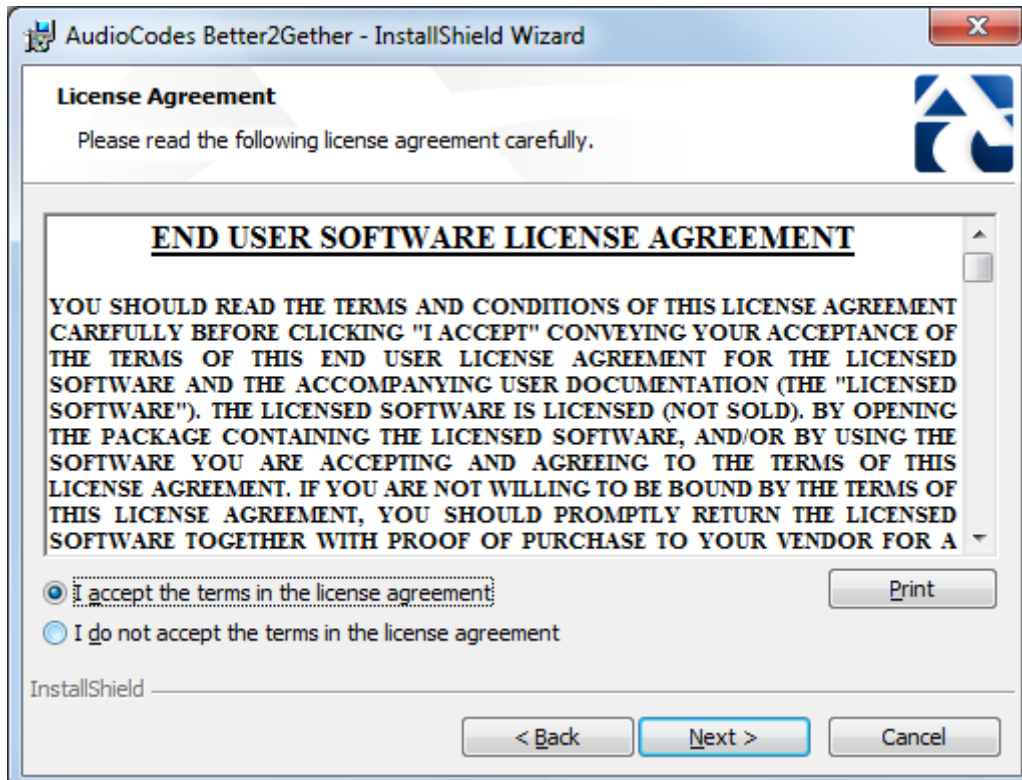

4. Click **Next**; the Destination Folder screen opens.

Figure 8-5: Destination Folder

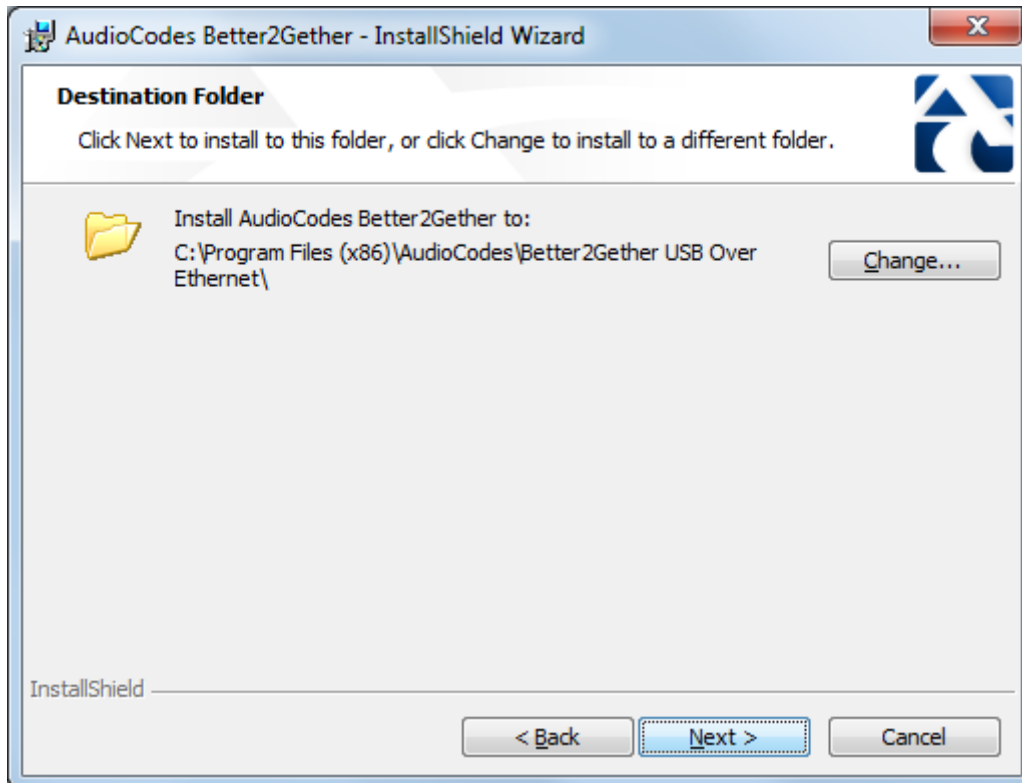

5. To change the default Destination Folder, click **Change** and proceed to step 6. To leave the Destination Folder at its default, click **Next** and proceed to step 7.

Figure 8-6: Change Current Destination Folder

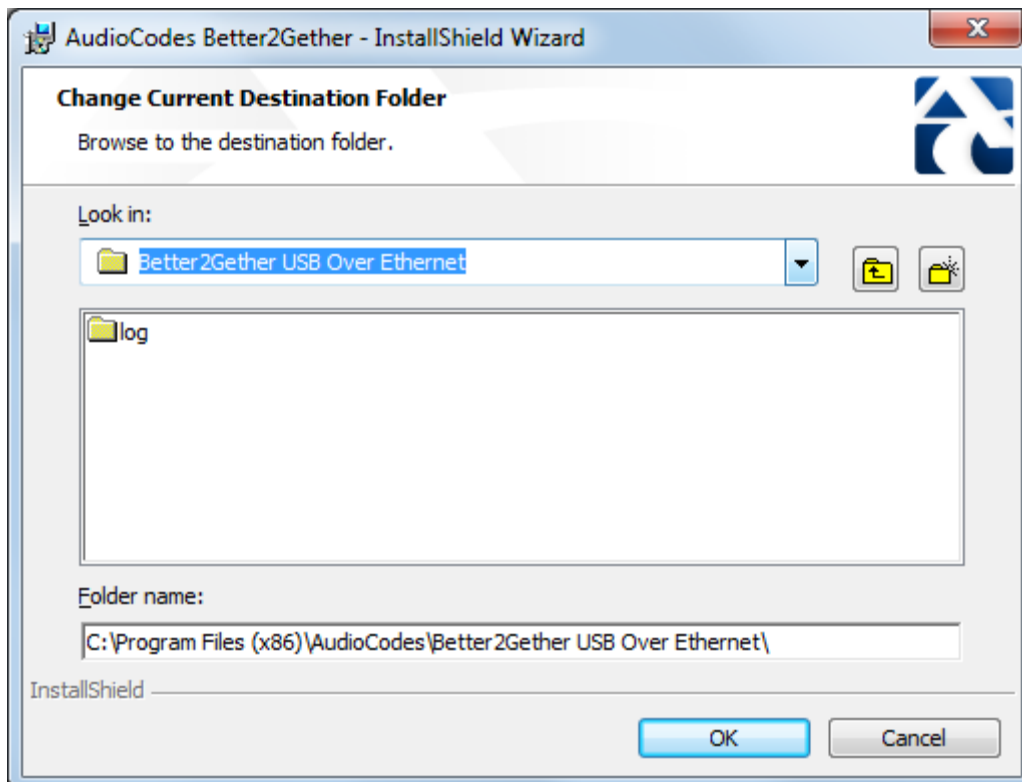

6. Click **OK**; you're returned to the Destination Folder screen.
7. Click **Next**; the Ready to Install screen opens.

Figure 8-7: Ready to Install

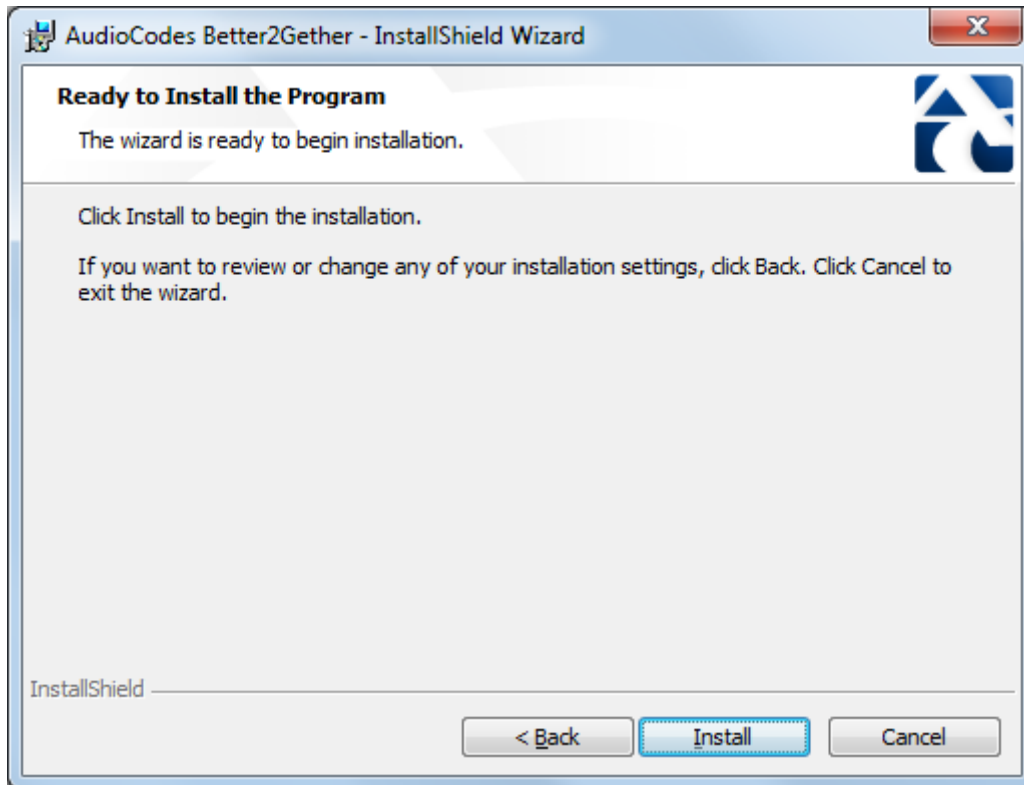

8. Click the **Install** button; the Installing AudioCodes Better2Gether screen opens indicating installation progress status.

Figure 8-8: Installing AudioCodes Better2Gether

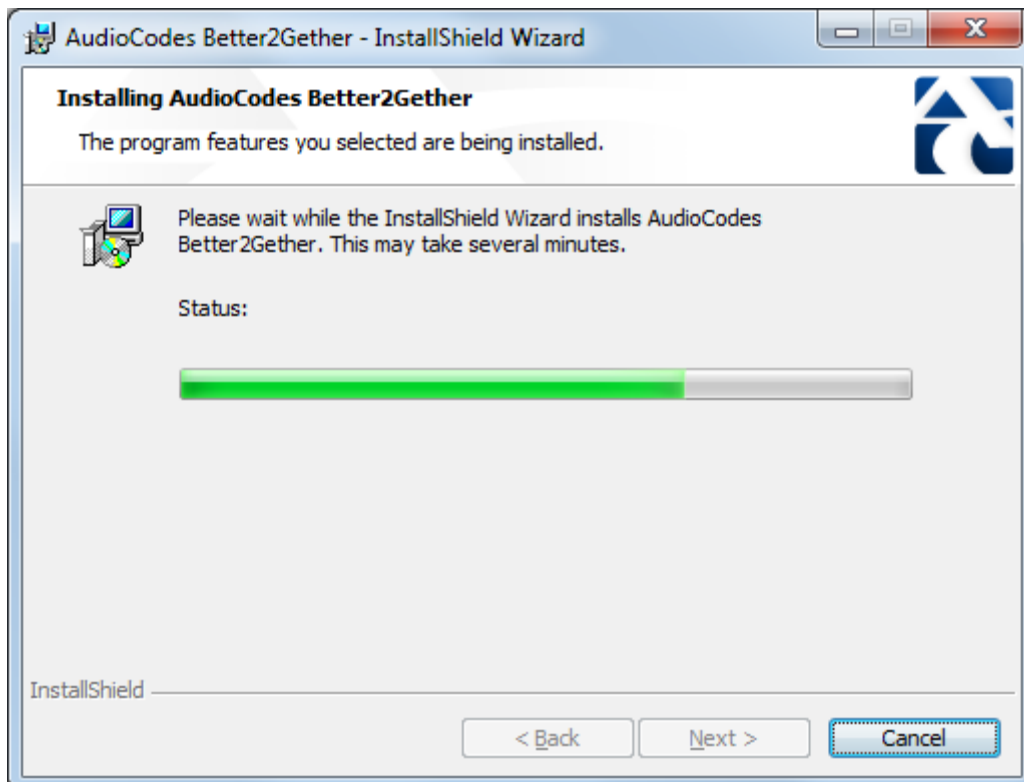

9. Wait until the following screen is displayed:

Figure 8-9: InstallShield Wizard Completed

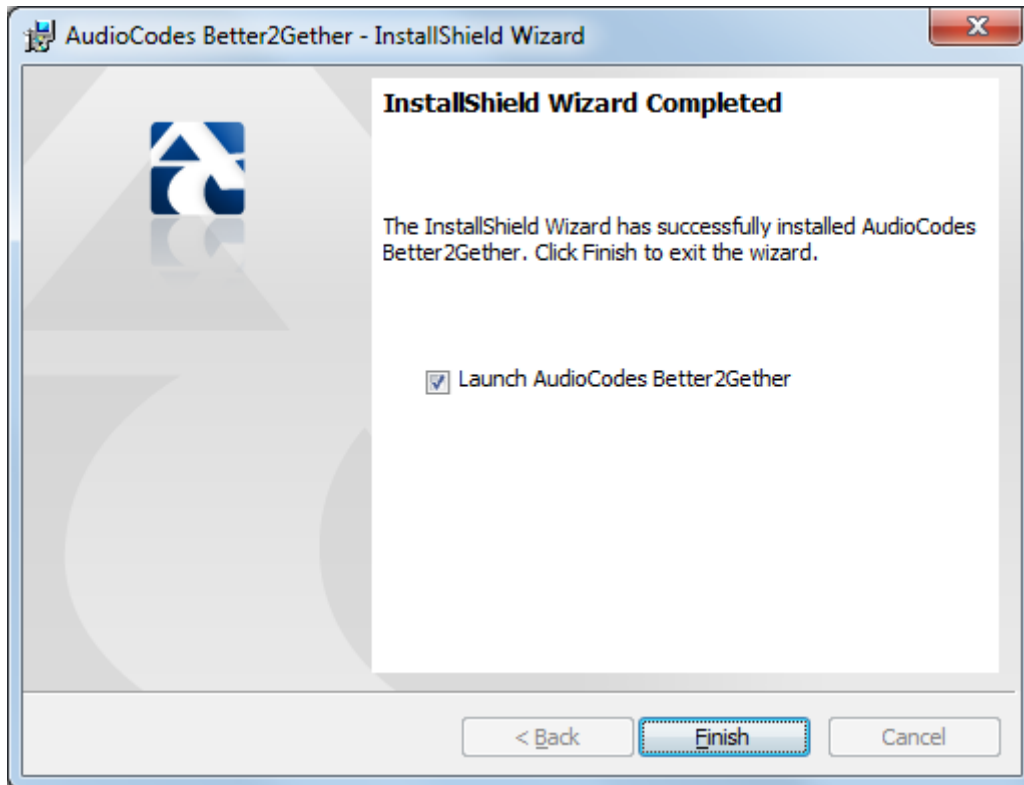

- 10. Click the **Finish** button and then check your Windows taskbar and locate the newly displayed AudioCodes icon (AC) as shown below:

Figure 8-10: AudioCodes Icon in Taskbar

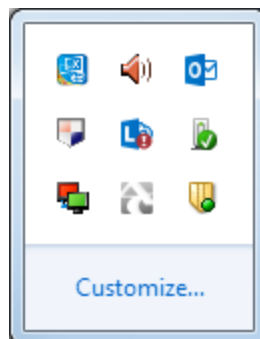

- 11. Wait until the “Installing device driver software” process completes:



- 12. Check your programs in the Control Panel > Programs. You should see:

Figure 8-11: Control Panel>Programs>AudioCodes Better2Gether

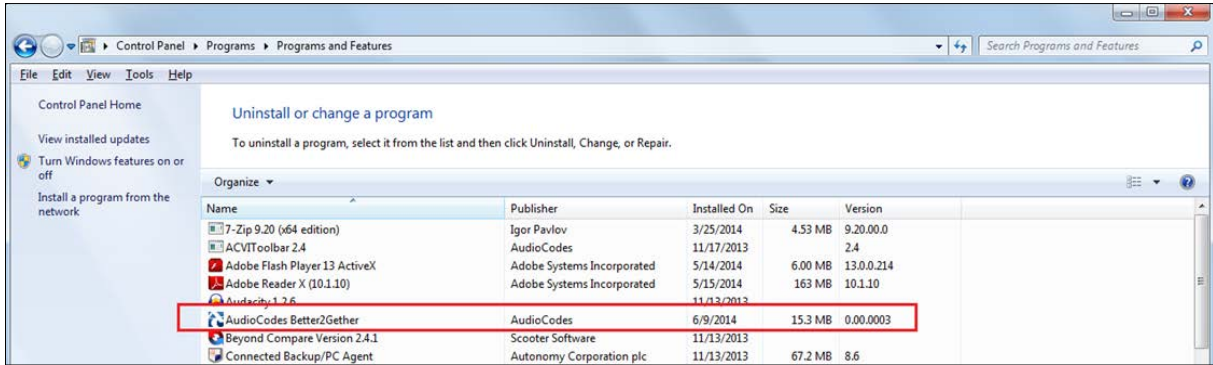

Note: You can use this entry in the Control Panel > Programs to uninstall.

13. Access Computer Management > Services and Applications and locate BToE:

Figure 8-12: Computer Management > Services and Applications

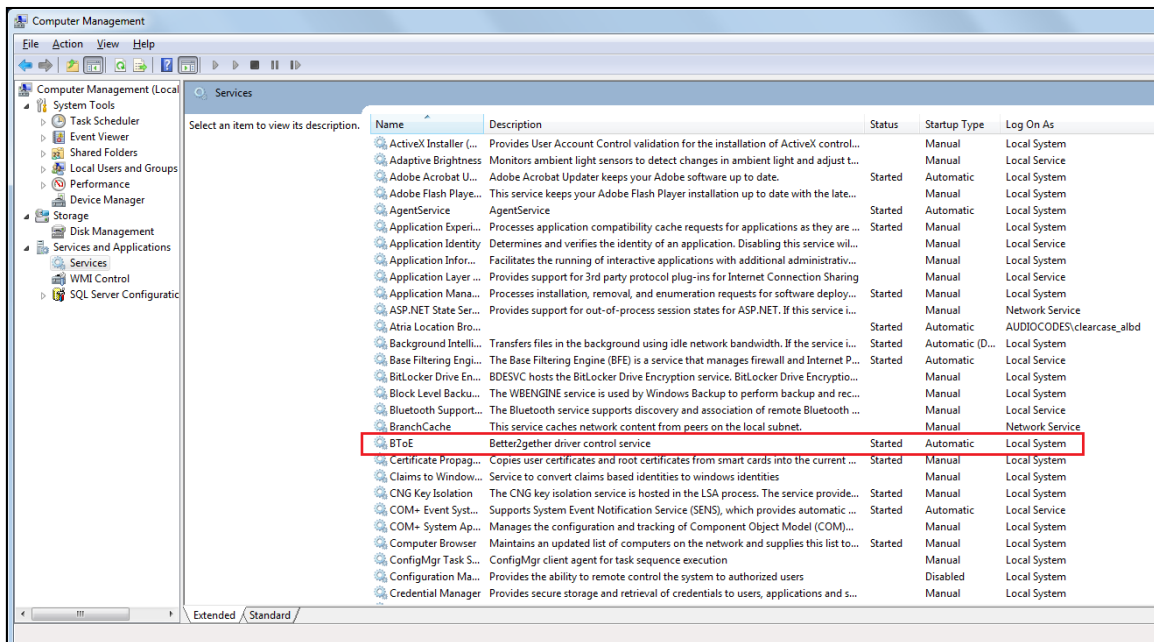

14. Access the Device Manager and locate 'AudioCodes B2GoE USB driver'.

Figure 8-13: Device Manager > AudioCodes B2GoE USB Driver

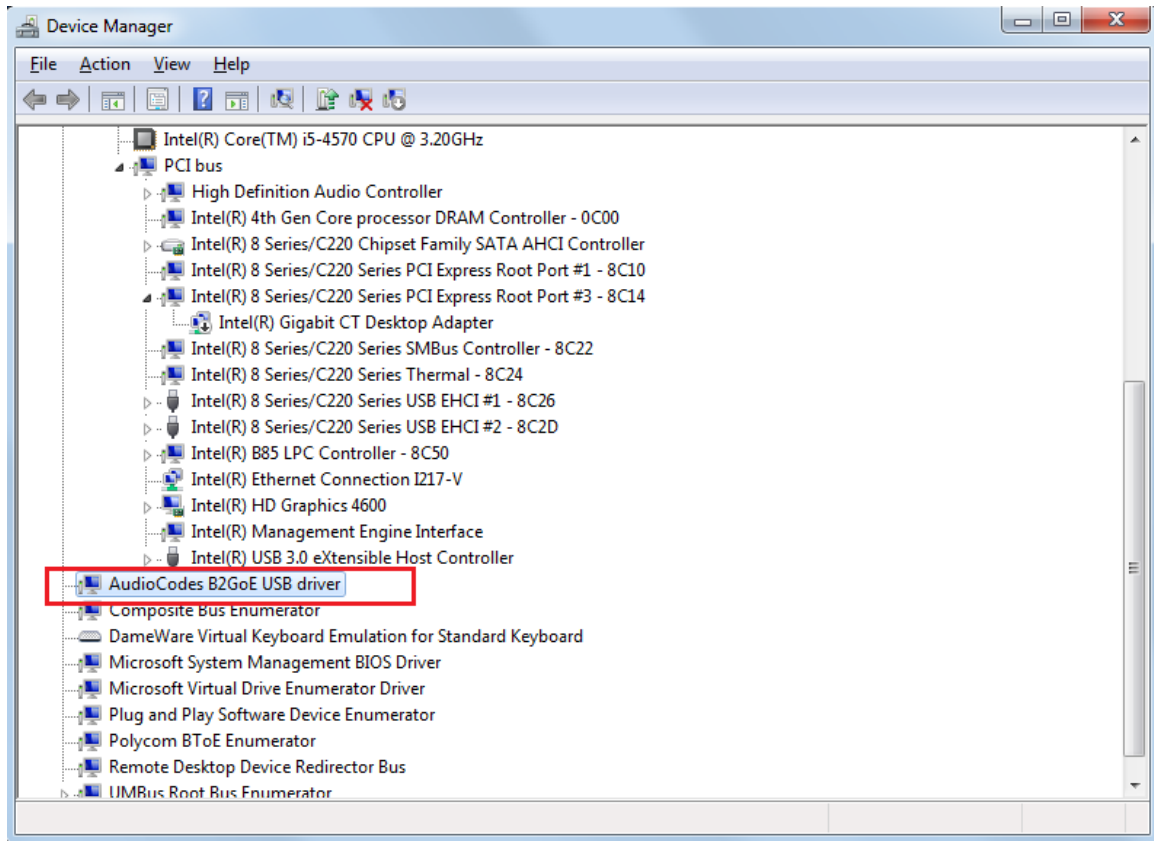

You've successfully installed the program.

8.1.2 Making Sure BToE is Correctly Installed

This section shows how to make sure Better Together over Ethernet is correctly installed.

➤ **To make sure BToE is correctly installed:**

1. Click the **AC** (AudioCodes) taskbar icon; the following menu pops up:

Figure 8-14: Popup Menu

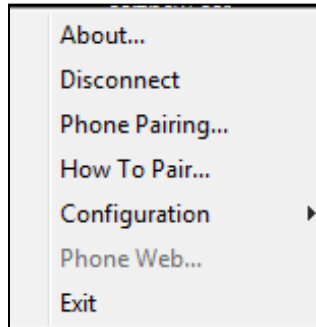

2. Select the **About...** menu option to verify the DLL and BToE version:

Figure 8-15: About AC BToE

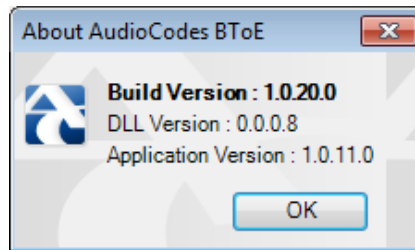

8.1.3 Configuring the BToE TCP Port

You can opt to configure a different BToE TCP port to the default 9999, depending on the requirements of your enterprise. For example, you may decide to change the BToE TCP port to 5000 because your enterprise is using the default port of 9999, and 5000 is available. This feature therefore provides enterprise administrators with more freedom in network administration.



Note: If you decide to change the default BToE TCP port, you must update *both* the PC/laptop *and* the IP phone with the new BToE TCP port number.

➤ **To change the BToE TCP port on the PC/laptop side:**

1. Click the **AC** (AudioCodes) taskbar icon; the menu shown in [Figure 8-14](#) pops up.
2. Select **Disconnect** in the popup menu and then select **Configuration > TCP Port**.

Figure 8-16: TCP Port

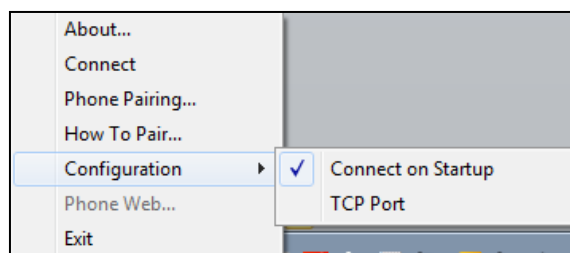

- From the AC BTOE TCP Port dialog that opens, configure the TCP Port:

Figure 8-17: AC BToE TCP Port



The valid range is 1 to 65535.

- **To change the BToE TCP port on the IP phone side:**
 - See the *Administrator's Manual*.

8.1.4 Enabling BToE for Online Users



Note: To enable BToE for online users, the Skype for Business server must be configured to enable BToE.

8.1.5 Automatically Pairing the BToE PC/Laptop Application with the IP Phone

Pairing is automatically performed when the phone's PC port is connected to the PC/laptop 'behind' the phone. See the *Administrator's Manual* for more information.



Note: Automatic pairing requires BToE PC/laptop application Version 2.x.

If the laptop after *automatic* pairing is disconnected and moved to another location, its speaker/headset becomes the audio device associated with the Skype for Business client.

If the laptop is *manually* paired and then relocated, Skype for Business audio will remain through the phone. It's therefore advisable to pair *automatically*.

Note: If the BToE PC/laptop application has already been *manually* paired with the phone, as shown in the section below, and you want to *automatically* pair, you must delete the old pair code from the BToE PC/laptop application in order to allow BToE *automatic* pairing:

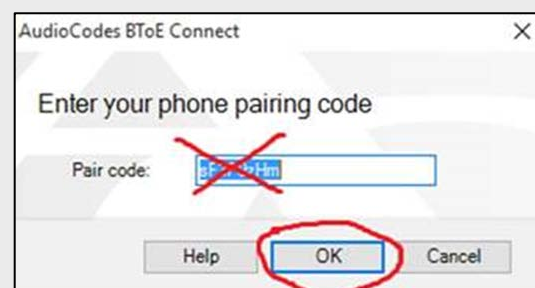

8.1.6 Manually Pairing the BToE PC/Laptop Application with the IP Phone

This section shows how to *manually* pair AudioCodes' BToE PC/laptop application with the IP phone using a pair code. Even though *automatic* pairing gives users greater freedom, *manual* pairing is still an option. Manually pair like this:

1. Generate a pair code (see Section 8.1.6.1)
2. Connect the IP phone and BToE PC/laptop application using the pair code (see Section 8.1.6.2)



Note:

- If the IP changes, you will need to generate a pair code again.
- If you know the last pair code, you don't need to generate a new one. If you don't know it, continue below.

8.1.6.1 Manually Generating a Pair Code

This section shows how to manually generate a pair code.



Note: The phone is by default *automatically paired* with the PC/laptop. If you want to *manually* pair, consult with your network administrator. See the *Administrator's Manual*.

➤ **To manually generate a pair code:**

1. Press the MENU hard key on the phone.

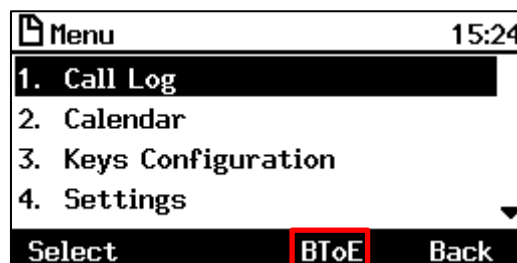

2. Press the **BToE** softkey; the BToE pair code is displayed:

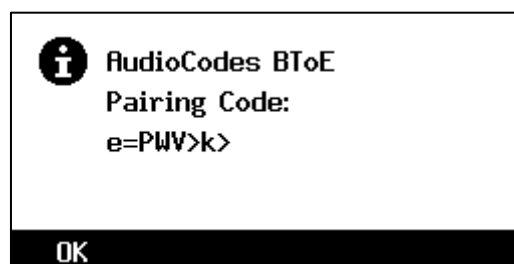

This is the pair code that will be used by the BToE PC/laptop application. Make a note of it for reference when connecting the IP phone with the BToE PC/laptop application.

8.1.6.2 Manually Connecting the IP Phone with the BToE PC/Laptop Application

This section shows how to connect the IP phone with the BToE PC/laptop application.

➤ **To connect the two:**

1. Open the AudioCodes BToE Connect screen: Click the BToE client icon placed on your taskbar after installation; the following popup menu opens.

Figure 8-18: Popup Menu

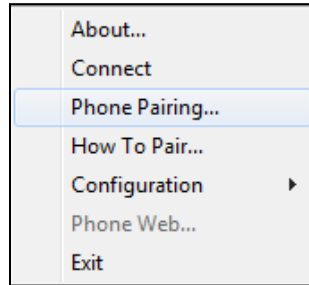

2. Select the **Phone Pairing** option

Figure 8-19: Phone Pairing

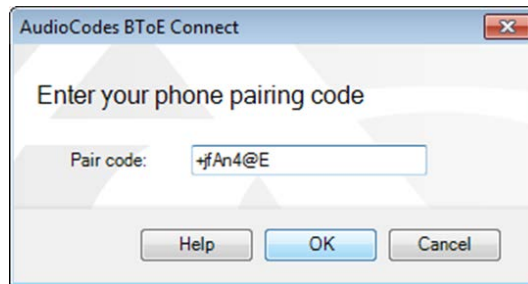

3. In the 'Type the pair code' screen, enter the pair code that you generated as shown in Section 8.1.6.1; the **OK** button is activated after 8 characters are entered.
3. Click the **OK** button; BToE is activated.
4. If a communication error occurs or the wrong pair code was entered, the following icon indication appears:

Figure 8-20: AC BToE Failed Indication

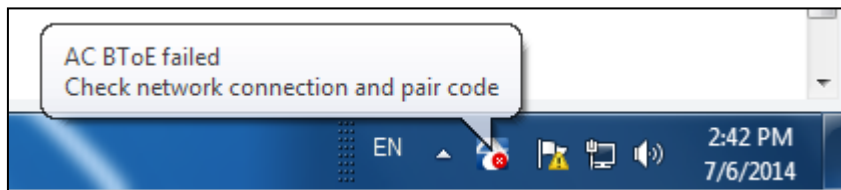

5. When BToE is successfully connected, view the following icon indication:

Figure 8-21: AC BToE is Connected Indication

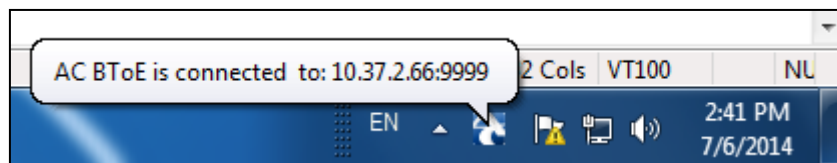

6. When BToE is in 'Connected' state, the popup menu shows the **Disconnect** menu item and the **Phone Pairing** menu item is deactivated:

Figure 8-22: Popup Menu: 'Disconnect' Enabled, 'Phone Pairing' Disabled

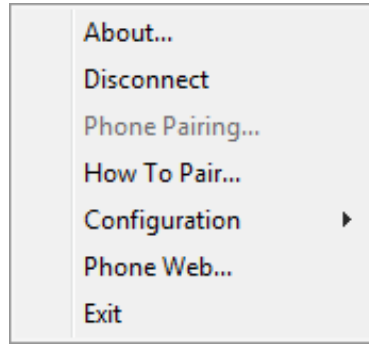

7. After selecting the **Disconnect** menu option, the 'AC BToE Disconnected' indication is displayed:

Figure 8-23: BToE Disconnected

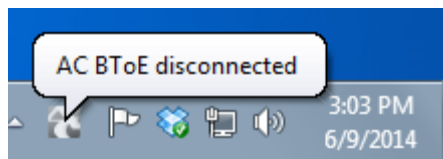

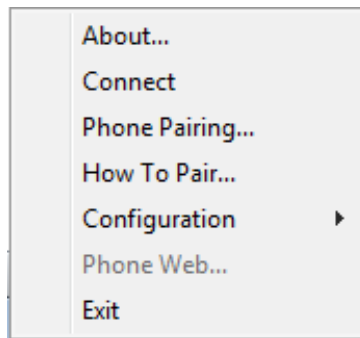

8. From the popup menu as well you can see if BToE is disconnected:

Figure 8-24: Popup Menu: BToE Disconnected



Note: When BToE is connected, you can select the **Phone Web** menu option to open the phone's the Web interface.

9. Use the table below as reference when determining BToE's connection state from the taskbar icon.

Taskbar Icon	BToE's connection state
	BToE is connected
	BToE is disconnected
	BToE is connected but a failure is preventing a correct connection. The failure can be a network problem or the wrong pair code was defined.

10. From the click popup menu, you can select the **Exit** option; the BToE PC application stops. You can activate the application again from the Start menu as shown in [Figure 8-25](#).

Figure 8-25: Start > Programs > AudioCodes > BToE Controller

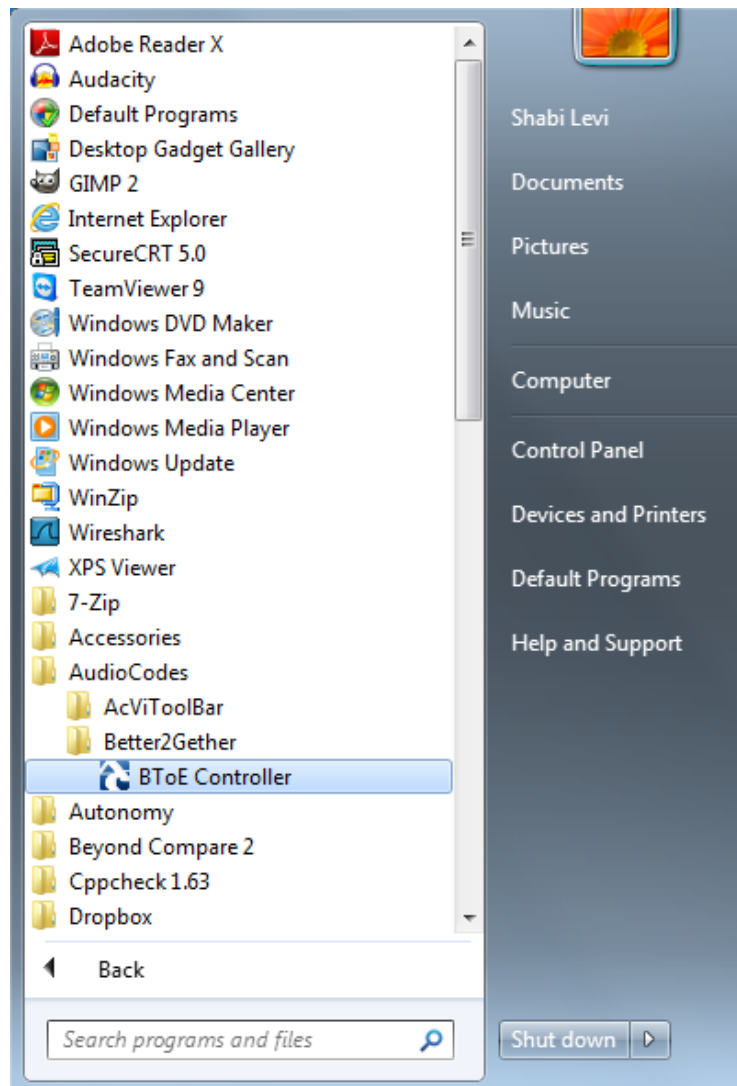

8.1.6.3 Connecting the Skype for Business Client with the IP Phone

This section shows how to connect the Microsoft Skype for Business client with the IP phone using the Skype for Business login screen.

➤ **To connect the two:**

- Enter your credentials in the Skype for Business Sign-in request prompt, and click **OK**.

Figure 8-26: Skype for Business Sign-in Request Prompt

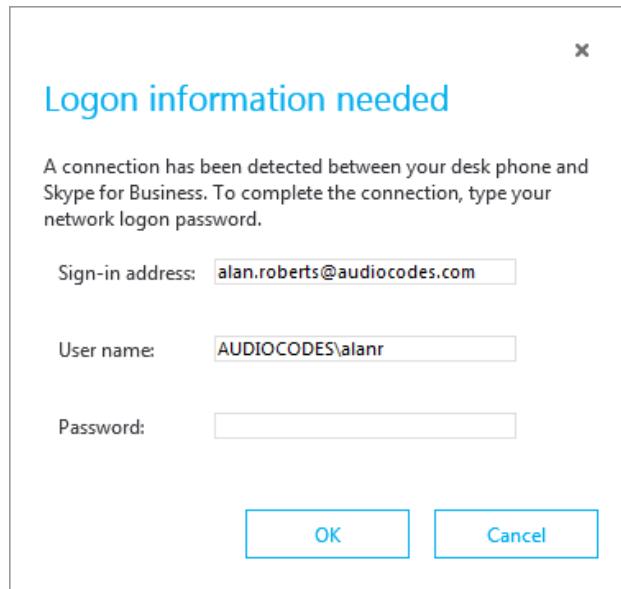

Note: Primary Device cannot be changed in Skype for Business Client PC/laptop client during a call. When the phone is in idle mode (not in a call), the PC/laptop application must be disconnected in order to change Primary Device. See the *Release Notes*.

8.1.7 Making Sure IP Phone/ Skype for Business Client are Paired

This section shows how to make sure you successfully paired your IP phone with the Skype for Business client.

8.1.7.1 Making Sure Skype for Business Client is Paired

You can make sure the Skype for Business client is paired with the IP phone.

➤ **To make sure the Skype for Business client is paired with the IP phone:**

1. In the Skype for Business client application, in the lowermost left corner of the screen, click the Select Primary Device icon ; the following popup menu opens:

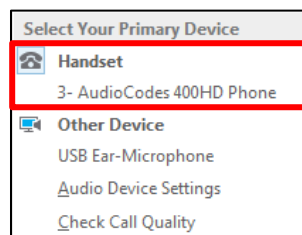

2. Make sure **Handset AudioCodes 400HD Phone** is selected.

8.1.7.2 Making Sure the IP Phone is Paired

You can determine from the IP phone's idle screen if the phone is paired with the Skype for Business client. Two interlocked rings in the idle screen indicate the phone is paired.

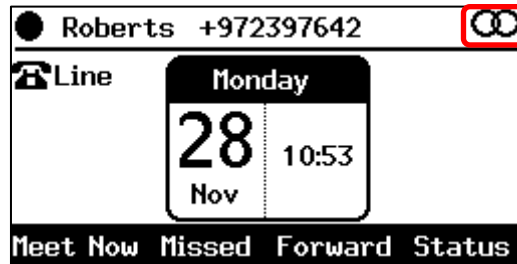

If the idle screen does not display two interlocked rings, the phone is *not* paired.

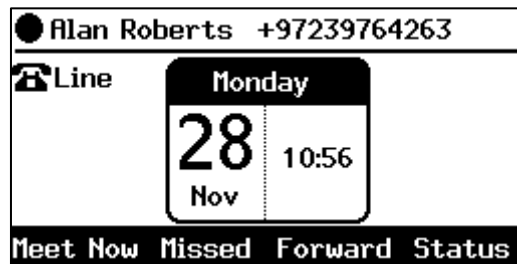

After connecting, a 'BToE Activated' notification pops up and then disappears. The two interlocked rings remain.



8.2 Using BToE Functions

This section shows how to use your IP phone as an extension of your Skype for Business client, and how to use your client as an extension of your IP phone, for enhanced unified communications and optimized efficiency.

Before using BToE functions, you need to install BToE. See the *Administrator's Manual* for detailed information on installing BToE. Before using BToE functions, make sure in the Skype for Business client that the 'Primary Device' selected is **Handset AudioCodes BToE**.

8.2.1 Signing in to the Phone from the Skype for Business Client

You can sign in to the IP phone from the Skype for Business client.

➤ **To sign in to the phone from the Skype for Business PC client:**

1. Sign out from the IP phone.
 - a. In the phone's idle screen, press the **Status** softkey:

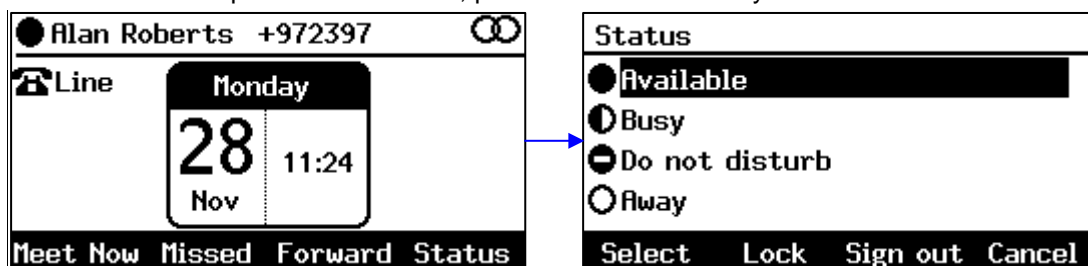

- b. In the Status screen, press the **Sign out** softkey; the phone goes offline.



- c. The Skype for Business client on the PC prompts you for Logon information.

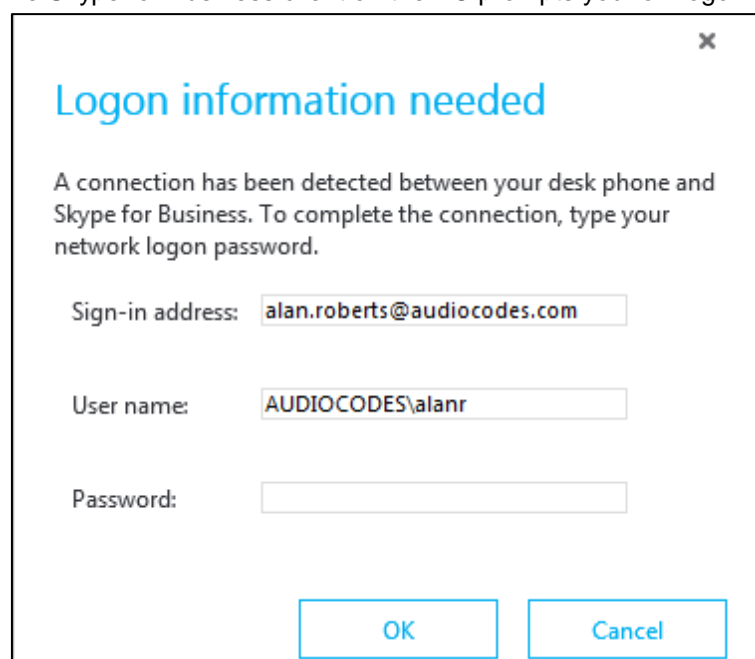

- In the Skype for Business client Logon information prompt, enter the same password you use to access your PC and then click **OK**; the phone's screen displays the registration process, a 'BToE Activated' notification pops up, and the Phone Lock screen is displayed.
- Enter a PIN code to unlock the phone – see Section 5 for more information.

The phone is signed in and after a few seconds, the two interlocked rings are displayed indicating that the phone is paired with the PC BToE application.

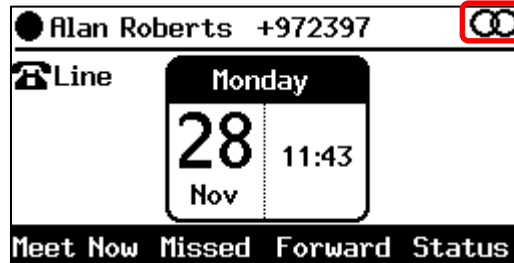

Note that the phone's IP address may change during the registration process.

8.2.2 Making a Call (Click-to-Dial)

You can make a call from the PC Skype for Business client or from the IP phone; in both cases, the one operation mirrors the other, providing an enhanced unified communications experience and optimizing enterprise efficiency.

➤ To make a call:

- In the PC Skype for Business client, click the digit keys of the person's number to call. Alternatively, you can call them from Outlook; the IP phone's user interface displays the **CALLING** screen (shown below) while the PC Skype for Business client simultaneously displays the conversation screen.



- When the called party answers, you can use either your phone or PC Skype for Business client to talk, whichever is more convenient. When BToE is paired, you can use only the phone to talk; the client is used to control the call. To talk via the client, you must switch the primary device. You can use the phone's speakerphone, handset or headphones.

8.2.3 Answering a Call

You can answer an incoming call on the Skype for Business client or IP phone, whichever is more convenient for you at the time, providing an enhanced unified communications experience and optimizing enterprise efficiency. When answering an incoming *video call* with a paired phone, the call is established. The default device is the PC speaker/microphone rather than the phone. Subsequent audio calls will be unaffected; the paired phone will still be the default device.

➤ **To answer a call on the IP phone:**

1. When the INCOMING CALL screen is displayed in the IP phone's user interface, press the **Accept** softkey; the call is answered.

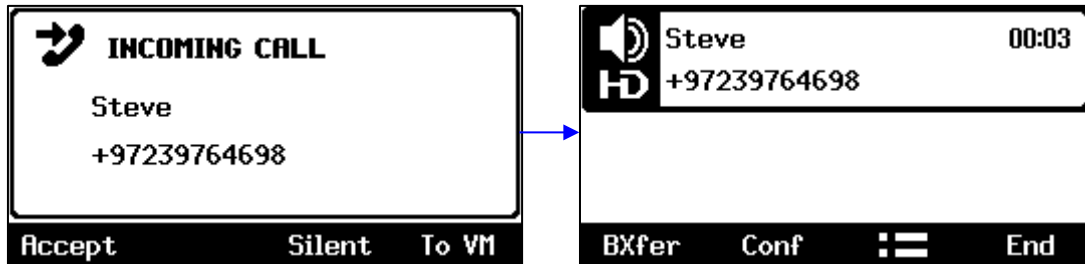

2. You can end the call by pressing the **End** softkey.

8.2.4 Establishing a Unified Communications Call Conference

The phone supports multi-party Skype for Business remote conferencing. BToE is not mandatory for conferencing - see Section 8.9 for more information about conferencing. BToE *is* mandatory for *unified communications conferencing*. When BToE is installed, the phone's screen mirrors the PC Skype for Business client; conferencing in the phone's screen then reflects conferencing in the PC Skype for Business client.

The example below shows how BToE integrates phones with PC Skype for Business clients for unified communications call conferencing.

- In the PC Skype for Business client, Alan calls Steve.

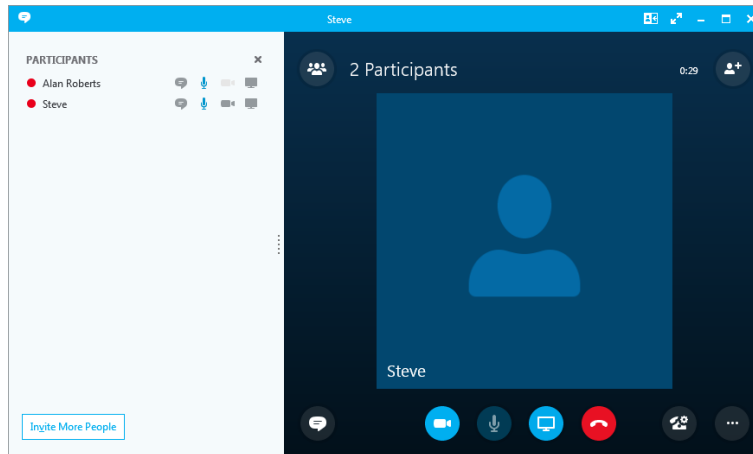

- Steve answers his phone.

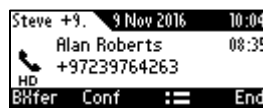

[The screen of another phone model is shown here for illustrative purposes]

- In his client, Alan clicks **Invite More People** and dials Hilary, who answers.

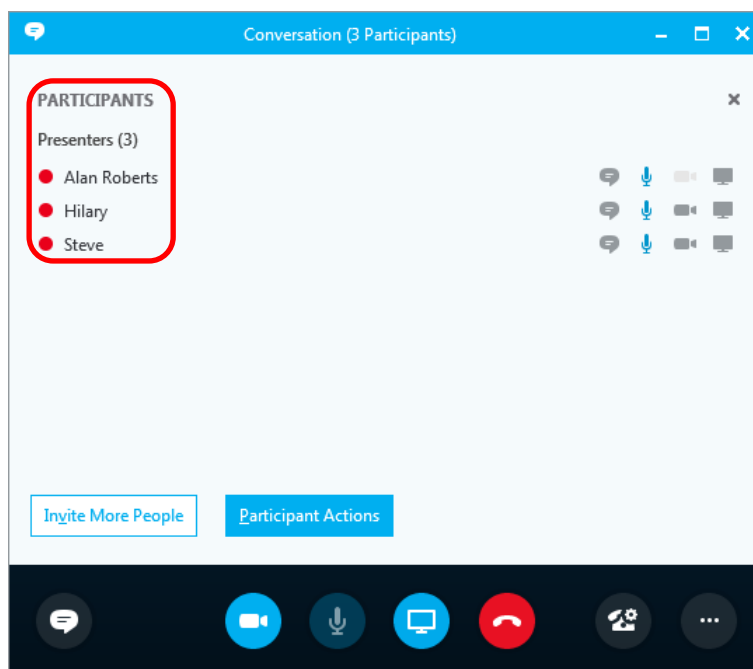

- Hilary sees the call is a conference call initiated by Alan and that Steve has been invited:

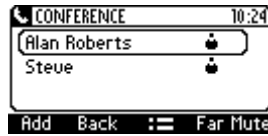

[The screen of another phone model is shown here for illustrative purposes].



Note:

- After making a call in the client, you can invite an unlimited number of other participants.
- You can use the phone's speakerphone, handset or headphones to continue the meeting.
- When a user whose phone is connected to BToE joins a meeting, their phone is muted and the red **MUTE** button is lit. The user can unmute using the phone's **MUTE** button.
- You can press the phone's **End** softkey to end a meeting.

See Section 8.9 for more information about conferencing.

8.2.5 Transferring a Call

You can transfer a call to another party either from your PC Skype for Business client or IP phone, whichever is more convenient for you at the time, for an enhanced unified communications experience.

➤ **To transfer a call:**

1. From your PC Skype for Business client or IP phone, whichever is more convenient, make a call; calling is indicated on both the PC Skype for Business client and the IP phone.
2. When the called party answers, you can perform a blind transfer or a consultation transfer, using your phone or your PC Skype for Business client, whichever you prefer.
 - For detailed information on performing call transfer with the phone, see Section 8.6.
 - For details on performing call transfer with the PC Skype for Business client, see Microsoft documentation. A guideline is shown below. The operation is mirrored in your phone. Note that a paired Skype for Business client can't perform consultation transfer.

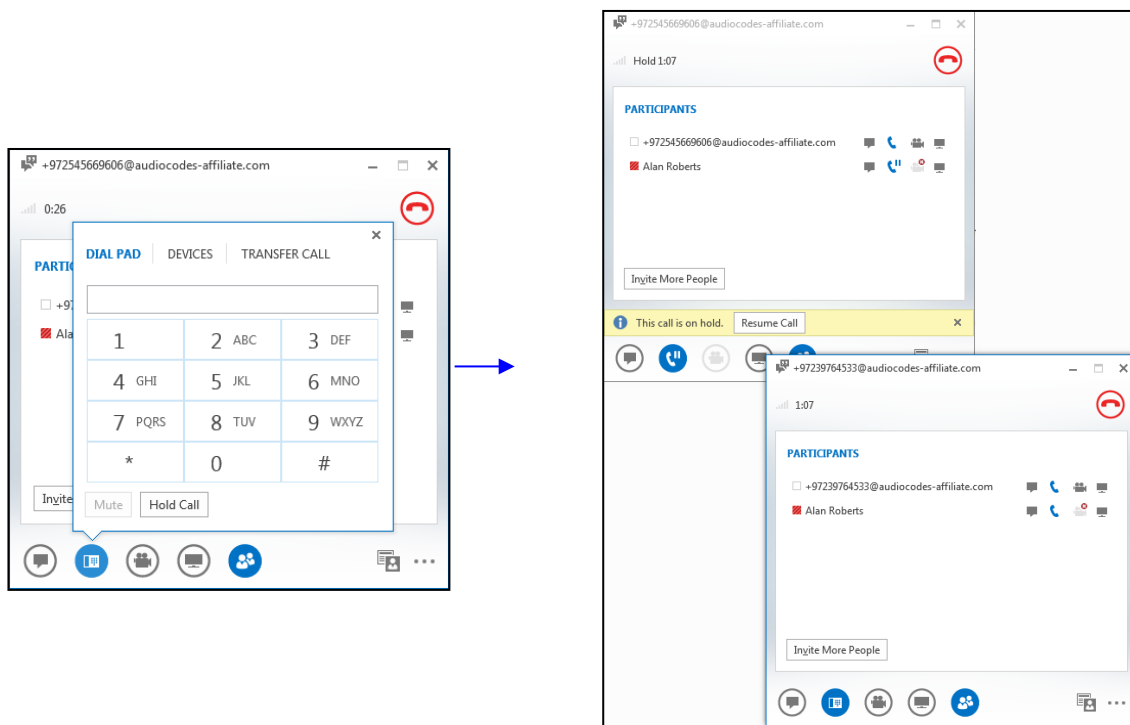

8.2.6 Switching the Primary Audio Device

BTtoE lets you switch primary audio device, so you can switch from listening to a Skype for Business conversation through the phone handset, for example, to listening on a headset, or from listening on a headset to listening through the IP phone speaker.

➤ **To determine which audio device is currently primary:**

- Locate in the lowermost left corner of the Skype for Business client screen the icon indicating 'Primary Device'.

Figure 8-27: Primary Device: IP Phone



Figure 8-28: Primary Device: Headset

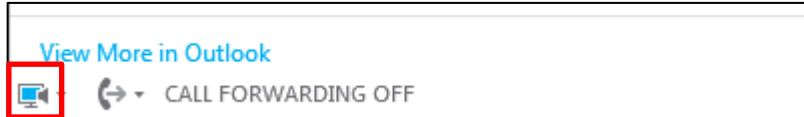
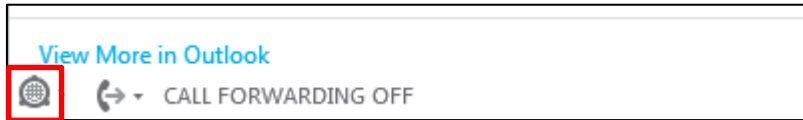
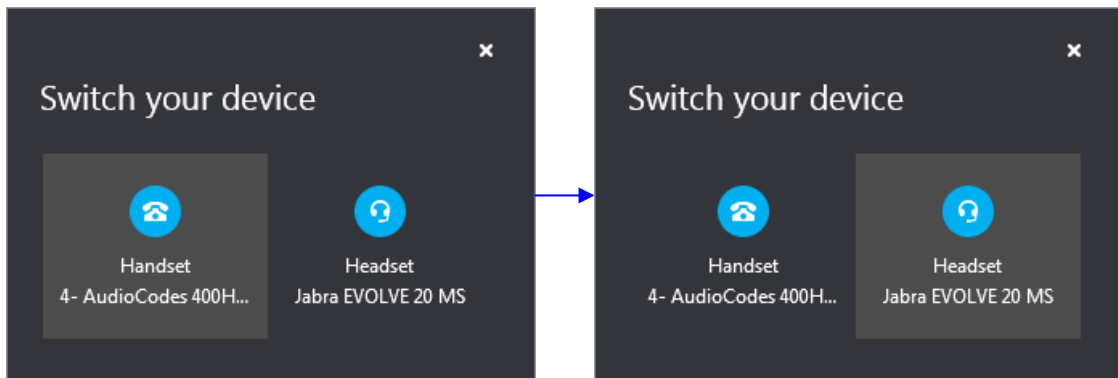
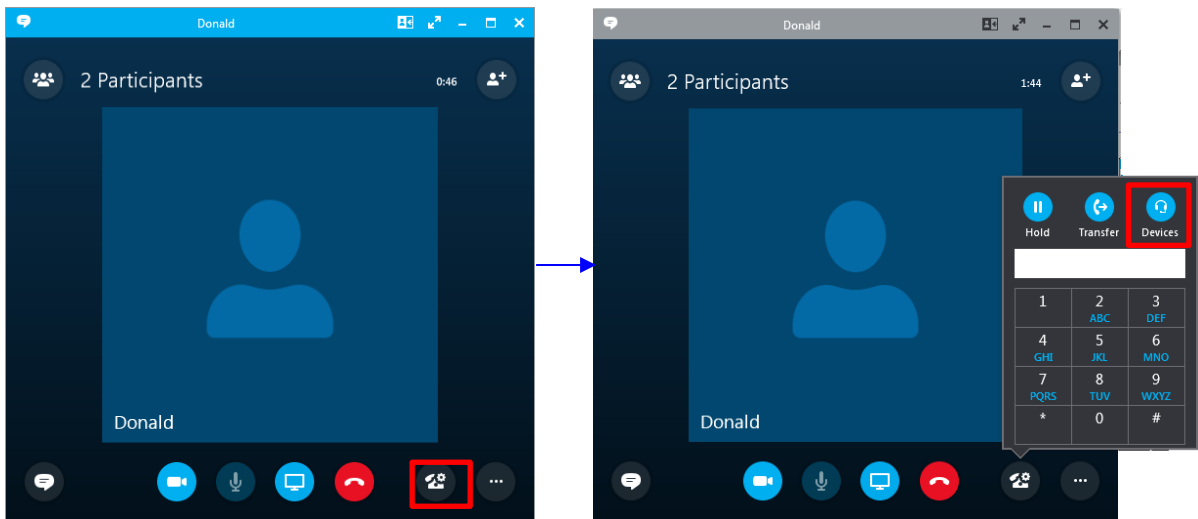

Figure 8-29: Primary Device: Speaker



➤ **To switch primary device:**

- In a Skype for Business call, click the **Call Control** icon and select **Devices**.



8.2.7 Routing Voice from a Video Call to the Phone

When a video call comes in, video is displayed in the PC/laptop based Skype for Business client. The user can route the voice from the video call to the phone. In this scenario, the phone performs similarly to a USB device.

The example below illustrates how Ami Lahav, who's in a video call with Yaron Moshkovitz, routes voice to the phone.

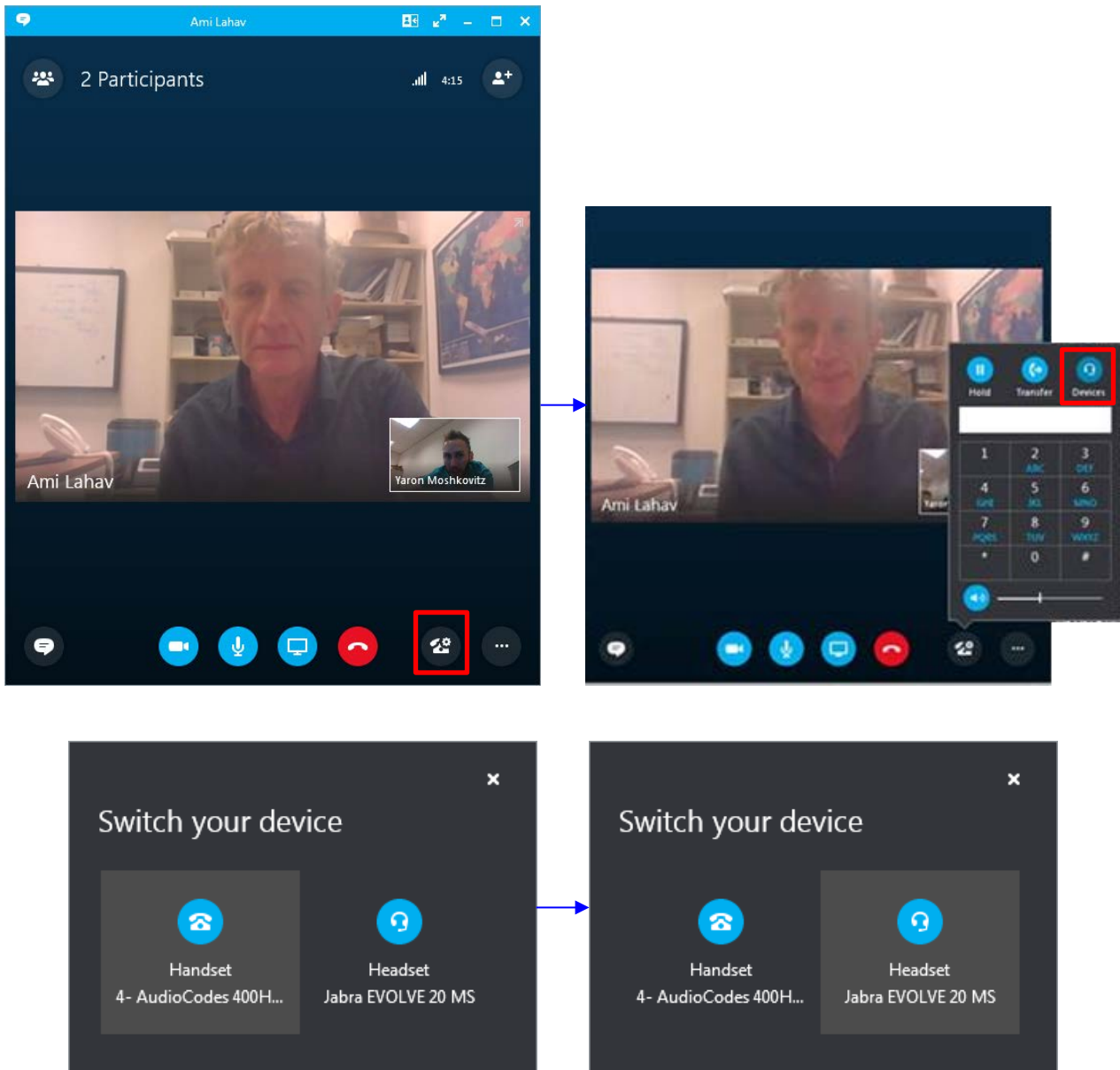

8.3 Using the Boss Admin Feature

This section shows how to use the Boss Admin feature. The feature allows a relationship to be established between a boss's phone and an administrative secretary's phone. The feature streamlines office workflow and enhances office efficiency.



Note:

- Each phone can support up to five Bosses or Admins.
- For setup information, see the *Administrator's Manual*.
- To remove an Admin, the Boss must remove the Admin in the 'Call Forwarding – Delegates' screen (open the Skype for Business client > click **Call Forward Settings** > click **Edit my delegate members** > select the Admin > click **Remove**). It's not enough to turn off call forwarding.

8.3.1 Viewing who the Admins are on the Boss' Phone

After configuring an Admin, you can view the Admin on the Boss' phone.

In the Boss's phone's idle screen, the Admin line is indicated by **this** icon:

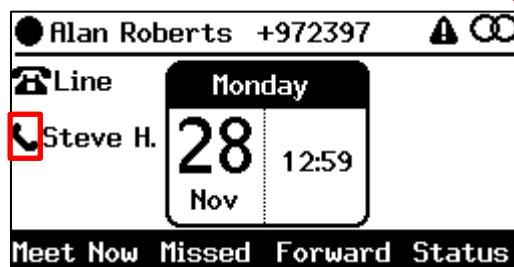

➤ **To alternatively see the Admins on the Boss' phone:**

1. Press the CONTACTS hard key on the phone and then in the Favorites screen that opens, press the **≡** softkey; the Contact groups are displayed:

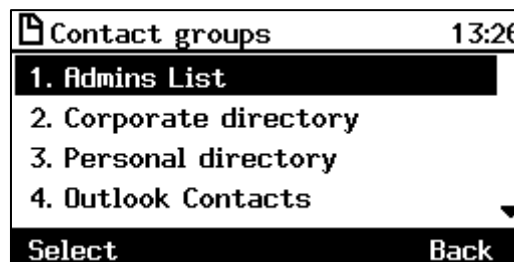

2. Select **Admins List** from the Contact groups.



One Admin is configured: **Steve Hopkins**

8.3.2 Viewing who the Bosses are on the Admin's Phone

You can view on your phone which Boss configured you on their phone as an Admin. This can be useful for an administrative secretary replacing another during a lunch break.

The Boss' line is indicated by **this** icon in the Admin's idle screen:

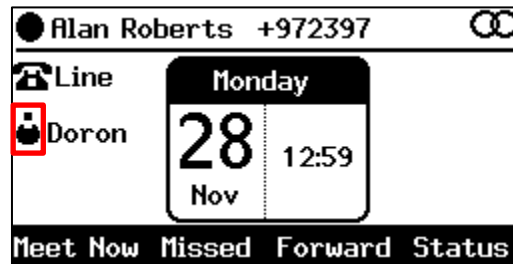

On the phone, you can press the line key of a Boss:

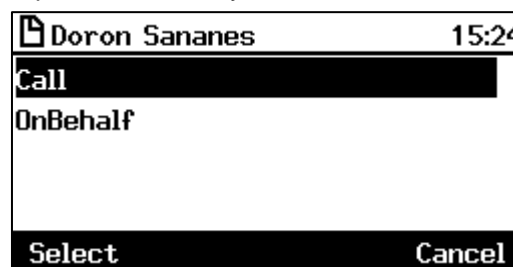

Select **Call** to dial that Boss or **OnBehalf** to dial on behalf of that Boss.

➤ **To alternatively see the Bosses on an Admin's phone:**

1. Press the CONTACTS hard key on the phone and then in the Favorites screen that opens, press the **≡** softkey; the Contact groups are displayed.

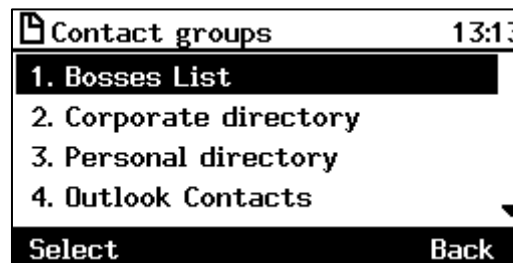

2. Select **Bosses List** from the Contact groups.

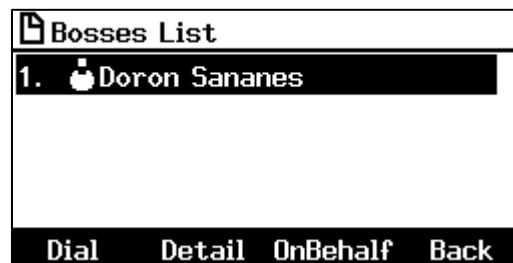

One Boss is configured, as you can see: **Doron Sananes**

3. From the list, you can select a Boss and press the **Dial** softkey to dial them, or press the **OnBehalf** softkey to dial a destination number on their behalf.

8.3.3 Viewing Bosses and Admins

You can *be* a Boss and you can *have* a Boss. You can be an Admin in charge of the other Admins in the office, i.e., you can be their Boss, but you can also report to a Boss above you. You can, therefore, have two lists displayed in your IP phone: Bosses *and* Admins. To view them, access the 'Contacts groups' screen as shown in the previous section.

8.3.4 Handling an Incoming Call for the Boss

Admin can handle an incoming call for the Boss.

➤ **To handle an incoming call for the Boss:**

1. If a call (from **Hilary** for example) comes in on the phone of the Boss (**Mike Dubb**), the phone of the Admin (**Alan Roberts**, shown below) rings simultaneously:

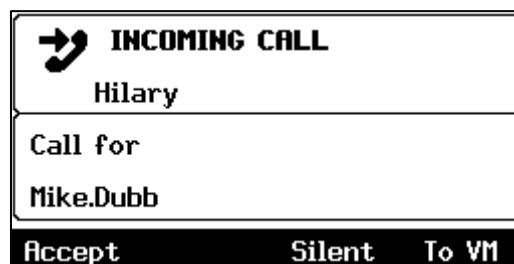

2. Admin can press the **Accept** softkey or lift the handset to take the call. On the Boss' phone, a notification is displayed indicating the call was answered by Admin.

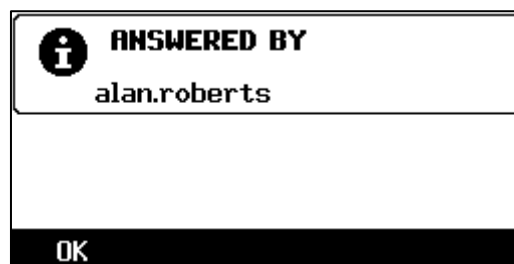

3. Admin can press the **☰** softkey and from the Call Menu screen that opens, select the **Handoff** option; the call is transferred to the Boss.

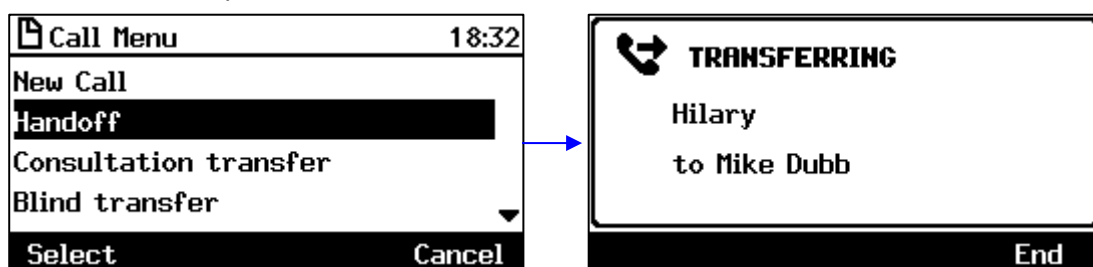

4. When the Boss answers, a notification is displayed on Admin's phone indicating the the call was answered by Boss (similar to the notification displayed on Boss' phone when a call is answered by Admin).

8.3.5 Calling on Behalf of the Boss

Admin can make a call on behalf of Boss by

- pressing Boss' line key (see Section 8.3.5.1)
- keying the digits of the destination number (see Section 8.3.5.2)
- pressing the CONTACTS key on the phone (see Section 8.3.5.3)

8.3.5.1 Using Boss' Line Key

Admin can call on behalf of Boss by pressing Boss' line key in Admin's phone's idle screen.

➤ **To make a call on behalf of Boss using Boss' line key:**

1. In the idle screen of the Admin's phone, press the line key of the Boss (**Mike Dubb**, in the example below).

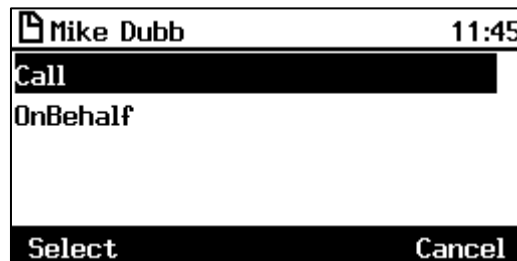

2. Scroll down and select **Call on behalf**.

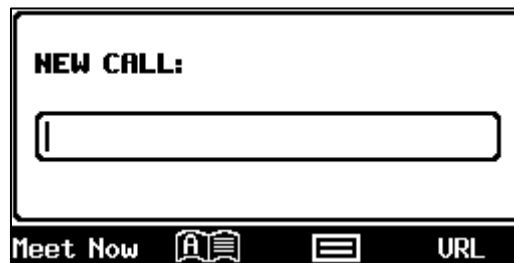

3. Enter the number of the destination to call (**Hilary**, in the example below) and press the enabled **Dial** softkey; the number is dialed; Hilary's end rings.

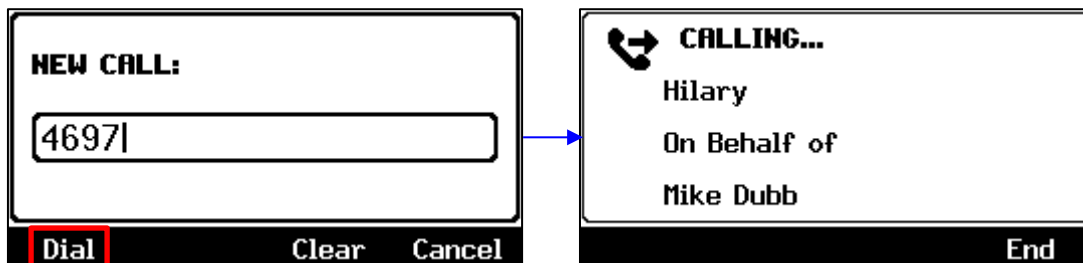

4. Hilary views an incoming call from Admin (**Alan**) on behalf of Boss (**Mike**).

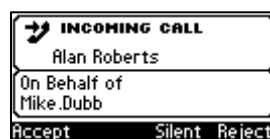

[The screen of another phone model is shown here for illustrative purposes].

5. Hilary answers; Hilary's phone displays this screen:



[The screen of another phone model is is shown here for illustrative purposes].

8.3.5.2 Keying in the Destination Phone Number

You can make a call on behalf of Boss by pressing the digit keys of the destination phone number.

➤ **To make a call on behalf of Boss:**

1. On the phone's dial pad, press the first digit key of the destination number; the NEW CALL screen opens displaying the **OnBehalf** softkey:

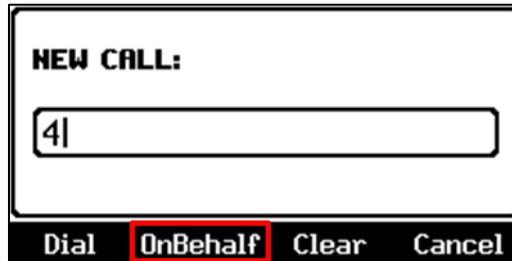

2. Enter the rest of the destination number and then press the **OnBehalf** softkey; the Bosses List screen opens:

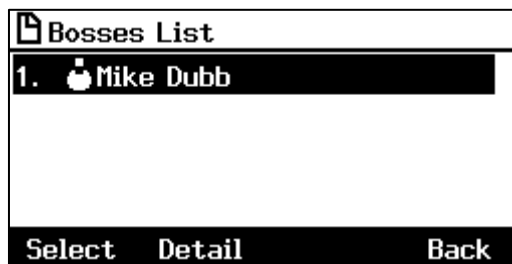

3. Navigate to the Boss on behalf of whom to call (the screen above shows only one configured Boss, **Mike Dubb**, as an example), and then press the **Select** softkey; the phone of the called party phone shows an INCOMING CALL on behalf of **Mike Dubb** (the Boss).

8.3.5.3 Pressing the CONTACTS Key

You can make a call on behalf of Boss by pressing the CONTACTS key on the phone.

➤ **To call on behalf of Boss by pressing the CONTACTS key:**

1. Press the CONTACTS hard key on the phone and then in the Favorites screen that opens, press the  softkey; the Contact groups are displayed:

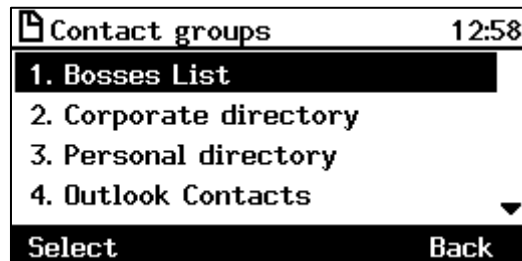

2. Select the **Bosses List** option.

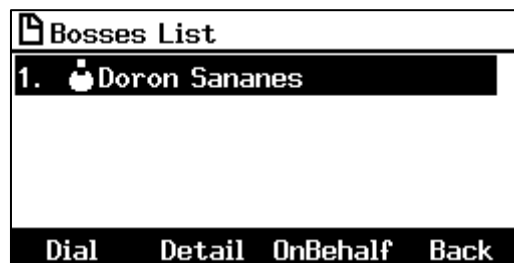

3. Select the Boss on whose behalf you want to make the call.
4. Press the **OnBehalf** softkey and then dial the required number.

8.3.6 Answering a Call on Boss' Phone

When a call comes in for Boss, Boss' phone and Admin's phone ring simultaneously. Boss can answer the call independently of Admin.

➤ **To answer a call on Boss' phone:**

1. When Boss' phone rings, Boss views INCOMING CALL (from Steve, in the example below). Also indicated is that the phones of Boss' Admins (delegates) are also ringing.

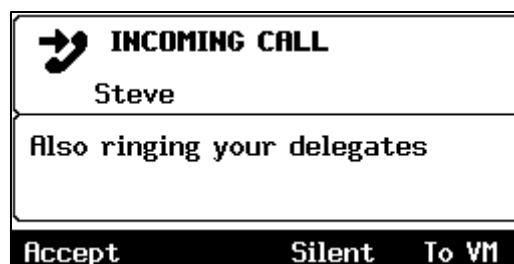

2. If Boss answers the call, a notification is displayed on Admin's phone indicating the call was answered by Boss.

8.3.7 Redirecting an Established Call to Boss' Voicemail

Admin can redirect an established call to Boss' voicemail.

➤ **To redirect an established call to Boss' voicemail:**

1. Admin's phone rings at the same time as Boss' phone when a call for Boss comes in.

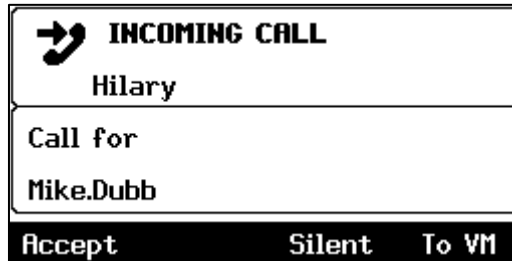

2. Admin presses the **Accept** softkey or lifts the receiver to establish the call.
3. Admin presses the **☰** softkey; the Call Menu is displayed:

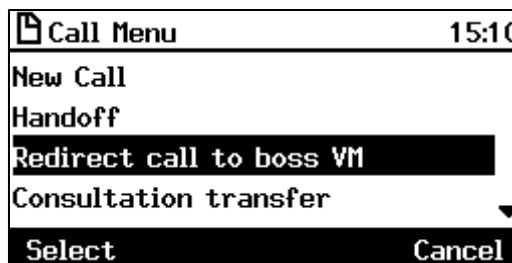

4. Admin selects **Redirect call to boss VM**; the call is forwarded to Boss' voicemail.

8.3.8 Redirecting an Incoming Call to Boss' Voicemail

Admin can redirect an incoming call to Boss' voicemail without answering it. For this feature to be supported, Microsoft Exchange Unified Messaging - including voicemail - must be activated on Boss' account.

➤ **To redirect an incoming call to Boss' voicemail:**

1. When a call for Boss (**Ami Lahav** in the example below) comes in, Admin's phone rings at the same time as Boss' phone. Admin's phone displays a **BossVM** softkey when the call comes in.

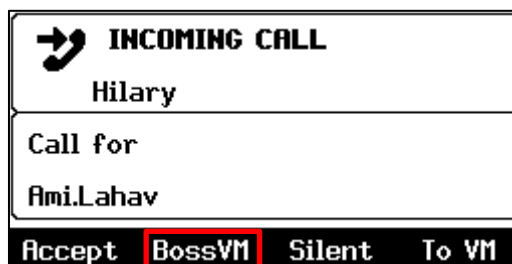

2. Admin presses the **BossVM** softkey before accepting the call; the call is automatically redirected to Boss' voicemail.

8.3.9 Admin Handing Off a Call to Boss

When in a call on Boss' behalf, Admin can hand the call off to Boss. Boss' phone rings and Admin is disconnected. This is similar to Blind Transfer (see Section 8.6.1) except that Boss is always the party to whom the call is transferred.

➤ **To hand off a call to Boss:**

- When in a call on behalf of Boss (with **Hilary**, in the example below), press the **☰** softkey and in the Call Menu, scroll to and select the **Handoff** option; the call with Hilary is handed off to Boss (**Ami Lavi**)

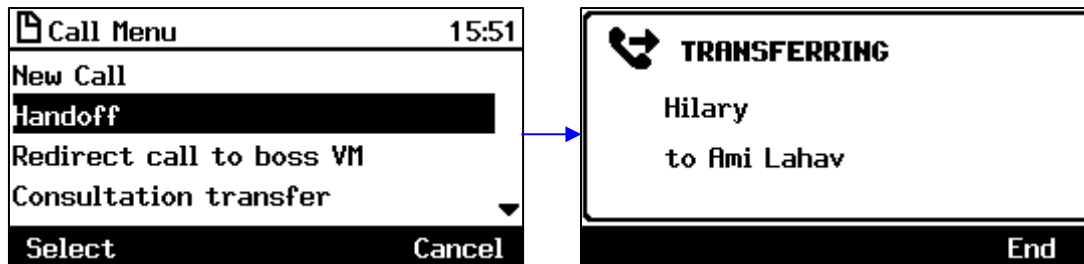

8.3.10 Boss Handing Off a Call to Admin

When in a call, Boss can hand off the call to Admin. This is similar to Blind Transfer (see Section 8.6.1) only with Admin always the party to whom the call is transferred. Admin's phone rings and Boss is disconnected.

➤ **To hand off a call to Admin:**

- When Boss is in a call (with **Steve**, in the example below), Boss presses the **☰** softkey and selects the **Handoff** option to hand off **Steve** to Admin (**Alan Roberts**).

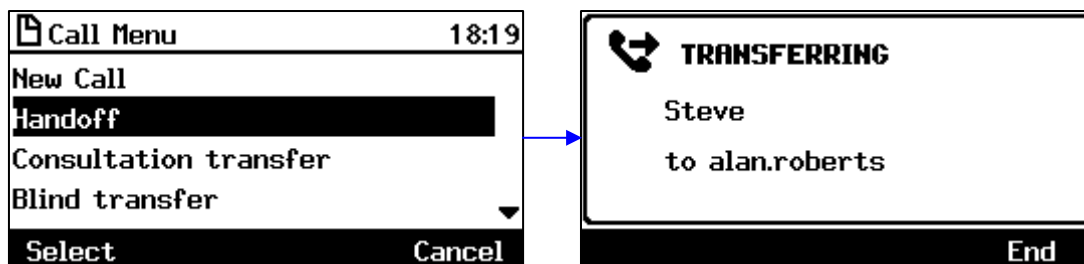

8.3.11 Boss Monitoring Admins, Seizing a Call Put on Hold by an Admin

Boss can monitor Admin when Admin is in a call on Boss' behalf. If Admin's line key on Boss' phone flashes red slowly, it indicates to Boss that Admin is in a call on Boss' behalf. Boss can *long-press* the line key to see at a glance with whom Admin is talking and for how long they've been talking.



In the example above, Admin (Alan Roberts) answered a call on Boss' behalf from Steve. They've been talking for 34 seconds.

- If Boss long-presses the red-flashing line key of Admin (Alan Roberts, in the example below) and Admin has put the call with Steve on hold, Boss will see that the call is on hold and that the **PickUp** option is available.

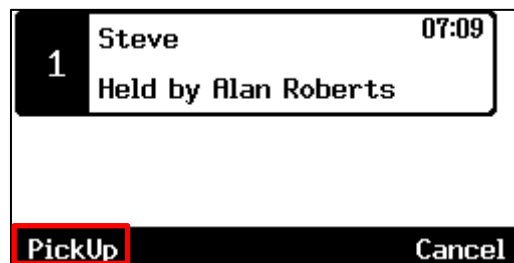

- Boss can press the **PickUp** softkey to seize the call from Admin, who'll be disconnected. Boss can then talk with the other side (Steve).

8.3.12 Admin Picks up a Call from Boss

Admin can pick up a call from Boss:

- A call comes in and Admin determines that Boss has answered it because Admin didn't answer and the Programmable Key on Admin's phone is flashing
- Admin long-presses the Programmable Key to verify that Boss indeed answered and is in a call
- If Boss puts the caller on hold, the **Pick up** softkey displays on Admin's phone
- Admin presses the **Pick up** softkey and picks up the call from Boss

8.3.13 Admin 1 Picks up a Call from Admin 2

Admin 1 can pick up a call from Admin 2:

- A call comes in and Admin 2 answers it *on behalf of Boss*
- Admin 1 sees in Admin 1's screen that Admin 2 has taken the call on behalf of Boss
- Admin 1 long-presses the Programmable Key
- If Admin 2 puts the caller on hold, the **Pick up** softkey displays in Admin 1's screen
- Admin 1 presses the **Pick up** softkey and picks up the call from Admin 2

8.3.14 Admin's Phone Notifies Recipient that Admin's Call is on Behalf of Admin's Boss

Admin's phone notifies the recipient that Admin is calling on behalf of Admin's Boss. This function applies to external recipients as well.

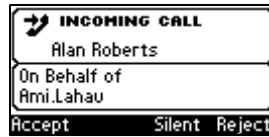

[The screen of another phone model is shown here for illustrative purposes].

8.3.15 Admin Calling Boss, Admin Calling a Recipient on Behalf of Boss

Admin can short-press the Boss' line key on the phone to call Boss or to call a recipient on behalf of Boss.

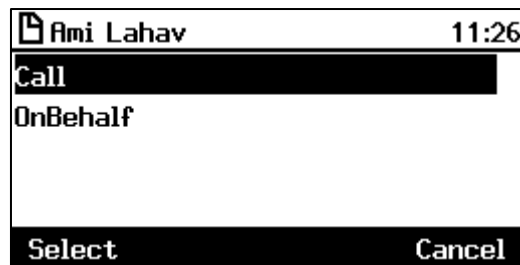

- **Call** = select to call **Boss**
- **OnBehalf** = select to call another recipient on behalf of Boss

8.4 Using the Multiple Boss Admin Feature with the 440HD Sidecar

This section shows how you can benefit from the multiple Boss Admin feature, typically but not exclusively implemented in a hotline or call center environment.

The feature allows multiple relationships to be established between multiple Boss' phones and multiple Admins' phones (up to five Bosses/Admins). The sidecar on the 440HD phone, together with the phone's screen, allow these relationships to be implemented.

The feature streamlines workflow and enhances efficiency between office managers and workers.



Note: Each 440HD phone's screen can support up to five Bosses or Admins.

8.4.1 Displaying a Boss's or an Admin's Active Calls in the Sidecar

This section demonstrates using the multiple Boss Admin feature. In the figure below, you can see two Boss phones: Mike and Alan. They share an Admin, Yaron, whom they delegated in Skype for Business client/server - see the *Administrator's Manual* for setup information.

Table 8-1: Multiple Boss Admin

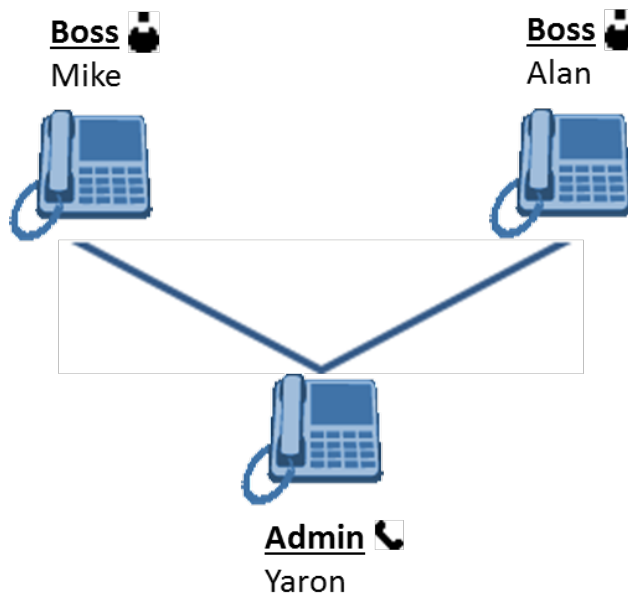

➤ **To view a Boss's active calls:**

1. On Admin's phone's, Admin sees the two Boss lines' softkeys:

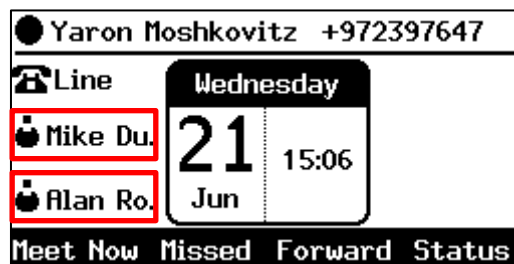

- If the adjacent hard key LED on the phone is illuminated green, Boss is available.
- If it flashes red, Boss is busy.



Note: Similarly, if a Boss has multiple Admins, the Boss can see which Admin is available or busy.

- Admin (Yaron) long-presses Boss's (Alan's) line's hard key, whose red-illuminated LED indicates Boss is busy; the sidecar displays Boss's (Alan's) active calls:

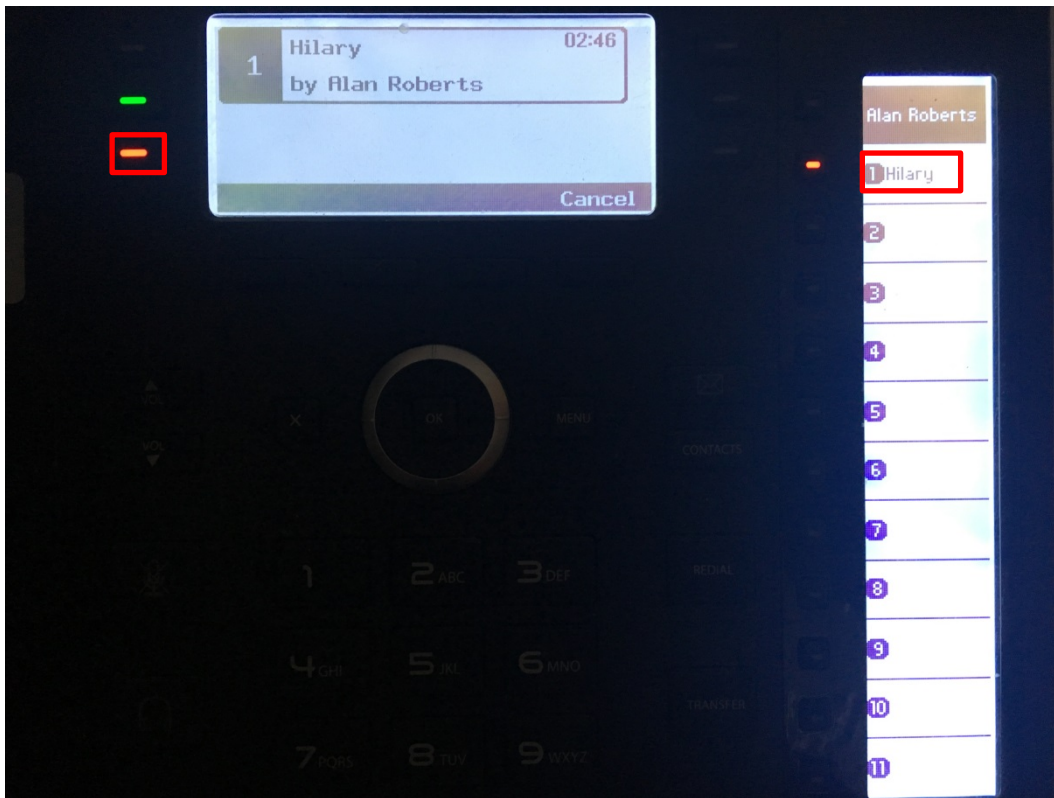

- Admin (Yaron) can long-press the *other* Boss's (Mike's) line's key to display the other Boss's active calls in the sidecar. Admin can toggle between Bosses.



Note: Similarly, if a Boss has multiple Admins, the Boss can similarly toggle between Admins to view each Admin's active calls in the sidecar.

- A call coming in to Admin (Yaron) does not ring on Boss's (Alan's or Mike's) phone.
- A call coming in to Alan, e.g., from Hilary, rings on Yaron's phone and on the phones of all Alan's delegated Admins. On Yaron's phone, an incoming call from Hilary looks like this:

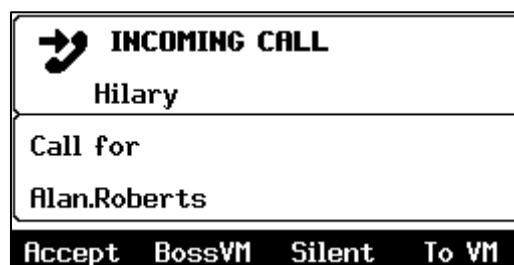

- Similarly, a call coming in to Mike will ring on all Mike's delegated Admins.



Note: If a call comes in to Mike, Alan will not hear or see it because the two Bosses are not delegated to one another - they're unassociated with and unrelated to one another.

8.4.2 Boss Picking up a Call that Admin Put on Hold

Boss can take over a call that Admin answered on behalf of Boss and put on hold.

➤ **To take over a call that Admin answered and put on hold**

1. Admin (Yaron) answers a call coming in from Hilary and puts it on hold.

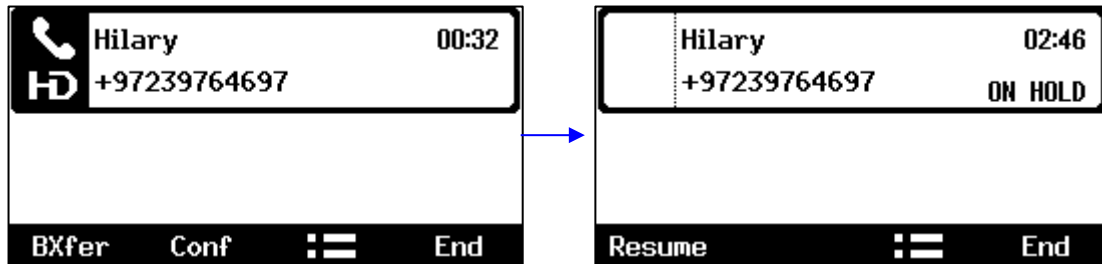

2. Admin notifies Boss (Alan) who by long-pressing Admin's (Yaron's) line key will see Admin's active calls in the sidecar.
3. Boss sees the BLF adjacent to Hilary displayed in the sidecar, flashing red, indicating that Admin is in a call with Hilary but that the call is on hold.
4. Alan presses the BLF LED to pick up the call.

8.5 Viewing and Playing Voicemail Messages

New messages will be in your voicemail box if:

- The Ring LED on the front of the phone is permanently lit blue (see [Figure 2-1](#), label 1).
- An envelope icon is displayed in the phone's screen.
- A stutter dial tone is heard when you pick up the handset.
- The voicemail key on the phone is illuminated red

When you have at least **one new message** in your voicemail box, you can listen to it.

➤ **To view a list of your voicemail messages:**

1. Press the voicemail key:



2. Press the **All** softkey and wait for the list to update.

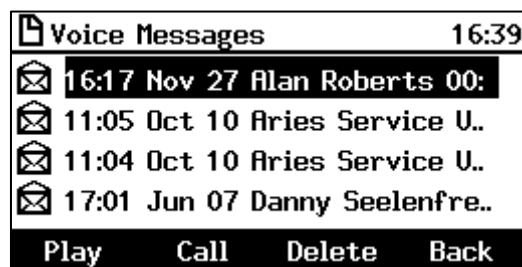

3. Scroll to select from the list which message to **Play**, **Call** or **Delete**.

Note:

For this feature to function:

- Your network administrator must enable private voicemail for you. You must sign in to the phone with your username and password. If you signed in with your PIN code, voicemail will be unavailable and you'll see the message **Your account is not configured for Exchange Unified Messaging**.
- Features like this, activated from Microsoft's Exchange Server, are only available after signing in to the phone with username and password.
- By default, the phone skips PIN code authentication and allows users direct access to voicemail. The network administrators can secure user access to voicemail with PIN code authentication so that when the user presses the voicemail key, they're prompted to enter their PIN code. See the *Administrator's Manual* for details.



When you have at least **one new message** in your voicemail box, you can listen to it.

8.5.1 Sending an Incoming Call Directly to Voicemail

If a time constraint, for example, prevents you from answering an incoming call, you can send it directly to voicemail.

- **To send an incoming call directly to voicemail:**
 - Press the **To VM** softkey displayed when the phone rings.



9 Managing Calls on 2+ Phones with a Delegated Line, Using Sidecars



Note: Applies to the 440HD phone only. Consult the enterprise network administrator in order to set up the feature. For setup information, see the *Administrator's Manual*.

This feature allows configuring two or more phones with the same phone number so that each user in the pool can see, monitor and/or handle incoming calls using the phone's integrated sidecar.

Using the feature, employees may be able to handle calls more effectively and efficiently, enhancing both user and the customer experience.

- Boss and Admin can utilize the sidecar to present active and held calls in the queue.
- Admin can see each Boss queue on the sidecar
- Boss can see all Boss calls in the queue on the sidecar
- A mix of Admin and Boss can be also used in this mode
- Users can still use the sidecar for Speed Dial/BLF. The upper sidecar key allows users to switch between BLF and Boss/Admin queues.

The screenshots below illustrate how the feature works.

Table 9-1: Phone Screen in Idle Mode and Sidecar BLF Keys and Fields

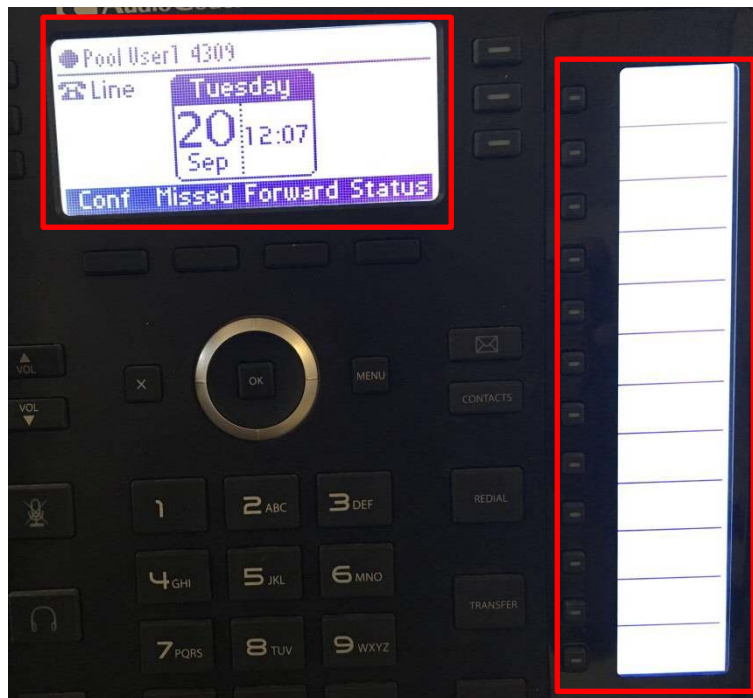

The figure above shows the phone screen (in idle mode) and sidecar (BLF keys and fields) of a phone in the pool.

Table 9-2: Phone A: Answered Incoming Call on Phone A

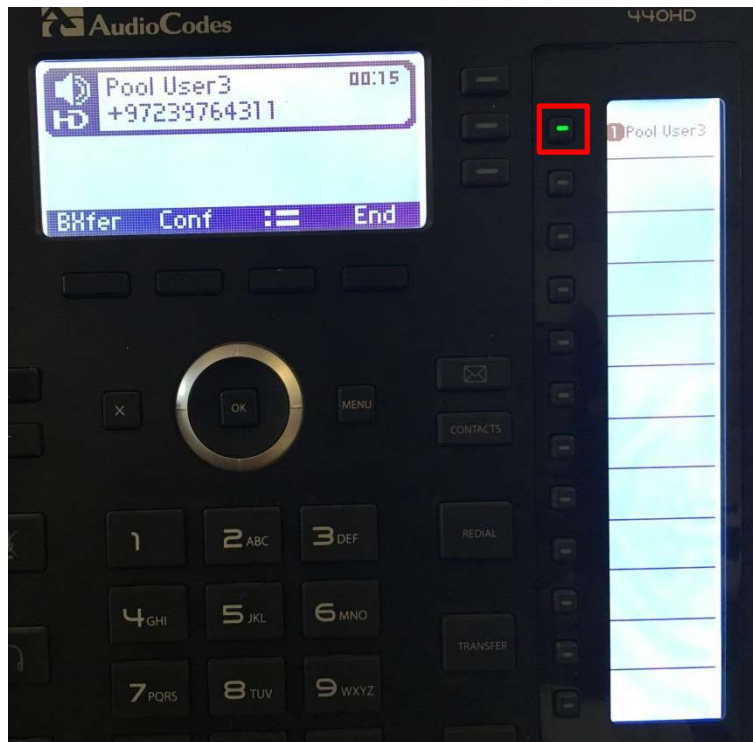

The figure above shows an answered incoming call.
 Steady green BLF key = *active* call on *this* phone (Phone A)
 Flashing green BLF key = *held* call on *this* phone (Phone A)

Table 9-3: Phone B: Answered Incoming Call on Phone A

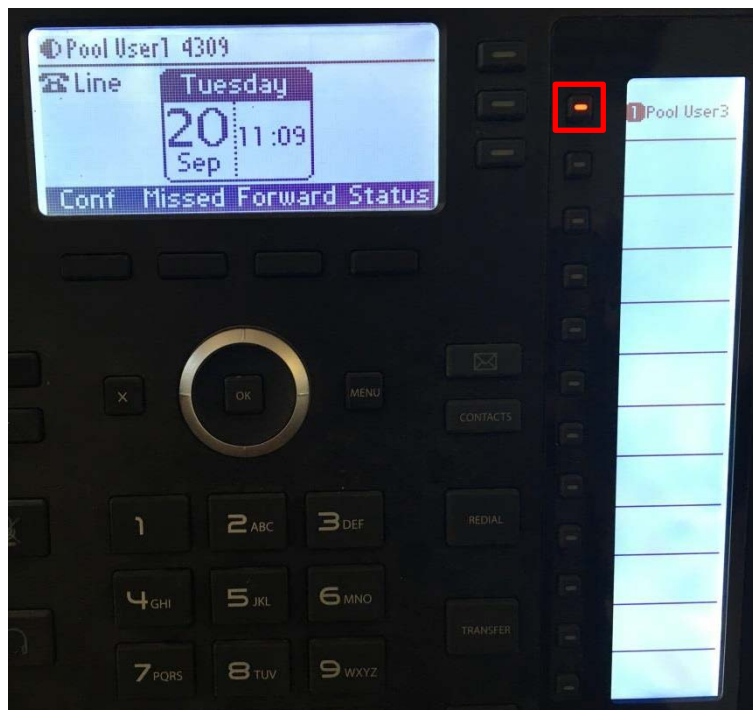

The figure above shows Phone B.
 Steady red BLF key = call answered on phone A
 Flashing red BLF key = call answered on phone A and *put on hold* on phone A

Table 9-4: New Incoming Call

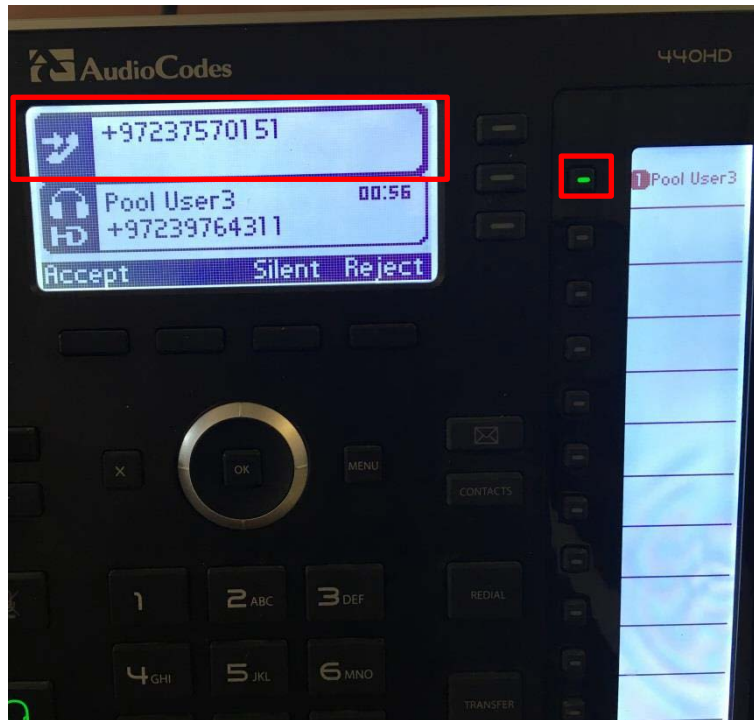

Phone A: The figure above shows a *new* incoming call. Note that it's on top. Note the steady green BLF key indicating the first call that was answered on this phone.

Table 9-5: Answered New Incoming Call

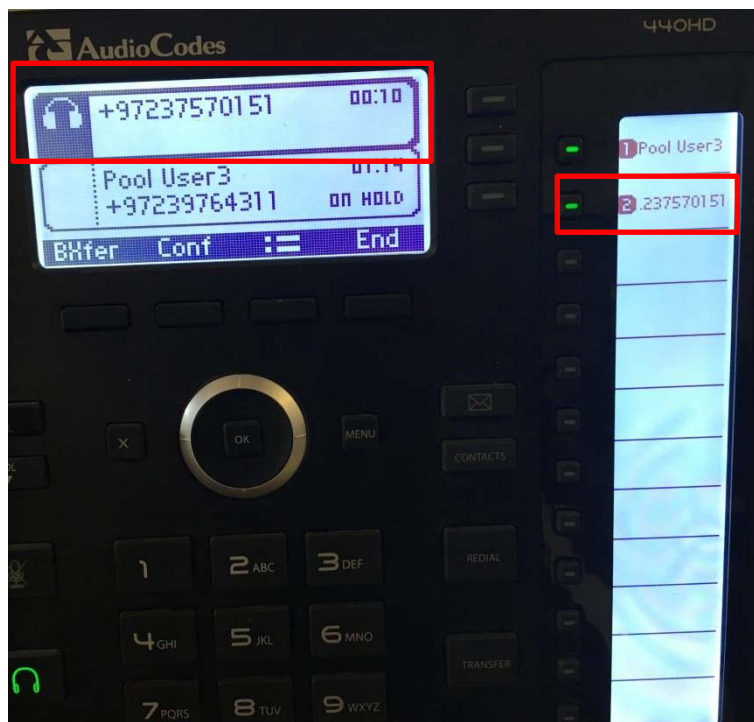

Phone A: The figure above shows an answered new incoming call. It appears in the sidecar BLF field only *after* it is answered.

Steady green BLF key = *active* call on *this* phone (Phone A)

Flashing green BLF key = *held* call on *this* phone (Phone A)

Table 9-6: Phone B: Answered New Incoming Call

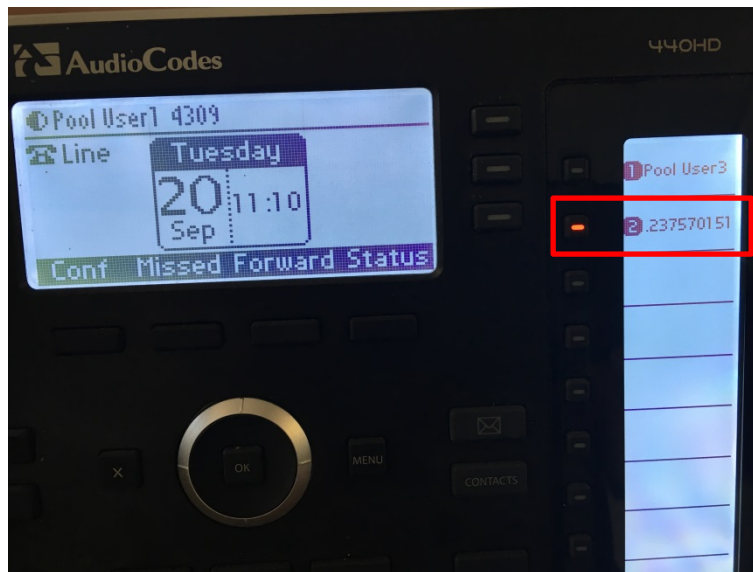

The figure above shows Phone B.

Red BLF key = incoming call answered on Phone A

Flashing red BLF key = incoming call answered on Phone A and *put on hold* on Phone A

Table 9-7: Phone B: Two Red BLF Keys

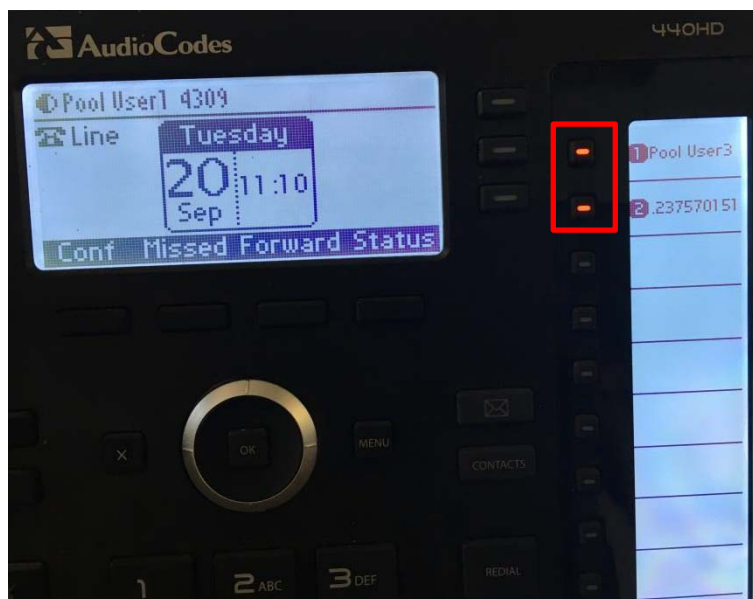

The figure above shows Phone B.

Two red BLF keys = both incoming calls were answered by Phone A.



Note:

- Users can press a BLF key to connect to an active call at any time.
- The feature optimizes the work of users who work in groups.

10 Troubleshooting

Read this section if a problem with a phone occurs. Contact your administrator if necessary.

Table 10-1: Troubleshooting

Symptom	Problem	Corrective Procedure
Phone is off (no screen displays and LEDs)	Phone is not receiving power	<ul style="list-style-type: none"> Verify that the AC/DC power adapter is attached firmly to the DC input on the rear of the phone. Verify that the AC/DC power adapter is plugged into the electrical outlet. Verify that the electrical outlet is functional. If using Power over Ethernet (PoE), contact your network administrator to check that the switch is powering the phone.
'LAN Link Failure' message displayed on screen	No LAN connection	<ul style="list-style-type: none"> Verify that the LAN cable is connected securely to the LAN port on the rear of the phone. Verify that the other end of the LAN cable is connected to the network (switch). If it's not, inform your network administrator.
Phone is not ringing	Ring volume is set too low	<ul style="list-style-type: none"> Increase the volume (see Section 6.13.1)
Screen display is poor	Screen settings	<ul style="list-style-type: none"> Adjust the phone's screen contrast level (see Section 6.7) Adjust the screen's backlight timeout (see Section 6.8)
Headset has no audio	Headset not connected properly	<ul style="list-style-type: none"> Verify that your headset is securely plugged into the headset port located on the side of the phone. Verify that the headset volume level is adjusted adequately (see Section 6.13.5).

10.1 Uploading Logs to MS Server for Support Purposes

An integrated log upload feature allows network administrators to upload logs from the phone to the Microsoft server for troubleshooting/support purposes, in compliance with Microsoft's certification requirements for 3rd party Skype for Business clients. If a user experiences an irregularity such as poor voice quality, they'll contact an AudioCodes Field Application Engineer (FAE) who will instruct them to upload and send the logs for analysis. The FAE then downloads the logs to their PC, performs the analysis, and provides a fix.

➤ **To perform log upload:**

- Press the MENU hard key and scroll down to select **Log upload**.

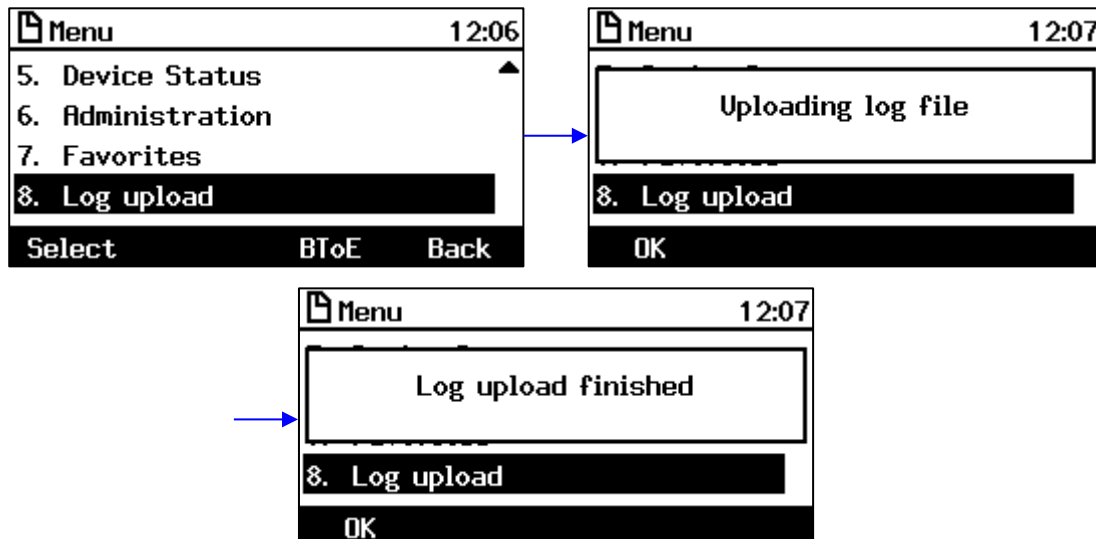

International Headquarters

1 Hayarden Street,
Airport City
Lod 7019900, Israel
Tel: +972-3-976-4000
Fax: +972-3-976-4040

AudioCodes Inc.

27 World's Fair Drive,
Somerset, NJ 08873
Tel: +1-732-469-0880
Fax: +1-732-469-2298

Contact us: <https://www.audiocodes.com/corporate/offices-worldwide>

Website: <https://www.audiocodes.com/>

©2018 AudioCodes Ltd. All rights reserved. AudioCodes, AC, HD VoIP, HD VoIP Sounds Better, IPmedia, Mediant, MediaPack, What's Inside Matters, OSN, SmartTAP, User Management Pack, VMAS, VoIPerfect, VoIPerfectHD, Your Gateway To VoIP, 3GX, VocaNom, AudioCodes One Voice and CloudBond are trademarks or registered trademarks of AudioCodes Limited. All other products or trademarks are property of their respective owners. Product specifications are subject to change without notice.

Document #: LTRT-13220

