

C448HD | C450HD IP Phones

Microsoft Teams Application

Version 1.4.208



Notice

Information contained in this document is believed to be accurate and reliable at the time of printing. However, due to ongoing product improvements and revisions, AudioCodes cannot guarantee accuracy of printed material after the Date Published nor can it accept responsibility for errors or omissions. Updates to this document can be downloaded from <https://www.audiocodes.com/library/technical-documents>.

This document is subject to change without notice.

Date Published: June-25-2020

WEEE EU Directive

Pursuant to the WEEE EU Directive, electronic and electrical waste must not be disposed of with unsorted waste. Please contact your local recycling authority for disposal of this product.

Customer Support

Customer technical support and services are provided by AudioCodes or by an authorized AudioCodes Service Partner. For more information on how to buy technical support for AudioCodes products and for contact information, please visit our website at <https://www.audiocodes.com/services-support/maintenance-and-support>.

Documentation Feedback

AudioCodes continually strives to produce high quality documentation. If you have any comments (suggestions or errors) regarding this document, please fill out the Documentation Feedback form on our website at <https://online.audiocodes.com/documentation-feedback>.

Stay in the Loop with AudioCodes



Related Documentation

Document Name
C450HD IP Phone for Microsoft Teams Quick Guide
C450HD IP Phone for Microsoft Teams Release Notes
https://docs.microsoft.com/en-us/MicrosoftTeams/phones-for-teams

Table of Contents

1	Overview	1
	Specifications	1
2	Setting up the Phone	5
	Unpacking	5
	Device Description	6
	Front View	6
	Rear View	8
	Cabling	9
	Mounting the Phone	10
	Desktop Mounting	10
	Routing the Handset Cable	11
	Wall Mounting	11
3	Starting up	13
	Configuring Device Settings	13
	Restoring the Phone to Default Settings	31
	Performing a Hard Restore	31
	Performing a Soft Restore	31
	Locking and Unlocking the Phone	32
	Automatic Lock	33
	Smart Unlock	33
4	Teams Application	35
	Signing In	35
	Getting Acquainted with the Phone Screen	37
	Changing Presence Status	39
	Configuring Teams Application Settings	41
	Setting up a Meeting	44
	Using the People App	45
	Accessing Voicemail	47
	Using Audio Devices	48
	Signing Out	48
5	Performing Basic Operations	49
	Making a Call	49
	Redialing	51
	Dialing a Missed Call	51
	Making an Emergency Call	51
	Answering Calls	52
	Ending an Established Call	54
	Managing Calls	54
	Parking a Call	56
	Initiating a Teams Meeting	56

Using Live Captions	59
Raising a Hand During a Meeting	59
Transferring a Call to Frequent Contacts	60
Viewing and Playing Voicemail Messages	60
Rejecting an Incoming Call, Sending it Directly to Voicemail	62
Adjusting Volume	62
Adjusting Ring Volume	62
Adjusting Tones Volume	62
Adjusting Handset Volume	63
Adjusting Speaker Volume	63
Adjusting Headset Volume	63
Managing Meetings	64
Better Together over Bluetooth	65
6 Updating C450HD Phone Firmware Manually	67
7 Troubleshooting	69
Users	69
Network Administrators	69
Collecting Logs	69
Remote Logging	71
Diagnostic Data	72
SSH	74
Capturing the Phone Screen	74
Running the tcpdump Tool	75
Activating DSP Recording	75
Deactivating DSP Recording	75
Getting the Phone IP Address	76
Getting Information about Phones	76
Installing the Teams APK (or Any Other APK) using SSH	77
Getting Company Portal Logs	77
Getting Audio Debug Recording Logs	79
Collecting Media Logs (*.blog) from the Phone	79

1 Overview

The AudioCodes C448HD and C450HD IP phones are native Microsoft Teams high-end executive business phones with a large color touch screen and full UC integration for the Native Microsoft Teams Online market.

The Microsoft Teams C448HD and C450HD phones are equipped with a 5-inch color capacitive touch screen of 1280 x 720 resolution.



The C448HD phone is identical to the C450HD phone from the user's point of view, with the exception of:

- The C448HD phone does not allow the 'Switch to Skype' feature (in the Admin debugging tab); the C450HD allows this feature.
- The C448HD phone does not feature Bluetooth and Wi-Fi; the C450HD phone features optional integrated Wi-Fi and Bluetooth support (contact your local AudioCodes representative for more information about regional availability).
- The C448HD phone features one USB port; the C450HD phone features two.
- The C448HD phone does not feature an option to add the Expansion Module; the C450HD phone features this option.

The phones can be managed by the Microsoft Teams & Skype for Business Admin Center. For more information, see <https://docs.microsoft.com/en-us/MicrosoftTeams/phones-for-teams>.

AudioCodes' Device Manager and AudioCodes' Redirect Server are also supported for monitoring, upgrading and configuring the devices (released in version 1.4.208 as a beta with a limited set of features).

The phones feature the option to be used as a Microsoft Skype for Business IP phone, offered as part of AudioCodes' Managed IP Phones solution which defines the IP phone as an IT-managed entity and delivers unique and complete lifecycle management of end-user desktop devices. A single-click switchover between Microsoft Teams with native client experience and Skype for Business is supported.

Specifications

The following table summarizes the software specifications of the C448HD and C450HD IP Phones for Microsoft Teams.

Table 1-1: C448HD and C450HD IP Phones for Microsoft Teams Software Specifications

Feature	Details
Media Processing	<ul style="list-style-type: none"> ■ Voice Coders: G.711, G.729, G.722, SILK Opus ■ Acoustic Echo Cancellation: G.168-2004 compliant, 64-msec tail length ■ Adaptive Jitter Buffer ■ Voice Activity Detection

Feature	Details
	<ul style="list-style-type: none"> ■ Comfort Noise Generation ■ Packet Lost Concealment ■ RTP/RTCP Packetization (RFC 3550, RFC 3551), SRTP (RFC 3711)
Microsoft Teams phones feature set	<ul style="list-style-type: none"> ■ Authentication (Sign in with user credentials; Sign in using PC/Smartphone; Modern Authentication; Phone lock/unlock) ■ Calling (Incoming/Outgoing P2P calls; In-call controls via UI (Mute, hold/resume, transfer, end call); PSTN calls; Visual Voicemail; 911 support) ■ Calendar and Presence (Calendar Access and Meeting Details; Presence Integration; Exchange Calendar Integration; Contact Picture Integration; Corporate Directory Access) ■ Meetings (One-click Join for Meetings; Join Skype for Business meetings; Meeting Call controls [Mute/unmute, hold/resume, hang up, add/remove participant]; Meeting Details. See also https://docs.microsoft.com/en-us/MicrosoftTeams/phones-for-teams.
Configuration / Management	<ul style="list-style-type: none"> ■ Microsoft Teams & Skype for Business Admin Center (Provisioning and Logging) ■ AudioCodes Device Management and AudioCodes Redirect Server for monitoring, upgrading and configuring (Beta as of 1.4.208)
Debugging Tools	<ul style="list-style-type: none"> ■ Log upload to Microsoft server (certification for 3rd party Skype for Business clients) ■ Remote logging via Syslog ■ SSH Access ■ Capturing the phone screen ■ TCPdump ■ Company Portal (Intune) logs ■ Audio Debug recording logs ■ Media logs (*.blog)
Localization Support	<ul style="list-style-type: none"> ■ Multi-lingual support; the language pack list is not yet final and is subject to modification.
C448HD and C450HD	<ul style="list-style-type: none"> ■ Five-inch color capacitive touch screen, 1280 x 720 resolution, with an intuitive user interface.

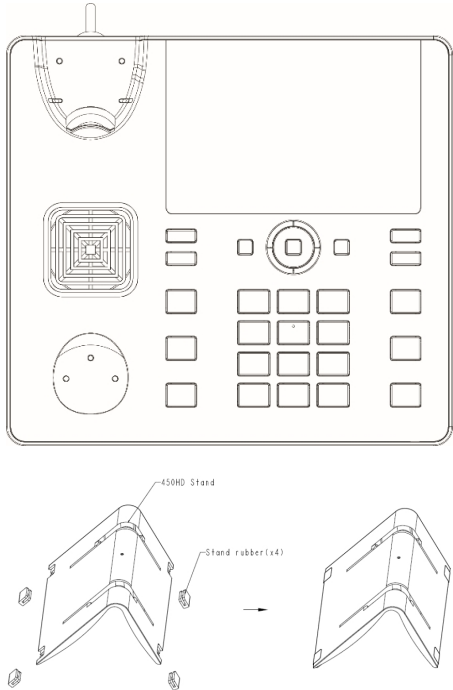

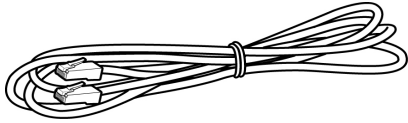
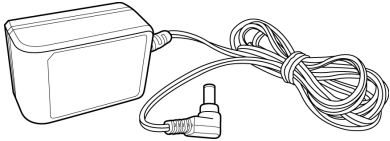
Feature	Details
Hardware	<ul style="list-style-type: none"> ■ Wired connectivity: <ul style="list-style-type: none"> ✓ Two RJ-45 [Gigabit Ethernet (GbE)] (10/100/1000BaseT Ethernet) ports for WAN and LAN ✓ RJ-9 port (jack) for headset ✓ RJ-9 port (jack) for handset ✓ 2 x USB ports for headset support (C450HD); 1 x USB port for headset support (C448HD) ✓ RJ-11 interface ■ Wireless connectivity (C450HD only): <ul style="list-style-type: none"> ✓ Single band 2.4GHz, 802.11b/g/n Wi-Fi support ✓ Wi-Fi supported protocols: WEP, WPA-PSK/WPA2-PSK and WPA/WPA2 Enterprise (802.1X) PEAP only ■ Integrated optional Bluetooth support (C450HD only) (Currently supported at a Beta level) ■ Expansion Module (C450HD only) ■ Mounting: <ul style="list-style-type: none"> ✓ Wall and desktop mounting options ✓ One angle for desktop mount, another angle for wall mount ■ Power: <ul style="list-style-type: none"> ✓ DC jack adapter 12V ✓ Power supply AC 100 ~ 240V ✓ PoE Class 3: IEEE802.3af (optional) ■ Keys: <ul style="list-style-type: none"> ✓ VOICE MAIL message hotkey (including LED) ✓ 4-way navigation button with OK key ✓ MENU ✓ REDIAL ✓ HOLD ✓ MUTE (including LED) ✓ TRANSFER ✓ VOLUME control key

Feature	Details
	<ul style="list-style-type: none"><li data-bbox="560 271 903 304">✓ HEADSET (including LED)<li data-bbox="560 327 895 360">✓ SPEAKER (including LED)<li data-bbox="560 383 820 416">✓ BACK (the 'x' key)<li data-bbox="560 439 740 472">✓ CONTACTS

2 Setting up the Phone

Unpacking

When unpacking, make sure the following items are present and undamaged:

Phone / Stand	Handset / Cord
	
Cat 5e Ethernet Cable	AC Power Adapter (Optional)
	

If anything appears to be missing or broken, contact the distributor from whom you purchased the phone for assistance.

Device Description

Use the next graphics to identify and familiarize yourself with the device's hardware functions.

Front View

The front view of the phone is shown in the figure and described in the table.

Figure 2-1: Front View

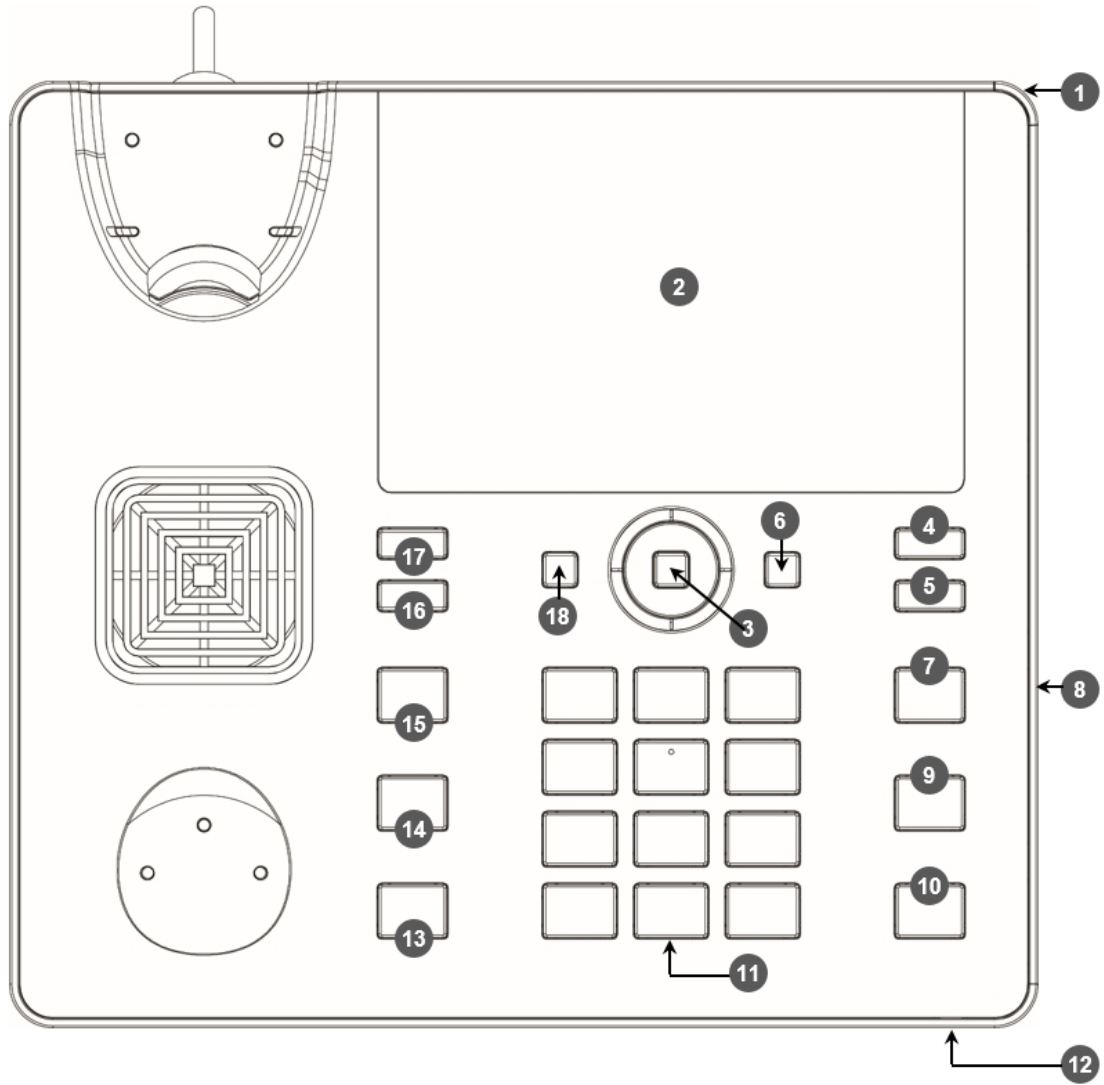


Table 2-1: Font View Description

Item #	Label/Name	Description
1	Ring LED	Indicates phone status: <ul style="list-style-type: none"> ■ Green: Idle state ■ Flashing blue: Incoming call (ringing)

Item #	Label/Name	Description
		<ul style="list-style-type: none"> ■ Red: Answered call
2	TFT touch screen	Thin Film Transistor touch screen, a type of LCD (Liquid Crystal Display) interactive screen which displays calling information and lets you configure phone features by touching the glass.
3	Navigation Control / OK	<ul style="list-style-type: none"> ■ Press the button's upper rim to scroll up menus/items. ■ Press the button's lower rim to scroll down. ■ Press the button's left or right rim to move the cursor left or right (when editing a contact number for example). ■ Press OK to select a menu/item/option.
4	Voicemail	Retrieves voicemail messages.
5	CONTACTS	Accesses the People screen.
6	MENU	Accesses the Settings screen.
7	REDIAL	Accesses a list of recently dialed numbers; one can be selected to redial.
8	Kensington lock	Allows locking the device.
9	TRANSFER	Transfers a call.
10	HOLD	Places an active call on hold.
11	Alphanumerical Keypad	Keys for entering numbers, alphabetical letters and symbols (e.g., colons)
12	Microphone	Allows talking and listening. The network administrator can disable it if required.
13	Speaker	Activates the speaker, allowing a hands-free conversation.
14	Headset	Activates a call using an external headset.
15	Mute	Mutes a call.
1617	▲ VOL	Increases or decreases the volume of the handset, headset, speaker, ring tone and call progress tones.
	▼ VOL	
18	x	Used as a 'Back' key to return to the previous screen.

Rear View

The rear view of the phone is shown in the figure and described in the table.

Figure 2-2: Rear View

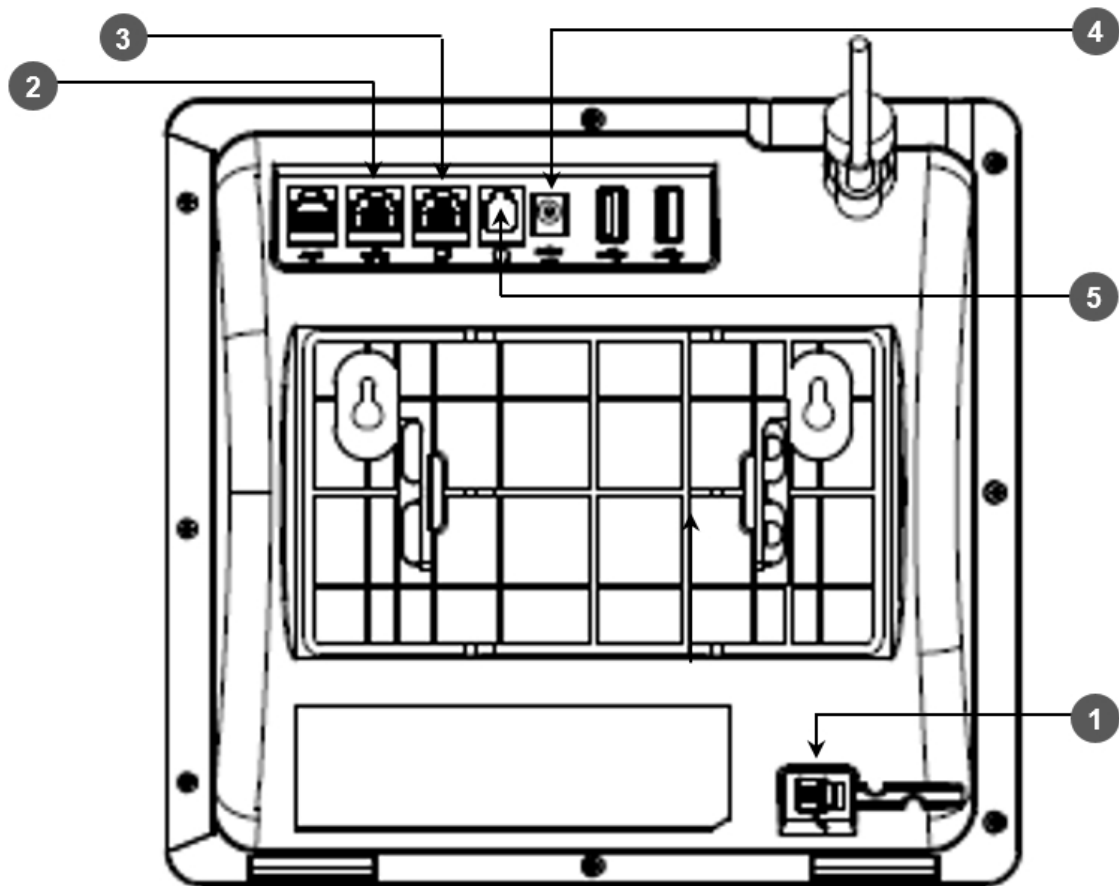







Table 2-2: Rear View Description

#	Label	Description
1		Handset jack, i.e., port RJ-9, to connect the handset.
2		RJ-45 port to connect to the Ethernet LAN cable for the LAN connection (uplink - 10/100/1000 Mbps). If you're using Power over Ethernet (PoE), power to the phone is supplied from the Ethernet cable (draws power from either a spare line or a signal line).
3		RJ-45 port to connect the phone to a PC (10/100/1000 Mbps downlink).
4	 DC12V	12V DC power jack that connects to the AC power adapter.
5		Headset jack, i.e., RJ-9 port that connects to an external headset.

Cabling

The documentation following shows how to cable your phone. Use the figure and table as reference.

Figure 2-3: Cabling the Phone

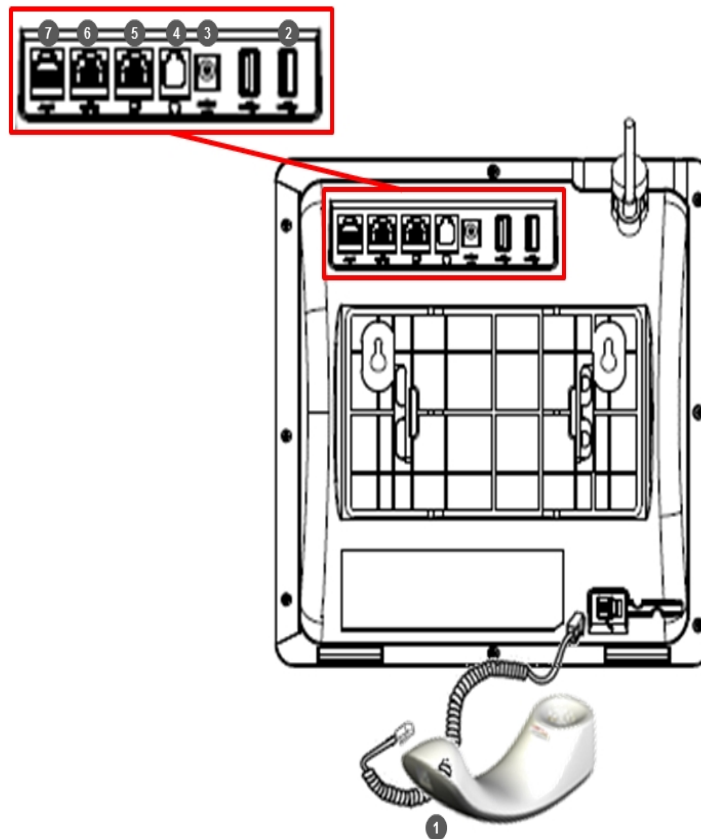


Table 2-3: Cabling the Phone

Action	Description
1	Connect the phone's RJ-9 port to the handset cord's longer, straight end. Connect the handset to the handset cord's short, straight end.
2	Connect one of the two USB ports to a headset [optional].
3	Connect the phone's power socket labelled DC 12V to the connector tip of the AC power adapter. Connect the two-prong AC adapter directly to the electrical wall outlet. When the phone powers up, all the LEDs momentarily light up.
4	Connect the phone's RJ-9 headset jack to a headset [optional]

Action	Description
5	Connect the RJ-45 PC port to a computer/laptop, using a CAT 5 / 5e straight-through Ethernet cable
6	Connect the phone's RJ-45 LAN port to your LAN network (LAN port or LAN switch/router) using a CAT 5 / 5e Ethernet cable.
7	Internal use only. FAEs use the port to debug and troubleshoot the phone - after connecting the AUX (auxiliary) port to a terminal monitor with a serial cable.



If the LAN to which the phone is connected supports Power over Ethernet (PoE), no AC adapter is required; the phone receives power from the Ethernet network.



Prior to connecting power, refer to the *Compliance and Regulatory Information* at www.audiocodes.com/library.

Mounting the Phone

The phone can be mounted on a:

- Desk (see [Desktop Mounting](#) below)
- Wall (see [Wall Mounting](#) on the next page)

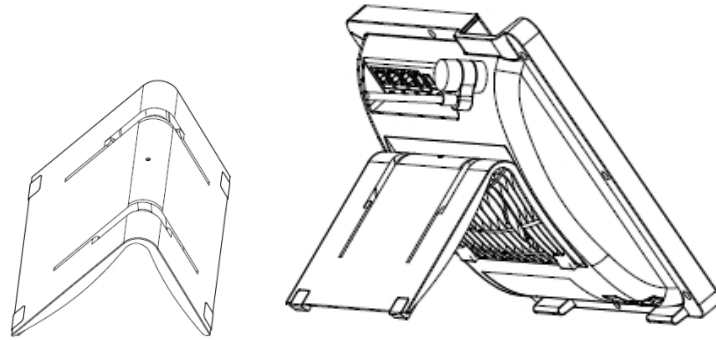
See also <https://www.youtube.com/watch?v=oGe9STB9IFE> to assemble the base stand.

Desktop Mounting

The documentation following shows how to mount the phone on a flat surface like a desk.

➤ To mount the phone on a flat surface like a desk:

1. Off-hook the handset (if on-hook) and place the phone upside down, i.e., base-up, on your desktop.
2. On the phone's stand, identify outer notches.
3. On the phone's base, identify outer rails.
4. Invert the stand and align its outer notches with the base's outer rails.
5. Insert the stand's outer notches into the base's outer rails and slide the notches along the rails until the stand click-locks into the base.
6. Revert the phone and stand it on the desktop.



Routing the Handset Cable

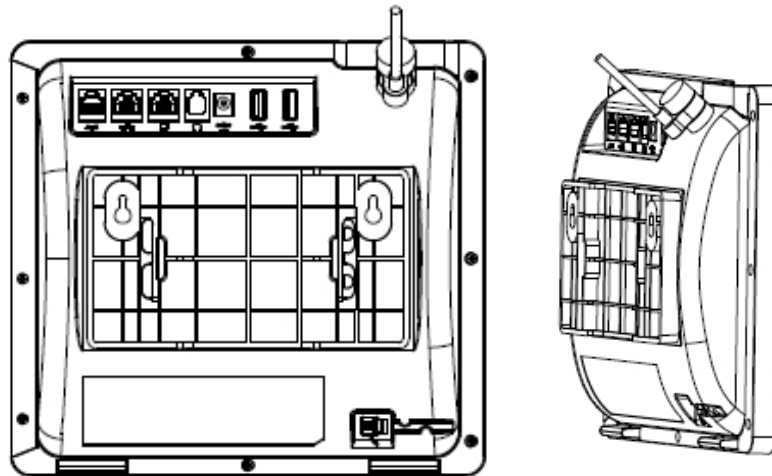
The phone features a groove for routing the handset cable.

Wall Mounting

The documentation following shows how to mount the phone on a wall.

➤ To mount the phone on a wall:

1. Attach the stand of the phone for the purpose of a wall mounting:
 - a. Detach the base.

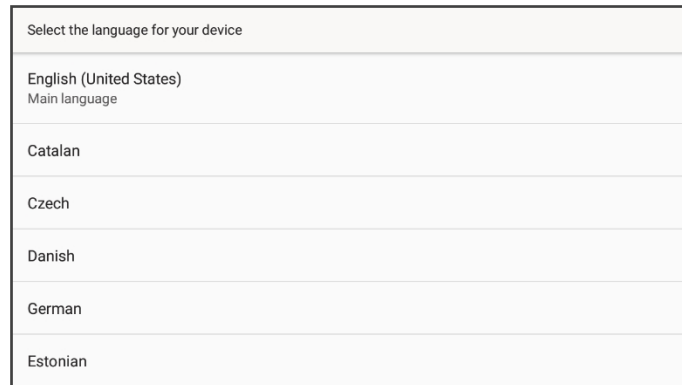


- b. Attach it again as you did for a desktop mounting (see [Desktop Mounting](#) on the previous page) only now make sure that it's flatly aligned to lie flush against the wall, i.e., slide the inner rails of the phone stand onto the phone base's inner notches.
2. Connect the AC power adapter, LAN and PC/laptop cords.
3. In the wall, drill two horizontal holes at a distance of 3 15/16 inches (100 mm) from one another, in line with the template.
4. Insert two masonry anchors into the holes if necessary.

5. Thread two screws (not supplied) into the two masonry anchors; ensure that the heads extend sufficiently (about 3/16 inch or 5 mm from the wall) for the phone stand's keyhole slots to hang on.
6. Hang the phone stand's keyhole slots on these screws.

3 Starting up

After connecting the phone to the network (or resetting it), a start-up wizard opens displaying by default the 'Select the language for your device' screen.




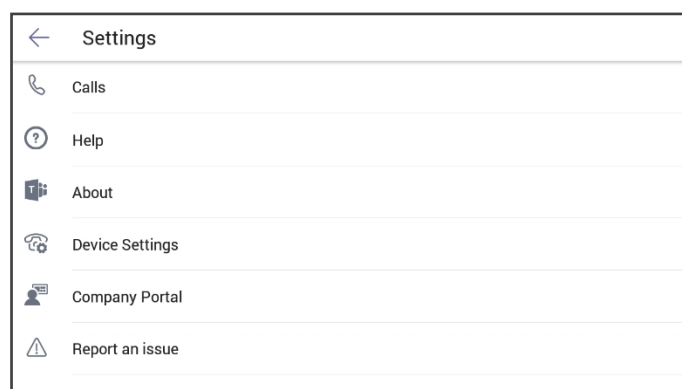
Configure the language of your choice and then configure device settings to match specific requirements. Only if the phone is restored to default settings will it be necessary to repeat this.

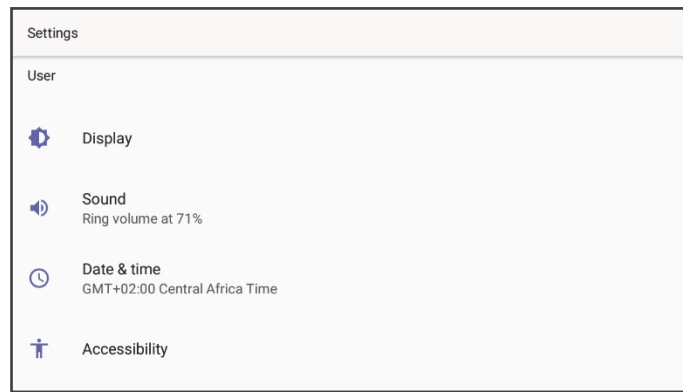
Configuring Device Settings

The section familiarizes you with the device's settings. Devices are delivered to customers configured with their default settings. Customers can customize these settings to suit enterprise requirements.

➤ To access device settings:


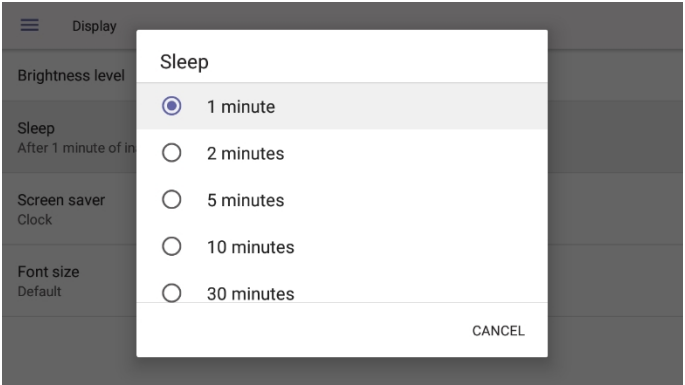
1. In the phone's idle screen, touch the  menu, touch **Settings** and then **Device Settings**. Alternatively, press the hard MENU key on the phone.


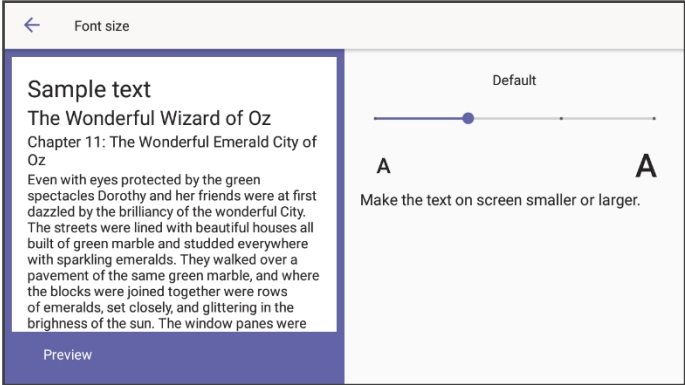





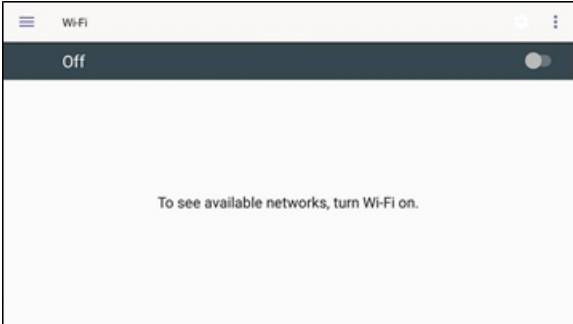



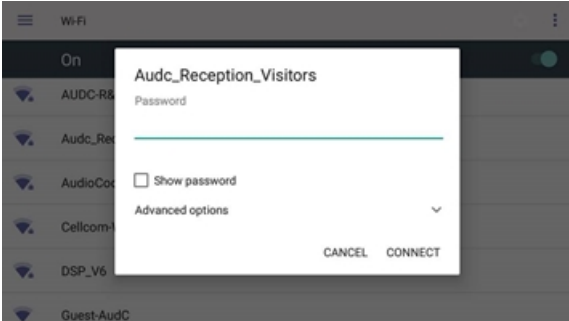
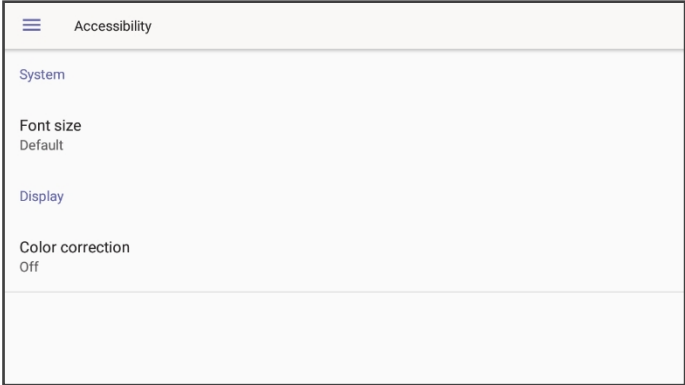

2. Swipe down to navigate to and open a setting. Use this table as reference.

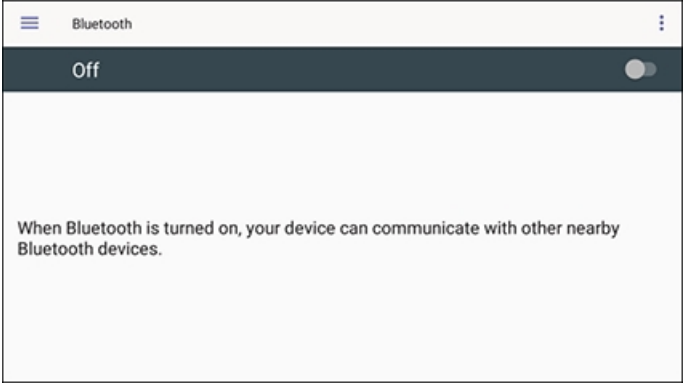

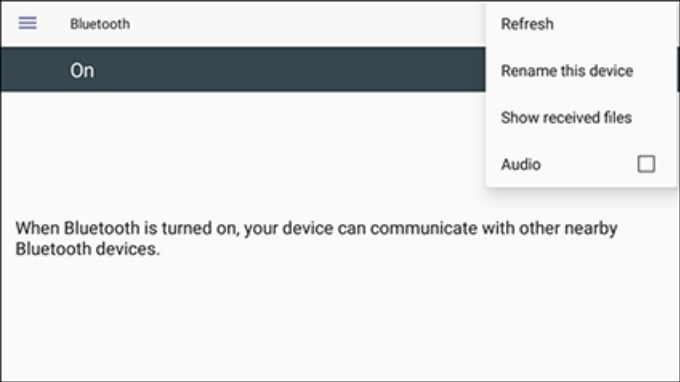
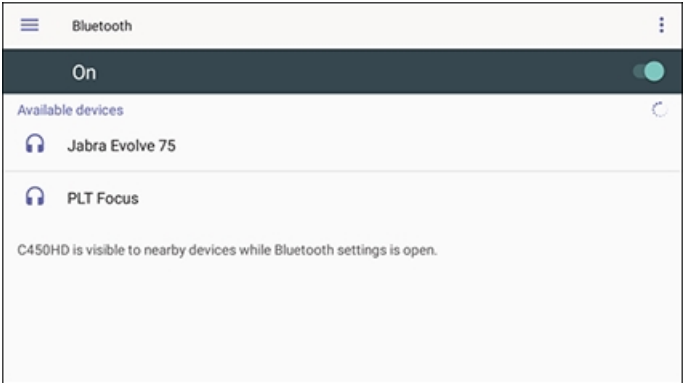
Table 3-1: Device Functions Settings Descriptions


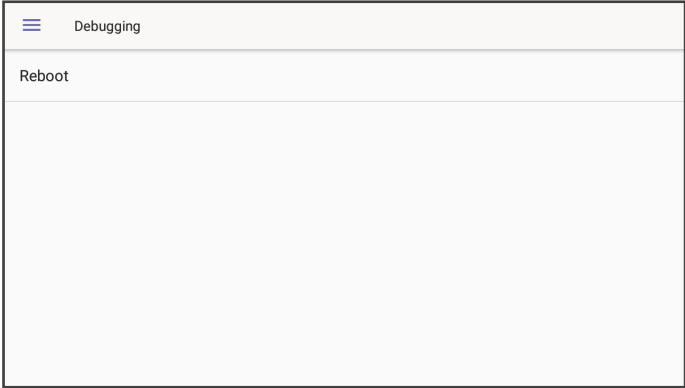

Setting	Description
Login to the Device as Regular User	
<p>Display</p>	<p>Opens the 'Display' screen [Brightness level].</p>  <p>The phone's screen supports different brightness levels. Customers can choose the level that best suits requirements.</p> <p>■ Sleep</p>  <p>■ Screen saver</p>

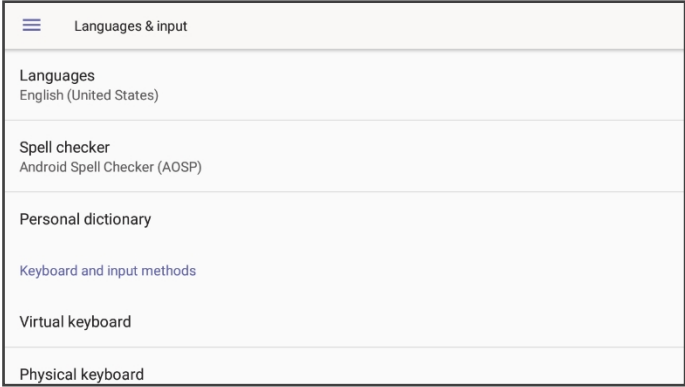
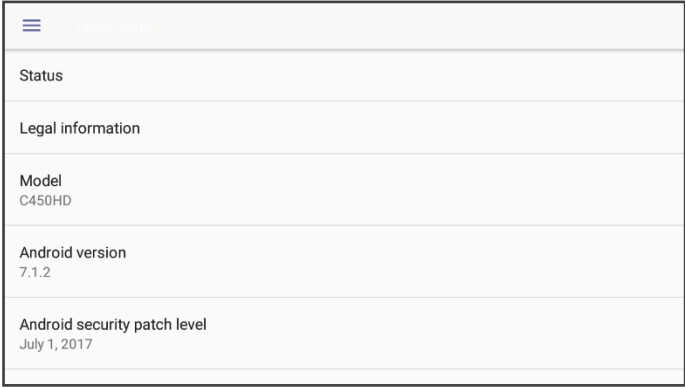
Setting	Description
	 <p>■ Font size</p> 
<p>Sound</p>	<p>Allows you to customize phone volume to create a friendlier user experience.</p> <p>Ring volume at n%</p> 
<p>Date & time</p>	<p>Date and time are automatically retrieved from the deployed Network Time Protocol (NTP) server.</p>

Setting	Description
	 <p>Use 24-hour format [Allows you to select the Time format]</p>
<p>Wi-Fi</p>	<p>The phone can connect to an Access Point via Wi-Fi. To enable Wi-Fi:</p> <ol style="list-style-type: none"> 1. Access the Device Settings screen and select Wi-Fi.  <ol style="list-style-type: none"> 2. Switch Wi-Fi to On to view the list of possible SSIDs (Service Set Identifier).  

Setting	Description
	<p>3. Select an SSID, configure the required credentials, and then touch CONNECT:</p> 
<p>Accessibility</p>	<p>Allows making the screen reader friendlier.</p> 
<p>Bluetooth</p>	<p>[Applies only to C450HD] [Bluetooth support is provided under Android as a Beta] Hands free profile where the phone is able to connect to Bluetooth headset or speaker.</p> <p>To enable Bluetooth:</p> <ol style="list-style-type: none"> 1. Press the MENU hard key on the phone to access the Device Settings screen.  <ol style="list-style-type: none"> 2. Select Bluetooth.

Setting	Description
	 <p>When Bluetooth is turned on, your device can communicate with other nearby Bluetooth devices.</p> <p>3. Switch the feature on and then press  shown in the upper right corner of the preceding screen to find available Bluetooth devices.</p>  <p>When Bluetooth is turned on, your device can communicate with other nearby Bluetooth devices.</p> <p>4. [Optional] Select the Audio check box to view only audio devices.</p> <p>5. Pair your Bluetooth USB headset and then touch Refresh.</p>  <p>When Bluetooth is turned on, your device can communicate with other nearby Bluetooth devices.</p> <p>6. Select the device you require; it's then connected to Bluetooth.</p>
Power Saving	Allows users to contribute to power saving in the enterprise.



Setting	Description
	 <p>Enable power saving Office hours start time [The device consumes minimal energy before the user arrives at the office] Office hours end time [The device consumes minimal energy after the user leaves the office]</p>
Debugging	<p>Enables users to reboot the device.</p>  <p>Log in as Administrator (MENU key on the phone > Admin) for more debugging settings to be available.</p>
Security	<p>Helps secure the enterprise telephony network against breaches.</p>  <p>Screen lock [The phone automatically locks after a configured period to</p>


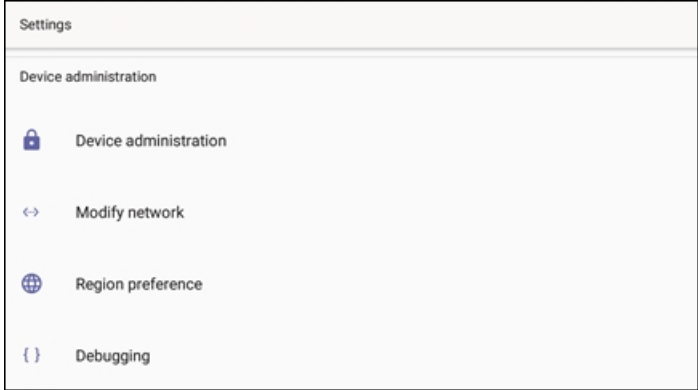

Setting	Description
	<p>secure it against unwanted use. If left untouched for 10 minutes (default), it automatically locks and is inaccessible to anyone who doesn't know its lock code.]</p> <p>Make passwords available</p> <p>Storage type</p> <p>Trusted credentials</p> <p>User credentials</p> <p>Install from SD card</p> <p>Clear credentials</p>
Touch screen	Allows users to disable the phone’s touch screen.
Languages & input	<p>Allows users to customize inputting to suit personal requirements.</p> 
About [Android 7.1.2]	<p>Enables users to determine device information.</p>  <p>To determine the device’s IP address, select the ‘Status’ option.</p>


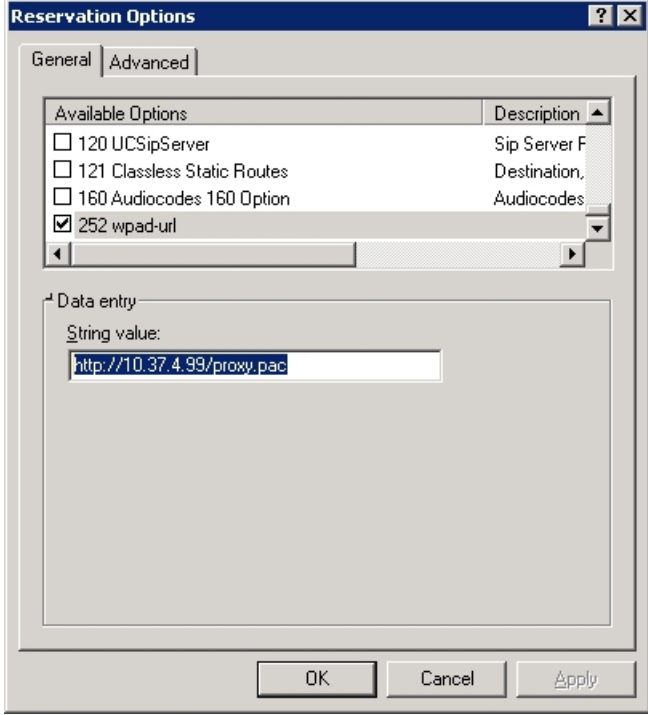
Setting	Description
	<div data-bbox="531 264 1219 647"> <p>← Status</p> <p>IP address fe80::290:8fff:fe9a:f77d 10.13.2.159</p> <p>MAC address 00:90:8F:9A:F7:7D</p> <p>Serial number SC10155901</p> <p>Up time 51:04:34</p> </div> <p>To get information about the version, select 'Android version'.</p> <div data-bbox="531 714 1219 1055"> <p>← Version info</p> <p>Firmware version C450HD_TEAMS_0.314</p> <p>Firmware code 314</p> <p>Bootloader 1.0.43</p> <p>Microsoft Teams version Version name: 1449/1.0.94.2019052106 Version code: 2019506060</p> <p>Company Portal version</p> </div> <div data-bbox="531 1075 1219 1339"> <p>← Version info</p> <p>Microsoft Teams version Version name: 1449/1.0.94.2019052106 Version code: 2019506060</p> <p>Company Portal version Version name: 5.0.4295.0 Version code: 3084516</p> <p>Admin Agent version Version name: 1.0.0.201812061458.product Version code: 42</p> <p>Partner Agent version Version name: 1.0.28 Version code: 51</p> </div>
Login to the Device as Admin	
<p>Device administration</p>	<p>Allows the user to log in as Administrator, necessary for some of the debugging options. It is password protected. Default password: 1234 (or 1111 in early versions). After logging in as an Administrator, the user can log out change password.</p> <p>To log in as Administrator: Press the MENU key on the phone.</p>

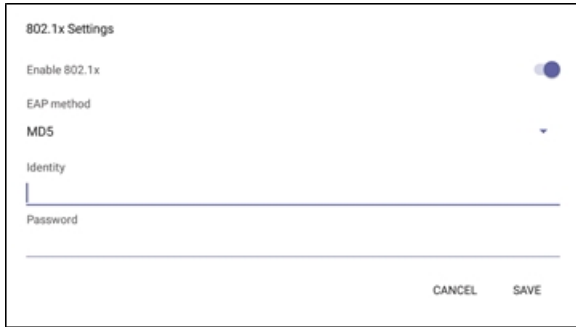

Setting	Description
	<div data-bbox="531 264 1219 636"> <p>Settings</p> <hr/> <p>Device administration</p> <ul style="list-style-type: none"> Device administration Modify network Region preference Debugging </div> <p>Touch the Device administration option.</p> <div data-bbox="531 703 1219 1086"> <p>Device administration</p> <hr/> <p>Login</p> </div> <p>Touch the Login field.</p> <div data-bbox="531 1153 1219 1536"> <p>Device administration</p> <hr/> <p>Login</p> <div data-bbox="668 1258 1080 1429"> <p>Login</p> <p>Enter password</p> <hr/> <p>CANCEL OK</p> </div> </div> <p>Use the virtual keyboard displayed to enter the password (1234 or 1111). Note that the virtual keypad pops up for all 'Settings' fields to allow inputting characters and / or numbers. Two virtual keyboard types can be displayed: Numeric (shown first below) or QWERTY (shown second below).</p>

Setting	Description
	<div data-bbox="531 264 1401 748"> </div> <div data-bbox="531 779 1401 1263"> </div> <p data-bbox="523 1301 1393 1413">These virtual keyboards are also displayed when network administrators need to enter an IP address to debug, or when they need to enter their PIN lock for the security tab.</p>
<p>Modify network</p>	<p>Enables the Admin user to determine network information and to modify network settings.</p> <div data-bbox="531 1536 1219 1917"> </div>

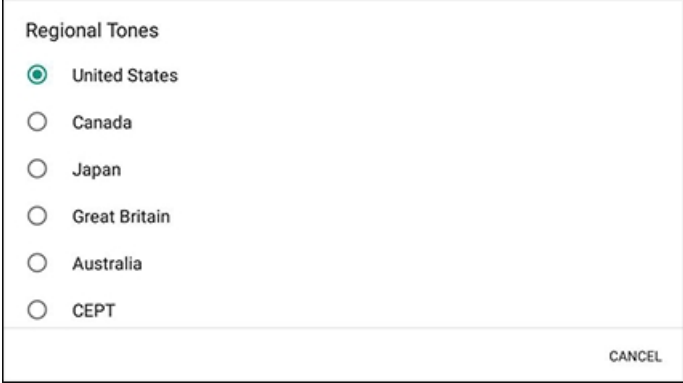
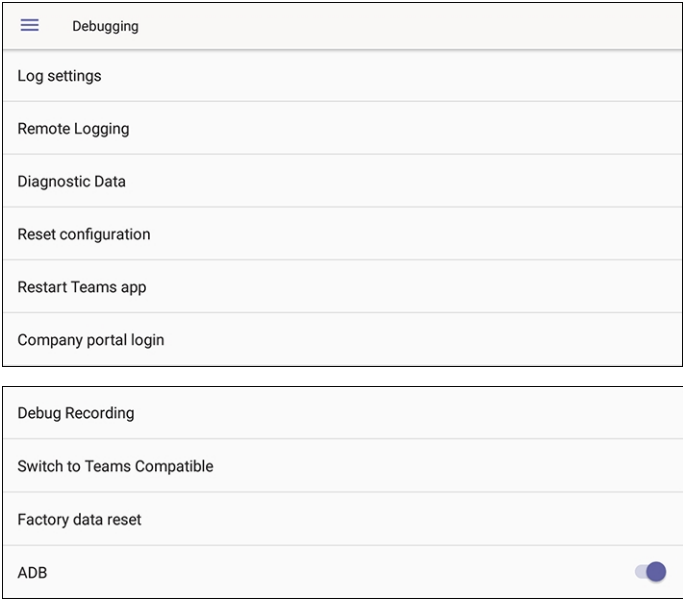
Setting	Description
	 <p>IP Address [Read Only] IP Settings [DHCP or Static IP] Network state [Read Only] Enable PC port Proxy 802.1x Settings VLAN Settings. Allows you to configure the VLAN mode Manual, CDP only or LLDP only.</p>
Proxy	<p>The phone can be configured with an HTTP Proxy server by an Admin user in two ways:</p> <ul style="list-style-type: none"> ■ Manually. The Admin user can use this method to configure HTTP proxy server parameters through the Teams application: <ol style="list-style-type: none"> a. Log in to 'Device administration': 


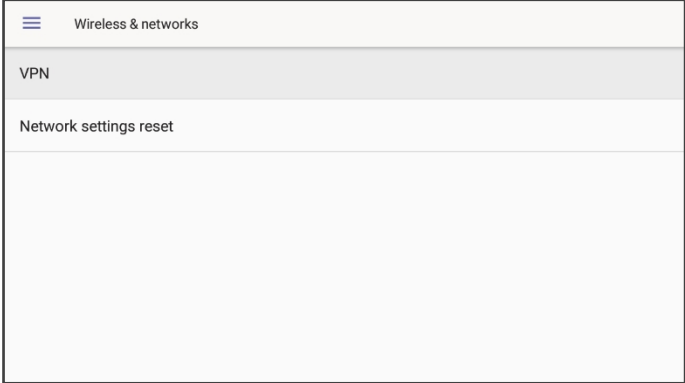
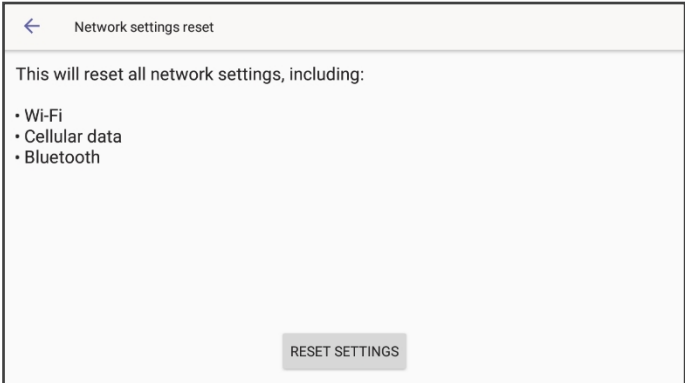
Setting	Description
	<div data-bbox="572 264 1230 629" style="border: 1px solid black; padding: 5px; margin-bottom: 10px;">  </div> <p data-bbox="572 667 1050 698">b. Touch the Modify network option:</p> <div data-bbox="572 719 1272 1106" style="border: 1px solid black; padding: 5px; margin-bottom: 10px;">  </div> <div data-bbox="572 1126 1272 1514" style="border: 1px solid black; padding: 5px;">  </div> <p data-bbox="572 1552 1326 1621">c. Touch the Proxy option and then configure the proxy host name and port:</p>

Setting	Description										
	 <p>← Settings</p> <p>Proxy hostname 10.13.2.25</p> <p>Proxy port 3128</p> <p>Bypass proxy for</p> <p>DONE CLEAR RESTORE DEFAULTS</p> <p>■ Over DHCP with Option 252. It's recommended that the Admin user uses this method when provisioning multiple phones. Option 252 provides a DHCP client with a URL to use to configure its proxy settings:</p>  <p>Reservation Options</p> <p>General Advanced</p> <table border="1"> <thead> <tr> <th>Available Options</th> <th>Description</th> </tr> </thead> <tbody> <tr> <td><input type="checkbox"/> 120 UCSipServer</td> <td>Sip Server F</td> </tr> <tr> <td><input type="checkbox"/> 121 Classless Static Routes</td> <td>Destination,</td> </tr> <tr> <td><input type="checkbox"/> 160 Audiocodes 160 Option</td> <td>Audiocodes</td> </tr> <tr> <td><input checked="" type="checkbox"/> 252 wpad-url</td> <td></td> </tr> </tbody> </table> <p>Data entry</p> <p>String value: http://10.37.4.99/proxy.pac</p> <p>OK Cancel Apply</p> <p>The proxy setting is provided in a Proxy Auto-Configuration (PAC) file that contains a set of rules coded in JavaScript which allows a web browser to determine whether to send web traffic directly to the Internet or to be sent via a proxy server. PAC files control how the phone handles HTTP, HTTPS and FTP traffic.</p> <p>Example of a basic PAC file:</p> <pre>function FindProxyForURL(url, host) { return "PROXY 10.13.2.40:3128";</pre>	Available Options	Description	<input type="checkbox"/> 120 UCSipServer	Sip Server F	<input type="checkbox"/> 121 Classless Static Routes	Destination,	<input type="checkbox"/> 160 Audiocodes 160 Option	Audiocodes	<input checked="" type="checkbox"/> 252 wpad-url	
Available Options	Description										
<input type="checkbox"/> 120 UCSipServer	Sip Server F										
<input type="checkbox"/> 121 Classless Static Routes	Destination,										
<input type="checkbox"/> 160 Audiocodes 160 Option	Audiocodes										
<input checked="" type="checkbox"/> 252 wpad-url											

Setting	Description
<p>802.1x Settings</p>	<p data-bbox="571 264 587 297">}</p> <p data-bbox="528 338 1394 528">802.1X Authentication is the IEEE Standard for Port-based Network Access Control (PNAC). See https://1.ieee802.org/security/802-1x/ for more information. In Version 1.2.196, 802.1X Authentication is supported for MD5 only. Support for EAP-TLS will be added in the next release.</p> <p data-bbox="528 546 1394 613">In the 'Modify Network' screen (as an Admin), access the 802.1x Settings screen.</p> <div data-bbox="528 624 1106 949" style="border: 1px solid black; padding: 5px;">  </div> <p data-bbox="520 987 1023 1021">To configure EAP-MD5 mode for 802.1X:</p> <ol data-bbox="520 1043 1050 1308" style="list-style-type: none"> 1. Set the EAP method to the MD5 option. 2. Enter this information: <ul style="list-style-type: none"> ✓ Identity: User ID ✓ Password: MD5 password (optional) 3. Touch the Save softkey.
<p>VLAN Settings</p>	<p data-bbox="528 1346 1002 1379">Touch the menu option VLAN Settings.</p> <div data-bbox="528 1386 1217 1771" style="border: 1px solid black; padding: 5px;">  </div> <p data-bbox="520 1805 884 1839">Touch VLAN Discovery mode.</p>

Setting	Description
	<div data-bbox="531 264 1217 645" style="border: 1px solid black; padding: 5px; margin-bottom: 10px;"> <p>VLAN Discovery mode</p> <p><input type="radio"/> Disabled</p> <p><input type="radio"/> Manual configuration</p> <p><input type="radio"/> Automatic configuration (CDP)</p> <p><input type="radio"/> Automatic configuration (LLDP)</p> <p><input checked="" type="radio"/> Automatic configuration (CDP+LLDP)</p> <p style="text-align: right;">CANCEL OK</p> </div> <p>■ Cisco Discovery Protocol (CDP) is a Cisco proprietary Data Link Layer protocol</p> <p>■ Link Layer Discovery Protocol (LLDP) is a standard, layer two discovery protocol</p> <p>Select the mode you require and then touch OK. If you select Manual configuration, this screen opens:</p> <div data-bbox="523 969 1209 1350" style="border: 1px solid black; padding: 5px; margin-top: 10px;"> <p>← Settings</p> <hr/> <p>VLAN Discovery mode Manual configuration</p> <hr/> <p>VLAN ID -1</p> <hr/> <p>VLAN Priority 1</p> <hr/> </div>
<p>Regional preference</p>	<p>Touch the menu option Regional preference.</p> <div data-bbox="531 1440 1217 1821" style="border: 1px solid black; padding: 5px; margin-bottom: 10px;"> <p>☰ Region preference</p> <hr/> <p>Regional Tone Settings United States</p> <hr/> </div> <p>This option allows you to define the country in which the phone is located. The setting determines which regional tone the phone will use. Call Progress Tones (CPTs) are country-specific; the behavior and</p>

Setting	Description
	<p>parameters of analog telephones lines vary from country to country. Touch Regional Tone Settings and select the country in which the phone is located.</p>  <p>The screenshot shows a 'Regional Tones' menu with the following options: United States (selected), Canada, Japan, Great Britain, Australia, and CEPT. A 'CANCEL' button is at the bottom right.</p>
<p>Debugging</p>	<p>Allows the Admin user to perform debugging for troubleshooting purposes. Available after logging in as Admin.</p>  <p>The screenshot shows a 'Debugging' menu with the following options: Log settings, Remote Logging, Diagnostic Data, Reset configuration, Restart Teams app, and Company portal login. Below this is a 'Debug Recording' section with 'Switch to Teams Compatible', 'Factory data reset', and 'ADB' (with a toggle switch).</p> <p>Log settings Remote Logging (see under Remote Logging on page 71 for more information) Diagnostic Data (see under Diagnostic Data on page 72 for more information) Reset configuration Restart Teams app Company portal login Debug Recording (for Media/DSP debugging) (see under Remote Logging on page 71 for more information)</p>

Setting	Description
	<p>Switch to Teams Compatible</p> <p>Factory data reset (the equivalent of restore to defaults; including logout and device reboot).</p> <p>ADB (Android Debug Bridge command-line tool used to debug the Teams app); the setting is disabled by default; leave it unchanged at the default unless there's a real necessity to use it.</p>
<p>Backup & Reset</p>	<p>Enables the Admin user to perform a factory data reset.</p> 
<p>... More</p>	<p>Enables the Admin user to access the Wireless & Networks screen.</p>  <p>The 'Network settings reset' options enables resetting all network settings including Wi-Fi, Cellular data and Bluetooth. (Note that Bluetooth is currently supported at a Beta level).</p> 

Restoring the Phone to Default Settings

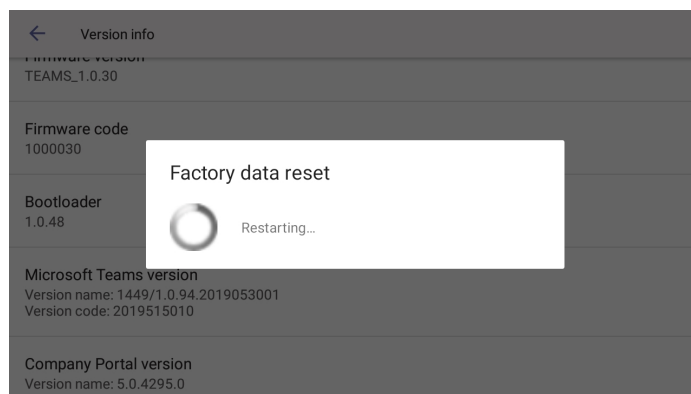
Users can restore the device to factory default settings at any time. The feature can be used if a user forgets their Admin password, for example. Two kinds of restore are available:

- Hard restore
- Soft restore

Performing a Hard Restore

➤ **To perform a hard restore:**

1. Long-press the HOLD key on the phone (more than 15 seconds); you're prompted with the next screen and the device performs a restore to default factory settings.



After the restore, the phone automatically reboots and goes through the Wizard and sign-in process.

2. Touch **OK**; the sign-in screen is displayed (see [Signing In](#) on page 35 for more information).

Performing a Soft Restore

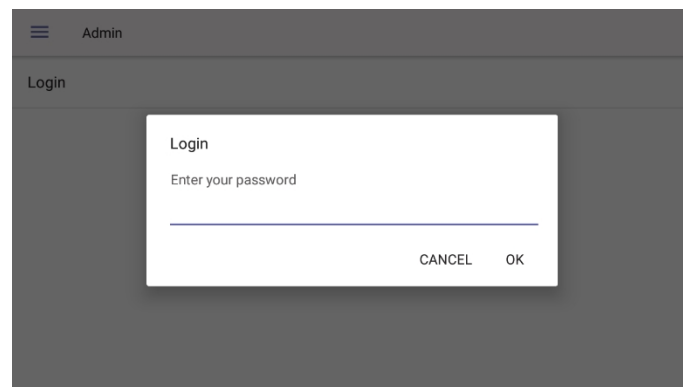
Users must log in as Administrator in order to perform a soft restore. The soft restore is then performed in the 'Debug' screen.

➤ **To perform a soft restore:**

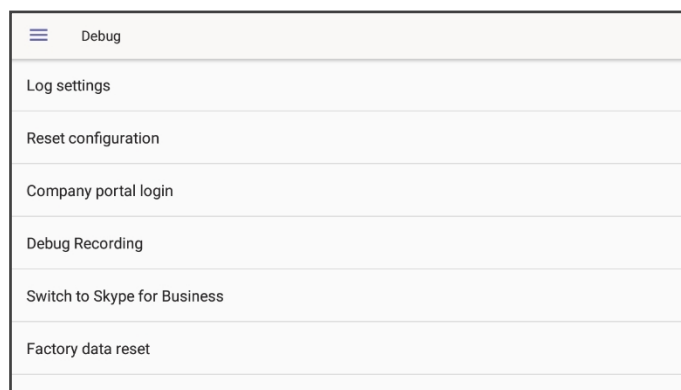
1. Press the MENU key on the phone and in the Settings screen that opens, scroll down and touch the **Admin** option.



2. Touch the **Login** menu item.



3. Touch the field for the virtual keyboard to be displayed and then enter the default password of **1234**; you're prompted with 'You are now logged in'; you now have privileges to configure the Device Settings screen.
4. Press the **x** key on the phone to go back and then in the (device) Settings screen, select the **Debug** option.



5. Touch the **Factory data reset** option; the device performs a restore to default factory settings.

Locking and Unlocking the Phone

As a security precaution, the phone can be locked and unlocked. The feature includes:

- Smart unlock (see [Smart Unlock](#) on the next page)

- Automatic lock ([Automatic Lock](#) below)

Automatic Lock

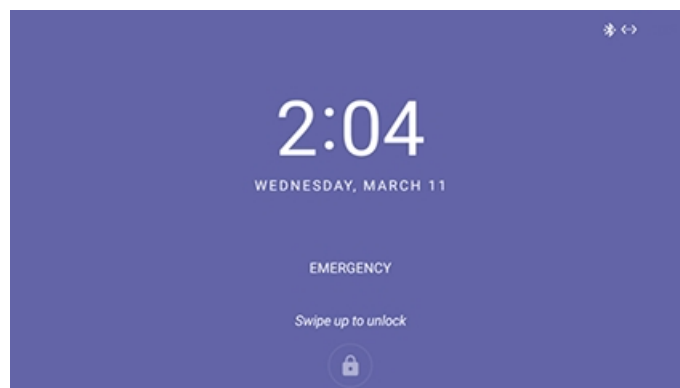
Users can lock their phones as a security precaution. Make sure the phone is configured with any of the lock options before attempting to lock it. If a lock option isn't configured, the lock action won't work.

➤ To lock the phone:

- Press the 'back' hard key for at least three seconds for the device to automatically lock.

Smart Unlock

The smart unlock feature is available for the PIN code lock option. When the phone displays a lock screen as shown in the figure below, the user does not need to swipe to unlock the phone.

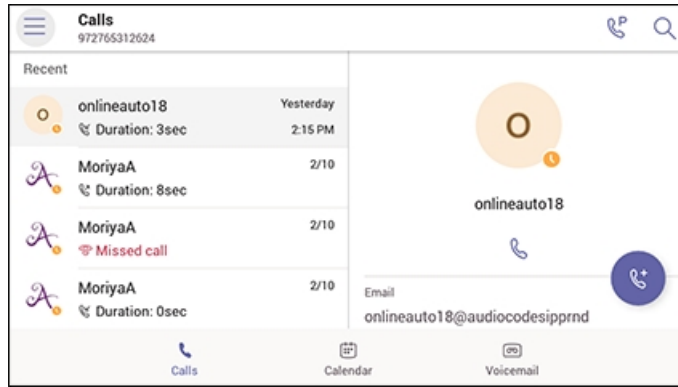


➤ To unlock the phone without swiping:

1. Start typing your unlock PIN code; the phone displays the digits as you type:



2. When the phone detects the unlock code, it unlocks.



4 Teams Application

The documentation following describes functions related to the C450HD phone's Microsoft Teams application.

Signing In



Using TeamsIPPhonePolicy, network administrators can create the following users who can then sign in to the phone:

- UserSignIn: All features are available, i.e., calls, meetings and voicemail
- MeetingSignIn: Only meetings are available
- Common Area Phone (CAP) users who can sign in to the device with a CAP account (as a CAP user) using TeamsIPPhonePolicy as follows:
 - ✓ CAP SignIn (SearchOnCommonAreaPhoneMode=Enabled): The user has calling and searching capability
 - ✓ CAP SignIn (SearchOnCommonAreaPhoneMode=Disabled): The user has calling capability

Before using the phone (after setting it up), you need to sign in for security purposes. You can sign-in with user credentials locally on your IP phone, or remotely with your PC / smart phone.

'Modern Authentication' is also supported.

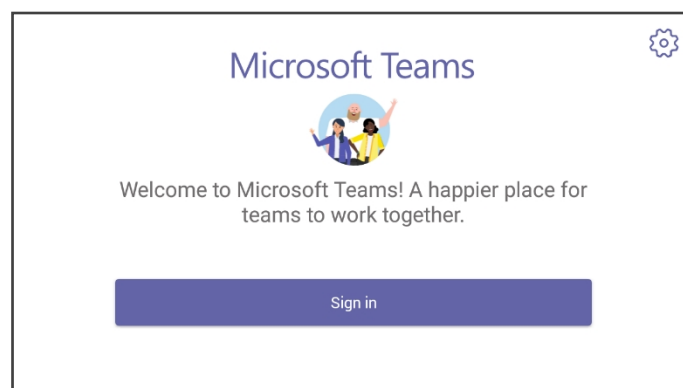
Before signing in, the network administrator must make sure the phone gets the local time, using either:

- Google NTP
- DHCP Option 42 (NTP)

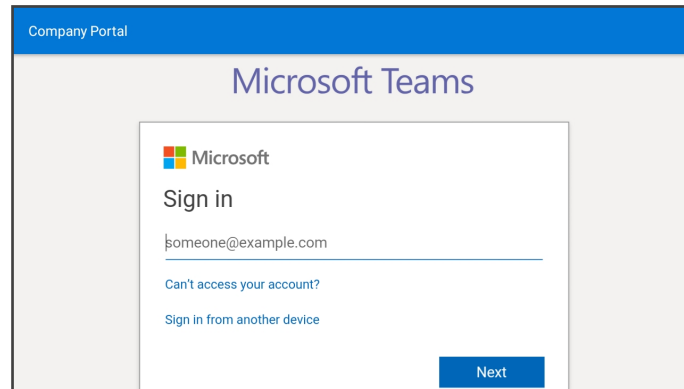
If DHCP Option 42 (NTP) is opted for, the network administrator must specify the server providing NTP for the network.

➤ To sign in:

1. Click the **Sign in** button in the Welcome to Microsoft Teams screen.

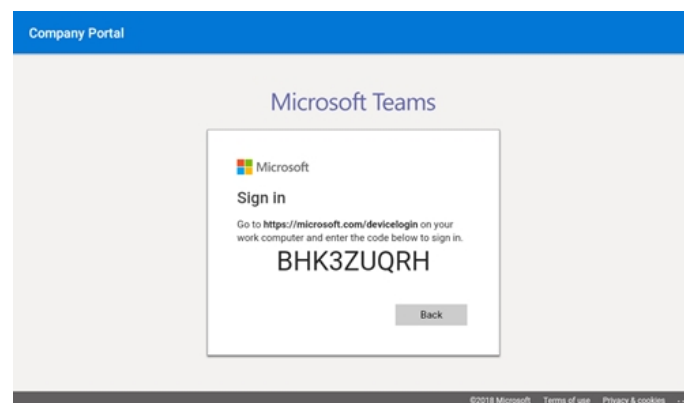


You're prompted with the option to sign in by entering user credentials (someone@example.com as can be seen in the following example), or **Sign in from another device**.



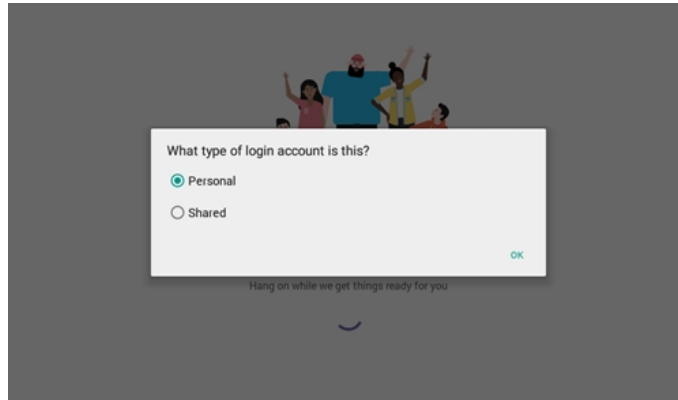
- If you opt to sign in with user credentials and you touch the someone@example.com field, the keyboard that opens eclipses the field; scroll up to view it and enter your user credentials.
- If you opt to **Sign in from another device**, complete authentication from your PC or smartphone. This is recommended if you're using Multi Factor Authentication (MFA).

Figure 4-1: Signing-in via PC / Smart Phone



- ◆ In the browser on your PC or smartphone, enter the URL indicated in the preceding screen and then in the phone's Web interface that opens, perform sign-in (as noted previously, this option is recommended if using MFA).
- After successful sign-in, select **Personal** use or **Shared**.

Figure 4-2: Personal or Shared



User experience is optimized based on the selection.

Figure 4-3: Personal Mode

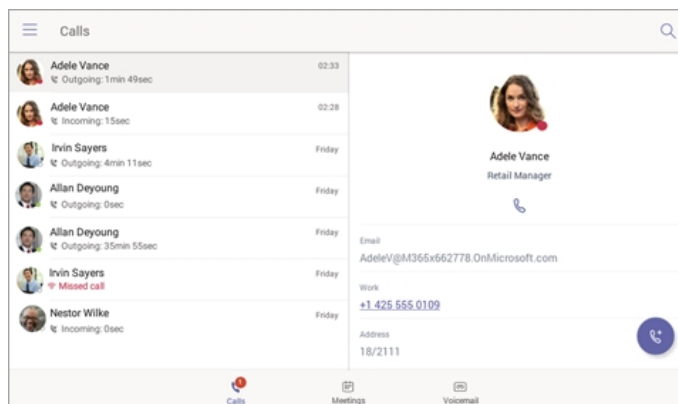
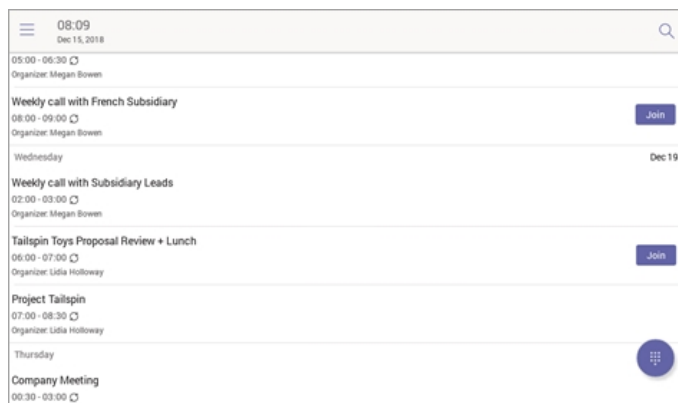


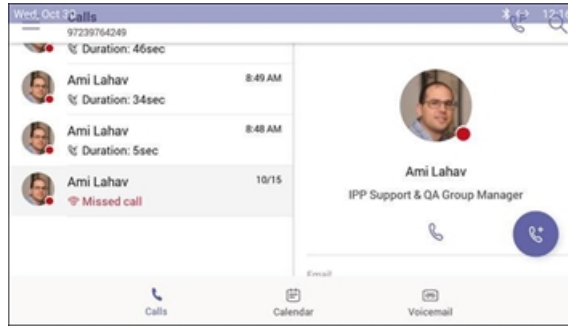
Figure 4-4: Shared Mode



Getting Acquainted with the Phone Screen

The documentation following gets you acquainted with the phone's user interface. The next figure shows the screen when the phone is in idle state.

Figure 4-5: Phone Screen in Idle State - Calls



Use this table as reference.

Table 4-1: Phone Screen in Idle State - Description


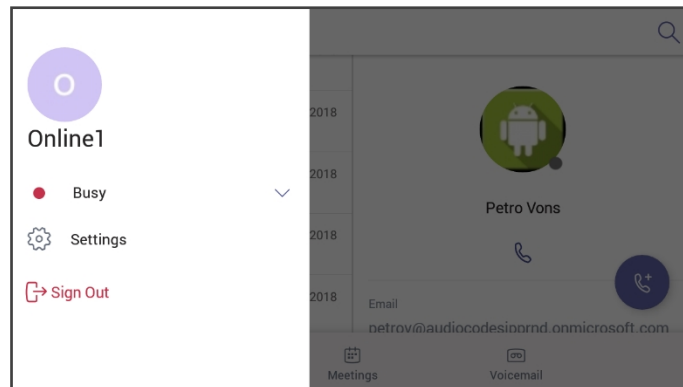
Item	Description
	The phone menu. Touch to open. The screen shown after this table opens.
Calls	Touch the tab to open the Calls screen if isn't already (i.e., if the Meetings screen or Voicemail screen is open). The screen shown in the figure preceding this table opens.
Meetings	Touch the tab to open the Meetings screen, shown under Setting up a Meeting on page 44 opens.
Voicemail	Touch the tab to open the Voicemail screen, shown under Accessing Voicemail on page 47 opens.

Figure 4-6: Phone Screen in Idle State - Menu Items




Use this table as reference.

Table 4-2: Menu Item Descriptions

Item	Description
Presence status	See Changing Presence Status below for more information.
Settings	See Configuring Teams Application Settings on page 41 for more information.
Sign Out	See Signing Out on page 48 for more information.

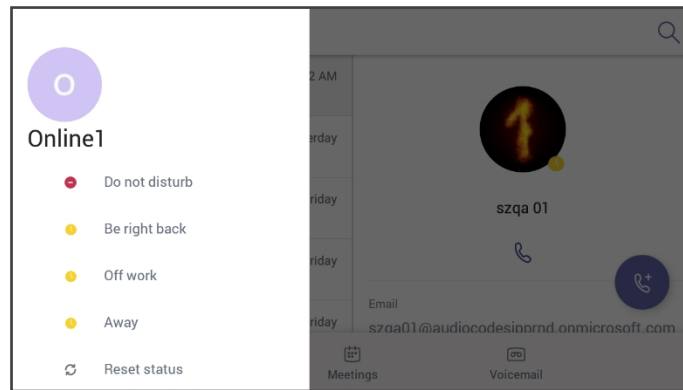
Changing Presence Status

You can assign a presence status to control whether you want people to contact you or not. By default, your status is based on your Teams server.

 • After *n* minutes (configured in the Teams server by your administrator), presence status automatically changes to 'Inactive'.







• *n* minutes after this (also configured in the Teams server by your administrator), presence status automatically changes to 'Away'; all calls are then automatically forwarded to the RGS (Response Group Service) if it is configured.

From the drop-down list in the phone's idle screen, select the status you require.



Use this table as reference.

Table 4-3: Presence Statuses

Icon	Presence Status	Description
	Available	You're online and available for other contacts to call.
	Busy	You're busy and don't want to be interrupted.
	Do not disturb	You don't want to be disturbed. Stops the phone from ringing when others call you. If DnD is activated, callers hear a tone indicating that your phone is busy; the call is blocked and your phone's touch screen indicates 'Missed Calls'.
	Be Right Back	You'll be away briefly and you'll return shortly.
	Off Work	You're going on vacation (for example).
	Away	You want to hide your status and appear to others you're currently away.

Configuring Teams Application Settings


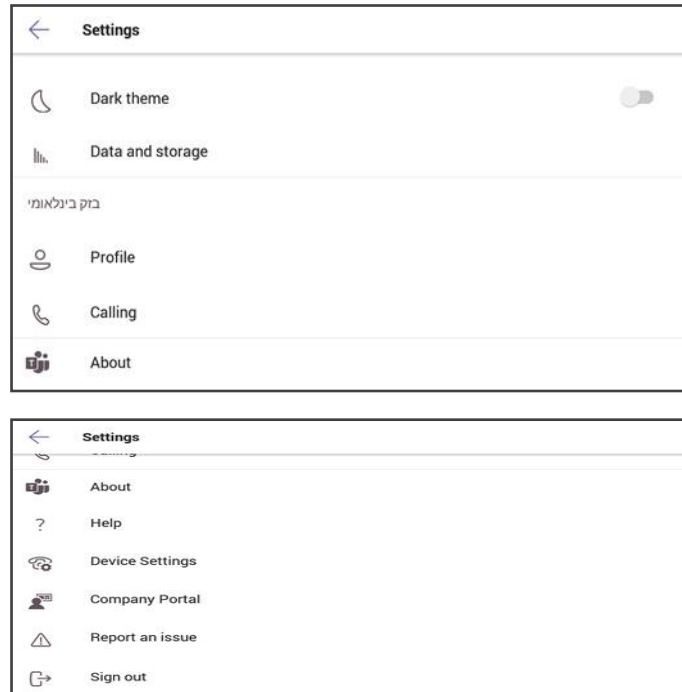
The documentation here describes Teams application settings. In the Calls screen, touch the phone menu  and from the menu screen shown previously, select the **Settings** item.

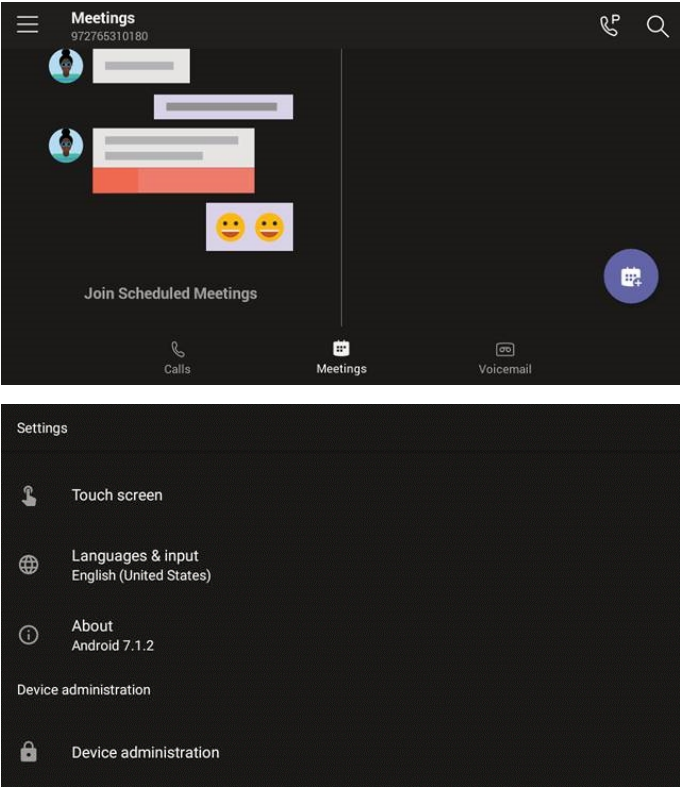
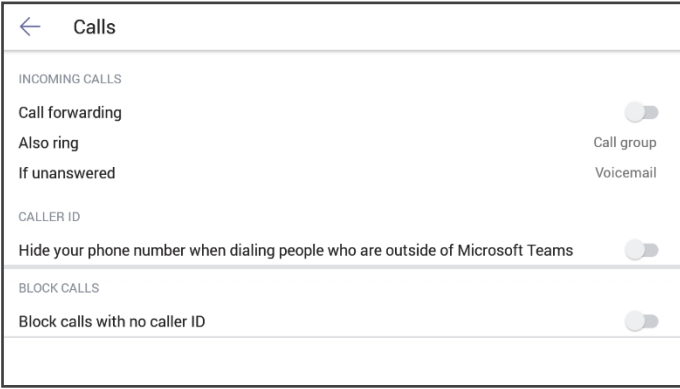
Figure 4-7: Settings

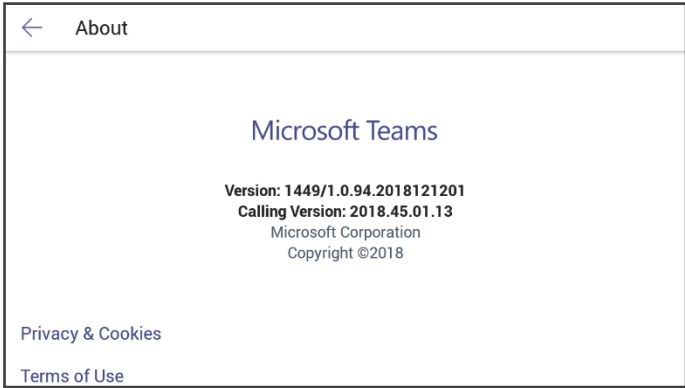
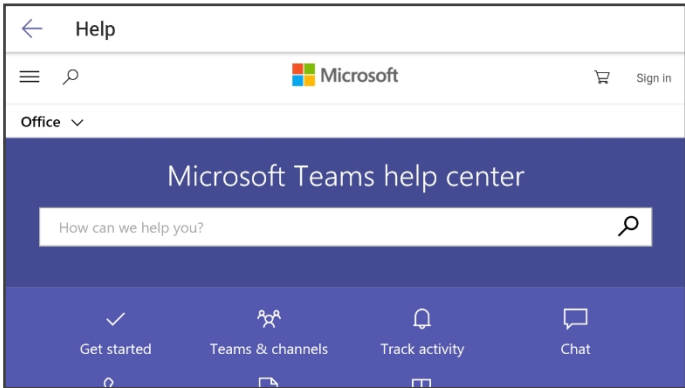


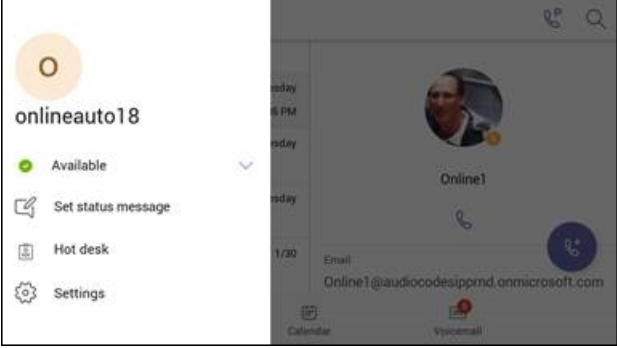
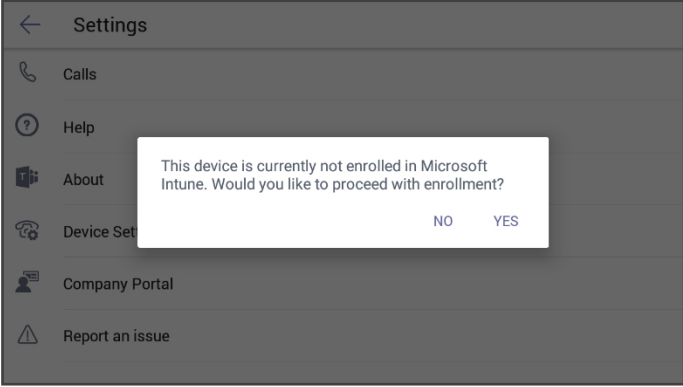
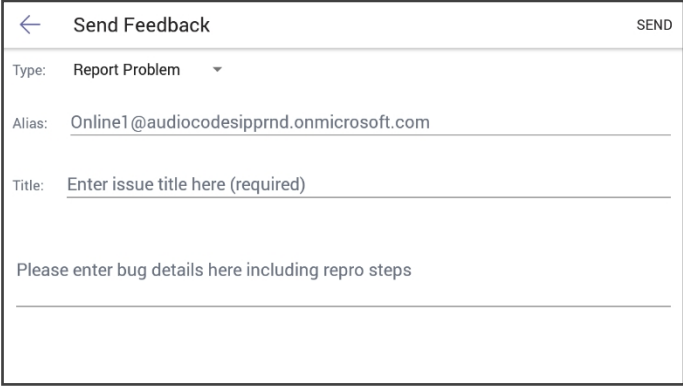
Use this table as reference:

Table 4-4: Idle Screen Description

Item	Description
Dark Theme	<p>Dark Theme can be enabled to suit user preference.</p> <p>To enable Dark Theme:</p> <ol style="list-style-type: none"> 1. Drag the 'Dark Theme' setting slider to the 'on' position; the following prompt is displayed: <div data-bbox="470 1536 1155 1917" data-label="Image"> </div> 2. Click Restart and then verify after the Teams application restarts that all

Item	Description
	<p>screens (Teams application and Device Settings) are dark themed as in the following examples:</p> 
<p>Calling</p>	<p>Opens the Calls screen.</p>  <p>Incoming Calls</p> <ul style="list-style-type: none"> ■ Call forwarding. Enables automatically redirecting an incoming call to another destination. ■ Forward to. Only displayed if the previous setting is enabled. Defines the destination to which to forward incoming calls. ■ Also ring. Only displayed if 'Call forwarding' is disabled. Select either Off, Contact or number, or Call group. ■ If unanswered. Only displayed if 'Call forwarding' is disabled. Defines the

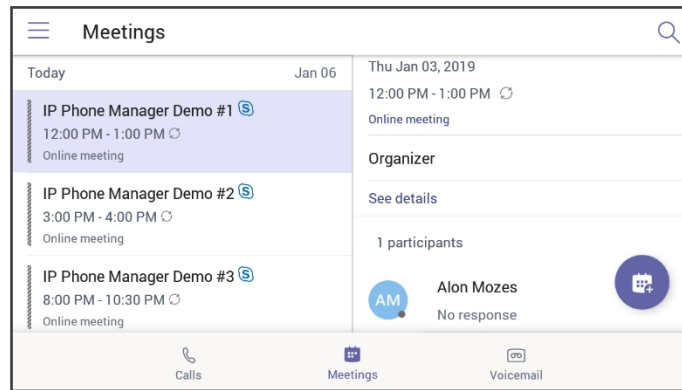
Item	Description
	<p>destination to which to forward unanswered incoming calls. Select either Off, Voicemail, Contact or number, or Call group.</p> <p>Caller ID</p> <ul style="list-style-type: none"> ■ Hide your phone number when dialing people who are outside of Microsoft Teams <p>Block Calls</p> <p>Block calls with no caller ID. Enables blocking calls that do not have a Caller ID.</p>
<p>About</p>	<p>Opens the About screen.</p> 
<p>Help</p>	<p>Opens the 'Microsoft Teams help center' screen.</p>  <ul style="list-style-type: none"> ■ Get started ■ Teams & channels ■ Track activity ■ Chat ■ Meetings & calls ■ Files ■ Apps & services
<p>Device Settings</p>	<p>Opens the [Device] Settings screen.</p>

Item	Description
<p>Hot Desking</p>	<p>Allows signing in to a phone that is already signed in by another user without signing out the original user to whom the phone was assigned for primary use. Access the Hot Desking feature from the Hot desk option in the Teams application settings.</p> 
<p>Company Portal</p>	<p>The phone is by default not enrolled. You're prompted with the option to enroll:</p> 
<p>Report an issue</p>	<p>Opens the Send Feedback screen.</p> 

Setting up a Meeting

Touch the **Meetings** tab to view your meetings. Use the **Join** button to join your Teams meetings.

Figure 4-8: Meetings



Select the **Join** button to join your Teams meetings.

Figure 4-9: Calendar view

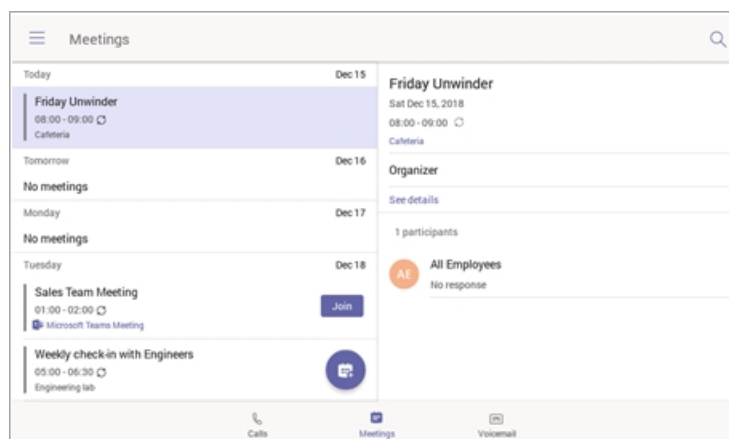
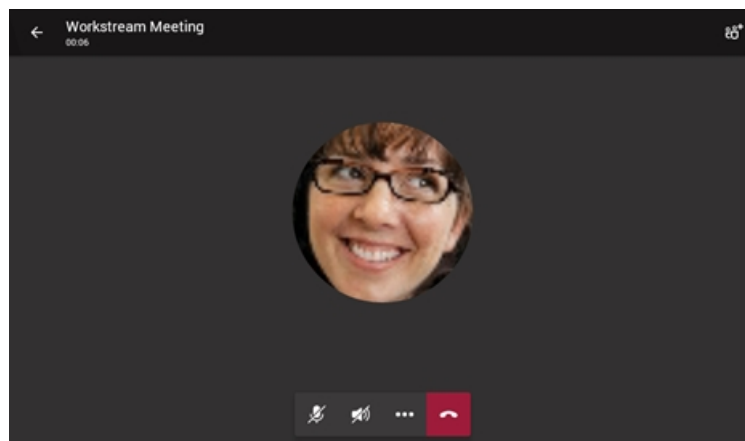


Figure 4-10: Meeting join view



Using the People App

The People app allows the user to easily connect and collaborate with teammates, colleagues, friends and family. Through the app, the user can see all their contacts and create and manage contact groups to organize their contacts. The app also provides a simple user experience and aligns with the contacts on the Teams desktop client. Note that in addition to accessing the

People screen from the menu, the screen can also be accessed from the hard CONTACTS button on the phone.

Figure 4-11: Accessing the People app

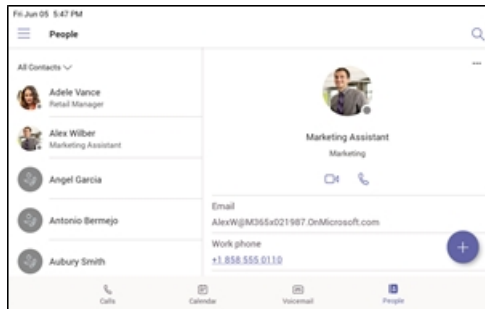


Figure 4-12: Creating new group

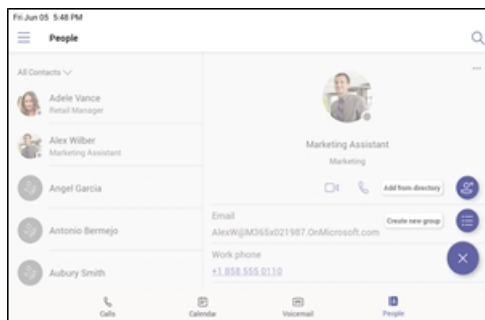


Figure 4-13: Add from directory



Figure 4-14: Select a group



Figure 4-15: Select a group

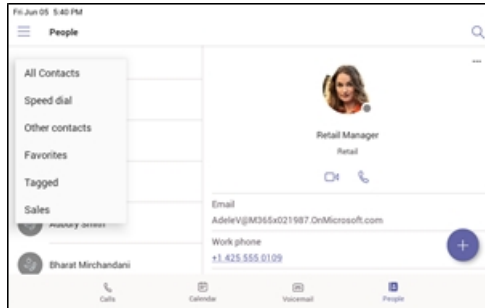
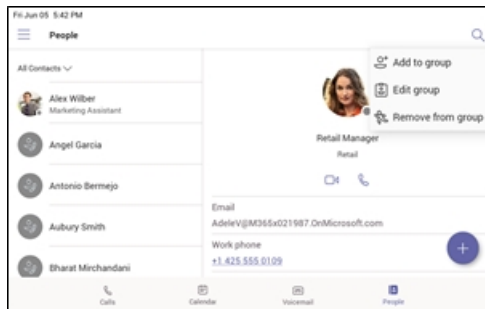


Figure 4-16: Edit group



Accessing Voicemail

You can access your voicemail by touching the **Voicemail** tab.

Figure 4-17: Voicemail

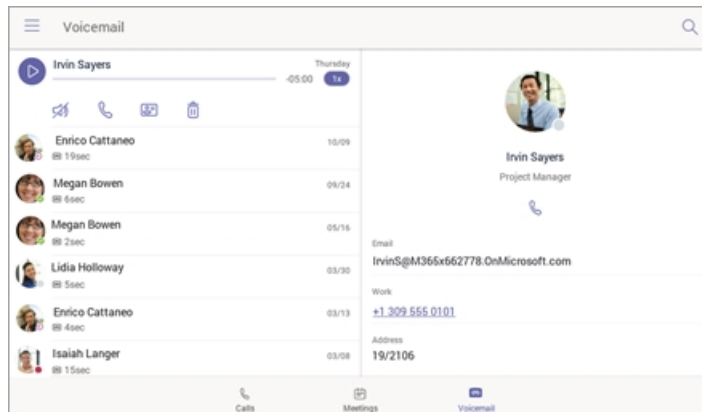
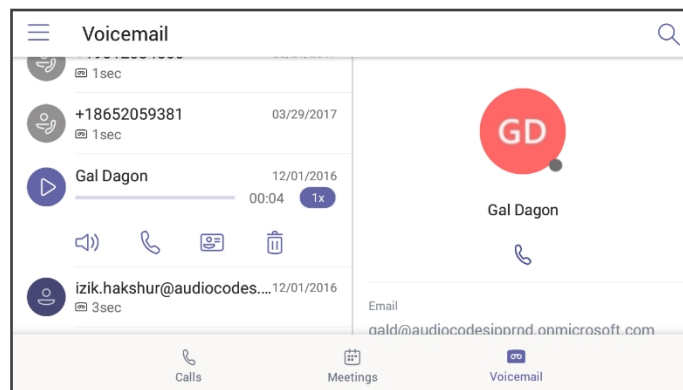


Figure 4-18: Voicemail



Using Audio Devices

You can use one of the following audio devices on the phone for speaking and listening:

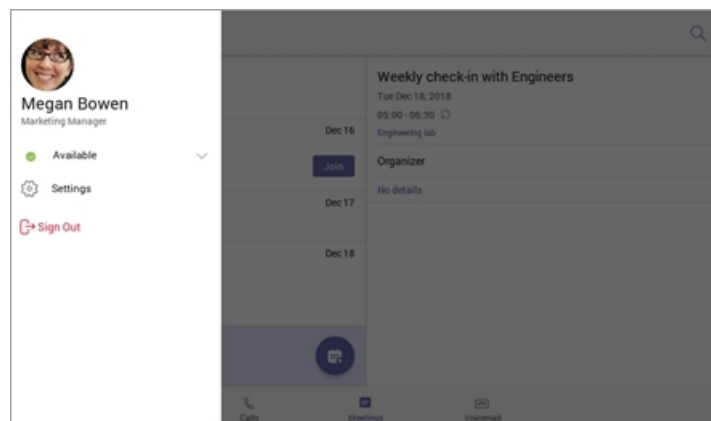
- **Handset:** To make a call or answer a call, lift the handset off the cradle.
- **Speaker** (hands-free mode). To activate it, press the speaker key during a call or when making a call. To deactivate it, press the speaker key again.
- **Headset** (hands-free mode). When talking on the phone, you can relay audio to a connected headset. To enable it, press the headset key. To disable it, press it again.

You can easily change audio device during a call.

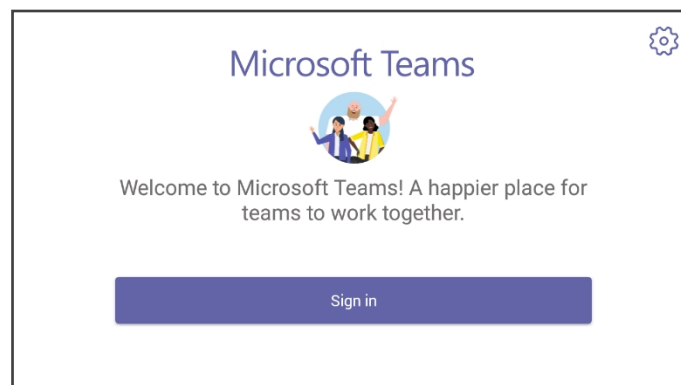
- **To change from speaker/headset to handset:** Activate speaker/headset and pick up the handset; the speaker/headset is automatically disabled.
- **To change from handset to speaker/headset:** Off-hook the handset and press the speaker/headset key to activate the speaker/headset. Return the handset to the cradle; the speaker/headset remains activated.

Signing Out

In the idle screen, touch the phone menu  and then touch the **Sign Out** option.



You're signed out and returned to the **Sign in** screen.

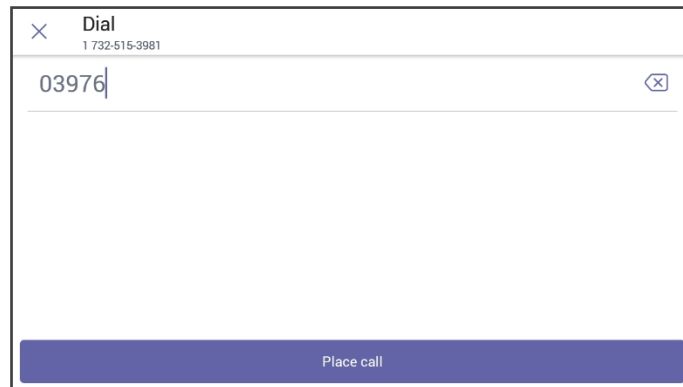



5 Performing Basic Operations

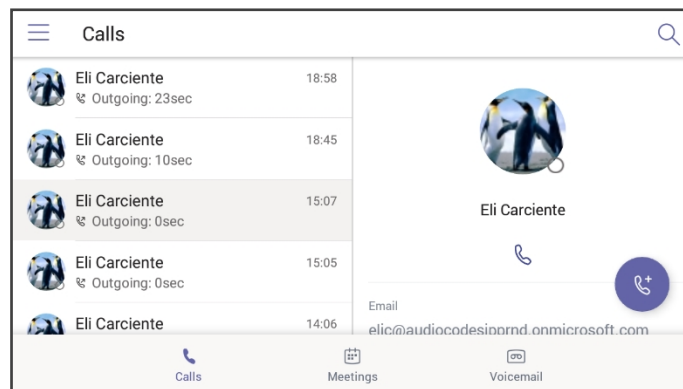
The documentation following shows basic phone operations.


Making a Call

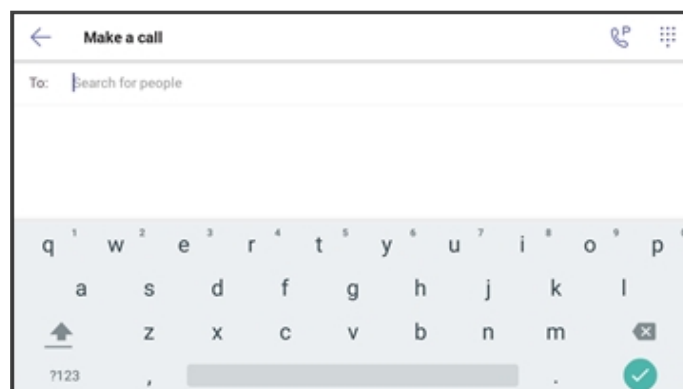
Calls can be made in multiple ways, for example, you can press the digit keys on the phone's dial pad to enter the phone number or URL.



Alternatively, select a call listed in the Calls screen, and then touch .





Touching  in the Calls screen allows you to make a call by entering the name of a contact.



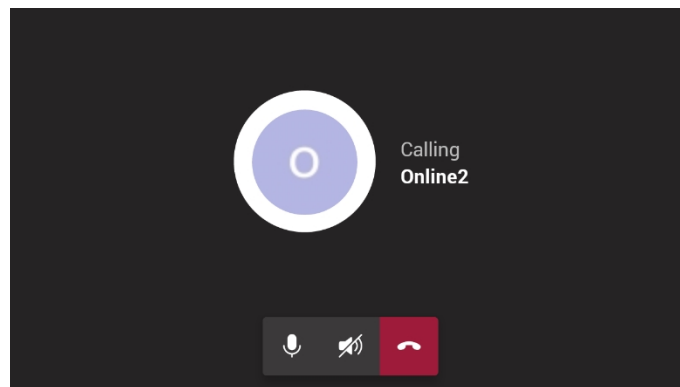


- You need to touch the 'To: Search for people' field to launch the soft keyboard.
- If you decide to nonetheless dial a destination number rather than the name of a contact, touch **?123** in the lower left corner of the screen.

Touching  located in the upper right corner of the screen shown in the preceding figure results in the phone activating the speaker, playing a dial tone and allowing the user to dial digits to make a call.

Touching  located in the upper right corner of the screen shown in the preceding figure allows you to park a call. For more information about parking calls, see [Parking a Call](#) on page 56.

After dialing a destination number, the phone displays the Calling screen while playing a ring-back tone.



➤ To toggle between mute and unmute

- Touch . Touch it again to revert.

You can mute the microphone of the handset, headset, or speaker during a call so that the other party cannot hear you. While the call is muted you can still hear the other party. Muting calls can also be used during conference calls.

➤ To toggle between device and speaker

- Touch .


➤ To end a call before it's answered at the other end

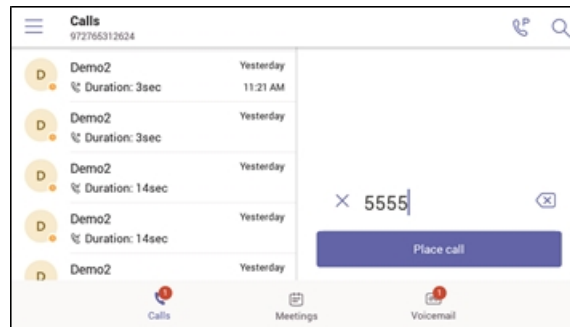
- Touch .

➤ To dial a URL:

1. Press the speaker key or lift the handset and then touch the 'Place call' field.
2. Enter a URL address. To delete (from right to left), touch the clear key.



If after activating the speaker and starting to dial a number you decide you don't want to make the call, touch the  key (shown in the figure below); the speaker LED turns off.



Redialing

You can redial a number you previously dialed.


➤ To redial:

- Press the REDIAL hard key on the phone; the first call listed in the Calls screen redialed.

Dialing a Missed Call

The phone logs all missed calls. The screen in idle state displays the number of missed calls adjacent to the Calls softkey.

➤ To dial a missed call:

1. Touch the Calls softkey and then in the Calls screen navigate to the missed call to dial if there is more than one listed.
2. Scroll down (if necessary) and select the missed call and then touch .

Making an Emergency Call

The phone features an *emergency call service*. The phone's idle lock screen (displayed before the screen that allows entering the PIN code / pattern to unlock the phone) displays an **Emergency** key.



➤ **To dial the service from the locked idle screen either:**

- Touch the **EMERGENCY** softkey shown in the preceding figure of the locked idle screen and then enter the emergency number.



-OR-

- Dial from the locked idle screen without needing to press the **EMERGENCY** key:
 - a. Dial **911**.



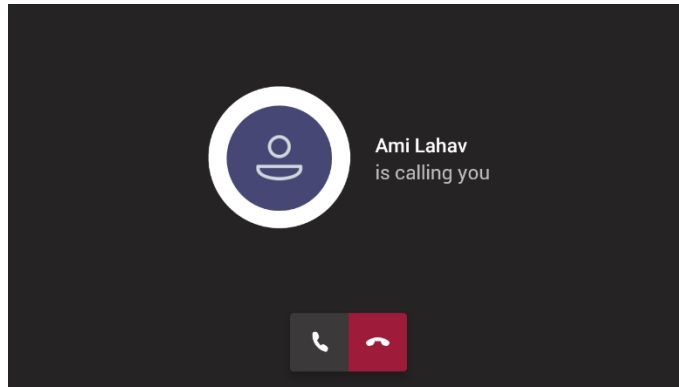
- b. Press the speaker button.
- c. View the 'Emergency call' screen displaying the dialed emergency number.



When the phone detects that 911 was requested, it automatically dials that number.

Answering Calls

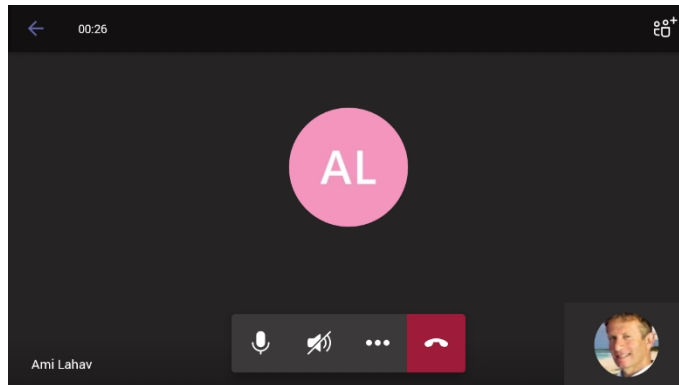
Your phone indicates an incoming call by ringing and displaying this screen:



➤ **To answer:**

- Pick up the handset -OR- press the headset key (make sure the headset is connected to the phone) -OR- press the speaker key -OR- touch the **Accept** softkey (the speaker is automatically activated).

When you answer, the screen displays this screen:



Ending an Established Call

You can end an established call.

➤ To end an established call:

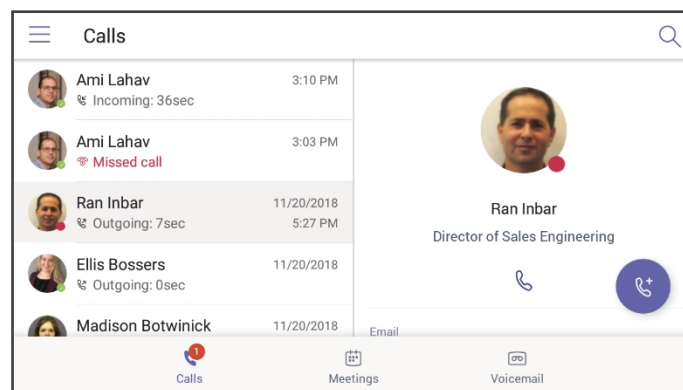
- Return the handset to the phone cradle if it was used to take the call -or- press the headset key -or- press the speaker key -or- touch the **End** softkey.

Managing Calls


The phone's Calls screen displays missed, received and dialed calls.

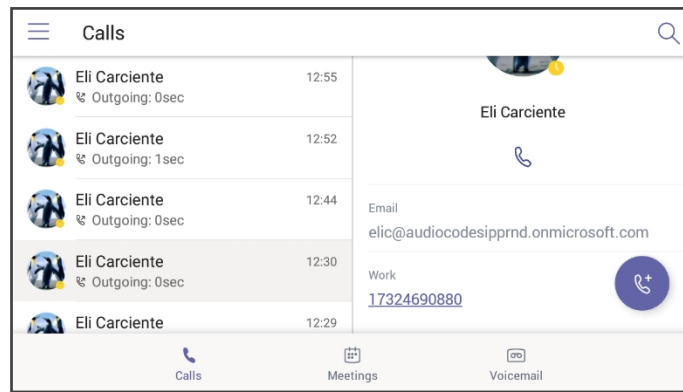
Note: Each device reports every call from | to that user to the server. All devices that a user signs into are synchronized with the server. The Calls screen is synchronized with server.

In idle state, the touch screen displays the number of missed calls (if any). In the following example, 1 missed call is indicated.



➤ To manage calls:

1. Touch the Calls softkey; in the list of historical calls displayed, Missed call indicates a call that was not answered.
 - Incoming = most recently answered
 - Outgoing = most recently dialed
2. Scroll to and select a call in the list; their picture is displayed in the right side of the screen together with their email and work number if defined in the server.
3. Touch  to dial them




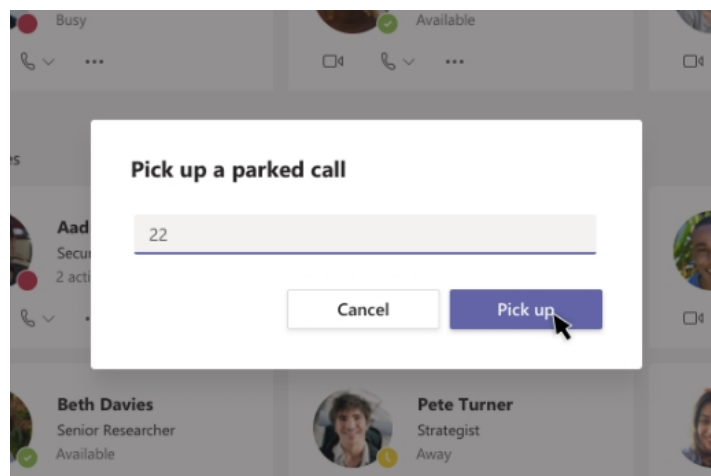
Calls are listed from newest to oldest.

Parking a Call

This Microsoft Teams application feature allows a user to park a call, i.e., transfer a call to a "parking lot" for it to be picked up on any other phone in the enterprise by a party who must enter a code to retrieve it.

➤ To park a call:

1. Put the call on hold and park it; you'll receive a unique code from the Teams application.
2. Communicate the code to another user who can then pick up the call on their device. The user on the other device touches the call park icon  displayed in their device's Calls screen.



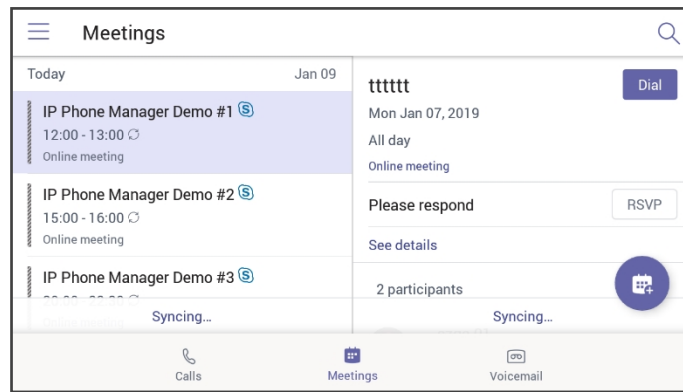
3. The user on the other device enters the code communicated to them and then touches the 'Pick up' button to pick up the call.

Initiating a Teams Meeting

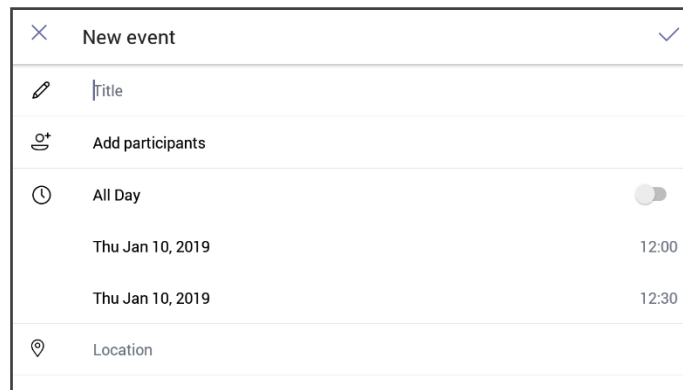
A multi-party call conference based on the Teams server (remote conference) can be initiated from the phone.

➤ To initiate a conference:

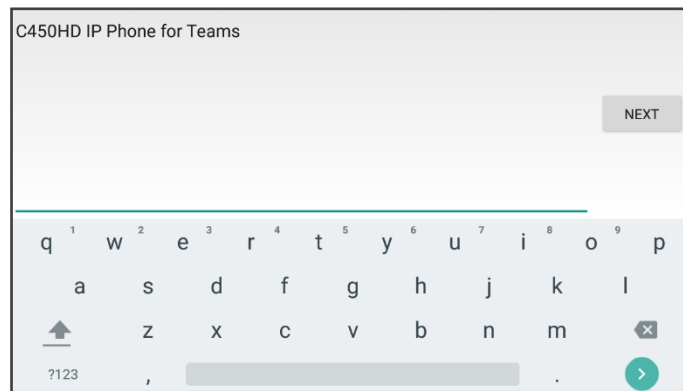
1. In the phone's idle screen, touch the **Meetings** softkey.



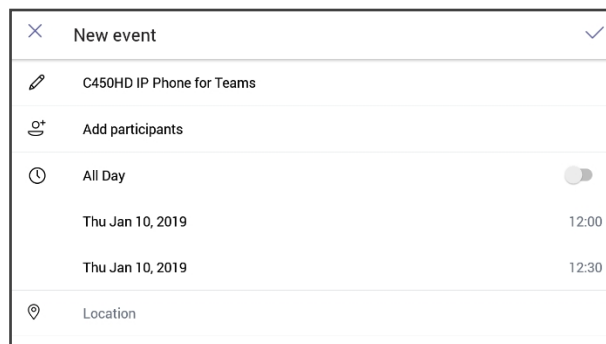
2. Touch the + icon.



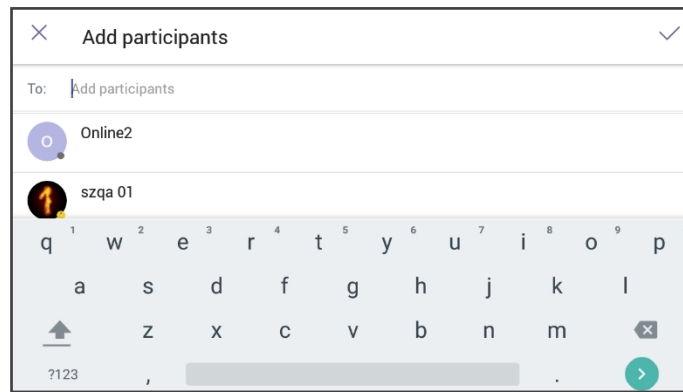
3. Touch the Title field. Use the soft keyboard that launches to enter a title for the meeting.



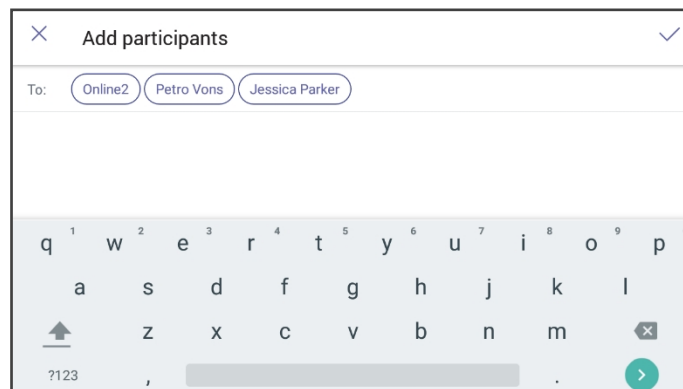
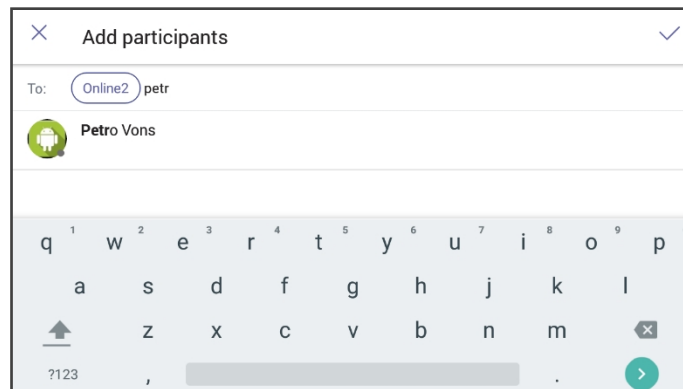
4. Touch NEXT.



5. Touch Add participants.



6. Touch the 'To' field and then use the soft keyboard to enter the first letter of the name of the participant to add. If you're searching for **Alex** (for example), touch the letter **A** on the soft keyboard, then **L**, etc.; the name you're searching for will be promoted to the top of the list of Corporate Directory entries displayed.



The feature lets you quickly and easily navigate to any employee listed in the Corporate Directory.

Using Live Captions

The Teams phone can detect what's said in a meeting or group call and present real-time captions.



Live captions are a preview feature of Microsoft Teams and they're only available in English (US) in version 1.4.

Figure 5-1: Start recording

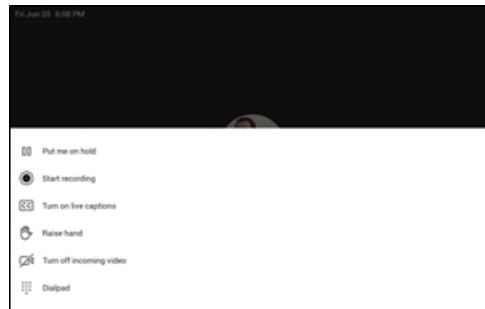
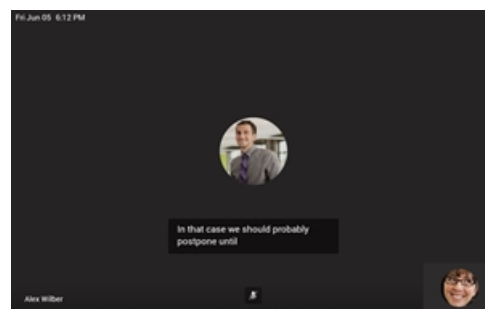


Figure 5-2: Recording



For more information, go to <https://support.microsoft.com/en-us/office/use-live-captions-in-a-teams-meeting-4be2d304-f675-4b57-8347-cbd000a21260#ID0EABAAA=Mobile>

Raising a Hand During a Meeting

During a meeting, you can raise a virtual hand from your phone to let people know you want to contribute without interrupting the conversation. Everyone in the meeting will see that you've got your hand up.

Figure 5-3: Raise hand

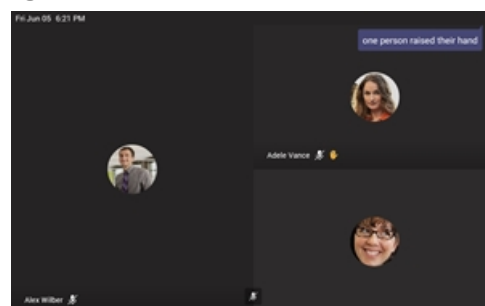
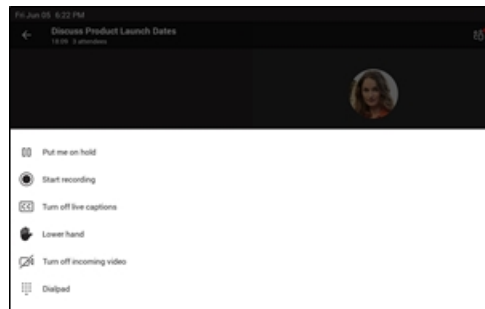
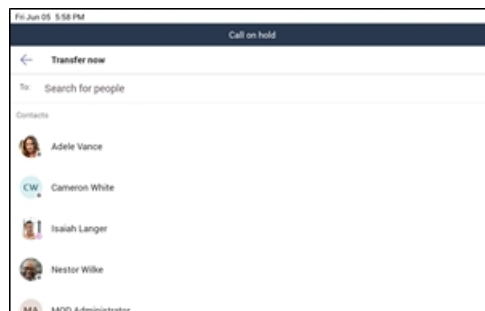


Figure 5-4: Lower hand

For more information, see <https://support.office.com/en-us/article/raise-your-hand-in-a-teams-meeting-bb2dd8e1-e6bd-43a6-85cf-30822667b372>

Transferring a Call to Frequent Contacts

To transfer your calls efficiently to frequent contacts, the phone suggests contacts in the transfer screen for a single touch transfer. Contacts not shown in the list could be searched in the search bar, as always.



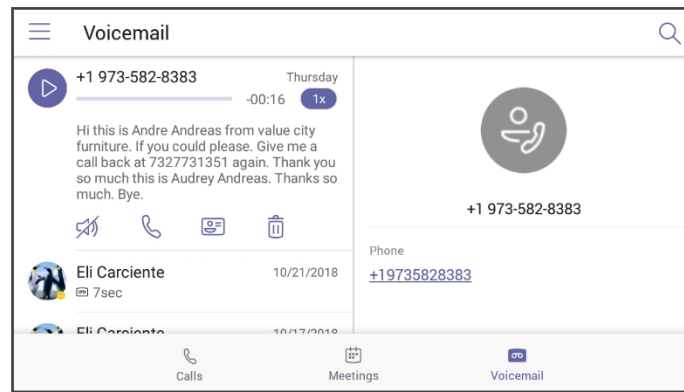
Viewing and Playing Voicemail Messages

New messages will be in your voicemail box if

- the envelope softkey displayed in the phone's screen indicates a number
- a stutter dial tone is heard when you pick up the handset

➤ To view a list of your voicemail messages:

1. Press the voicemail key on the phone (indicated by the icon of an envelope) which will be illuminated if you have voicemail, or touch the Voicemail softkey in the idle screen.




2. Scroll down to select from the list which message to **Play**, **Call** or **Delete**.

Rejecting an Incoming Call, Sending it Directly to Voicemail

You can send an incoming call directly to voicemail if time constraints (for example) prevent you from answering it. The caller hears a busy tone from your phone.

➤ To send an incoming call directly to voicemail:

- When the phone rings to alert to a call, touch ; if you have voicemail, the call will go into voicemail; the Microsoft Teams server performs this functionality.

Adjusting Volume

The phone allows you to adjust

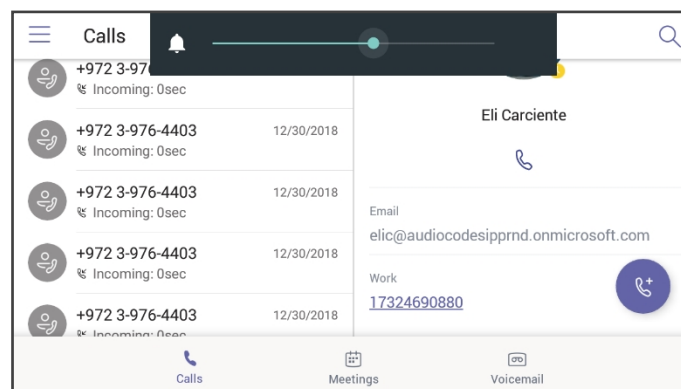
- Ring volume
- Tones volume (e.g., dial tone)
- Handset volume
- Speaker volume
- Headset volume

Adjusting Ring Volume

The volume of the phone's ring alerting you to an incoming call can be adjusted to suit personal preference.

➤ To adjust ring volume:

1. When the phone is in idle state, press the VOL  or VOL  key.





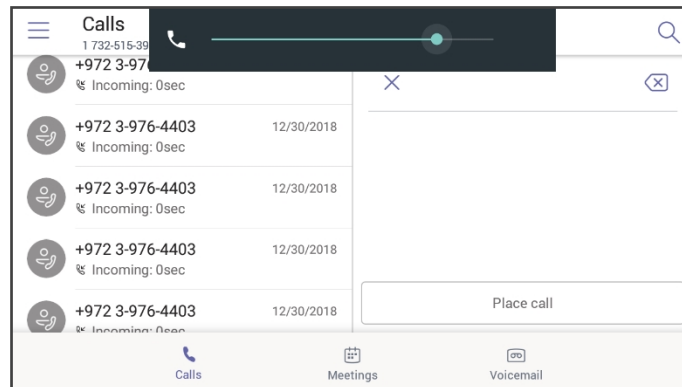
2. After adjusting, the volume bar disappears from the screen.

Adjusting Tones Volume

The phone's tones, including dial tone, ring-back tone and all other call progress tones, can be adjusted to suit personal preference.

➤ **To adjust tones volume:**

1. Off-hook the phone (using handset, speaker or headset).
2. Press the VOL  or VOL  key to adjust the volume.





3. After adjusting, the volume bar disappears from the screen.

Adjusting Handset Volume

Handset volume can be adjusted to suit personal preference. The adjustment is performed during a call or when making a call. The newly adjusted level applies to all subsequent handset use.



➤ **To adjust handset volume:**

1. During a call or when making a call, make sure the handset is off the cradle.
2. Press the VOL  or VOL  key; the volume bar shown in the preceding figure is displayed on the screen. After adjusting, the volume bar disappears from the screen.

Adjusting Speaker Volume

The volume of the speaker can be adjusted to suit personal preference. It can only be adjusted *during a call*.



➤ **To adjust the speaker volume:**

1. During a call, press the speaker key on the phone.
2. Press the VOL  or VOL  key; the volume bar is displayed on the screen. After adjusting the volume, the volume bar disappears from the screen.

Adjusting Headset Volume

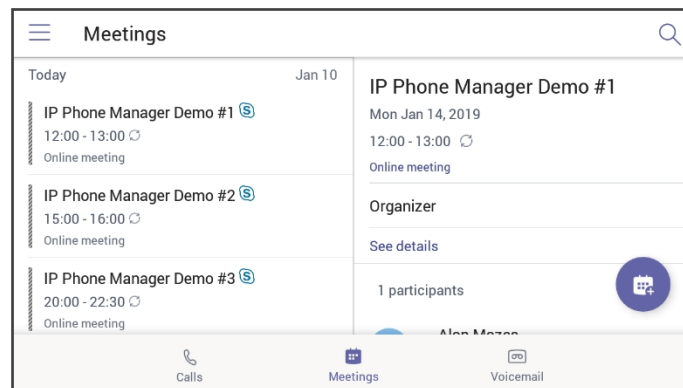
Headset volume can be adjusted *during a call* to suit personal preference.

➤ **To adjust the headset volume:**

1. During a call, press the headset hard key on the phone.
2. Press the VOL  or VOL  key; the volume bar is displayed on the screen.

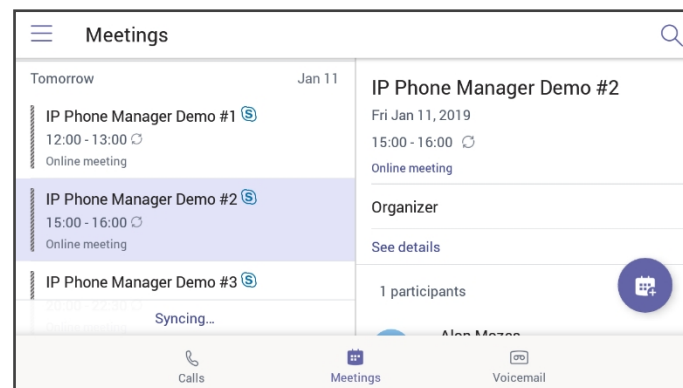
Managing Meetings

Meetings scheduled for today and for the next week can be viewed by touching the Meetings tab.



➤ To view the details of a meeting:

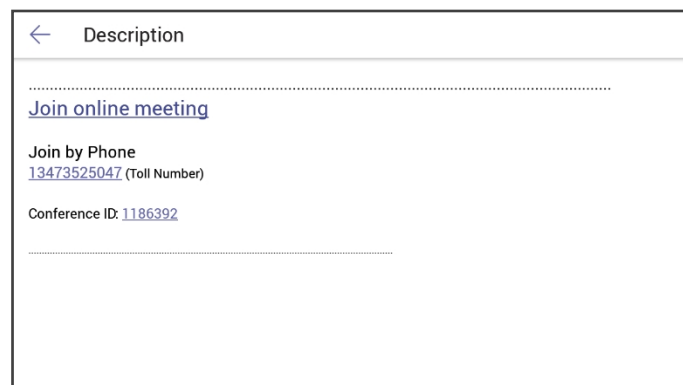
1. Scroll down to select the meeting whose details you want to view and touch it.



2. View in the right pane the details of the meeting.

➤ To join a meeting:

- In the meeting you want to join (see the preceding figure), touch the **See details** link.



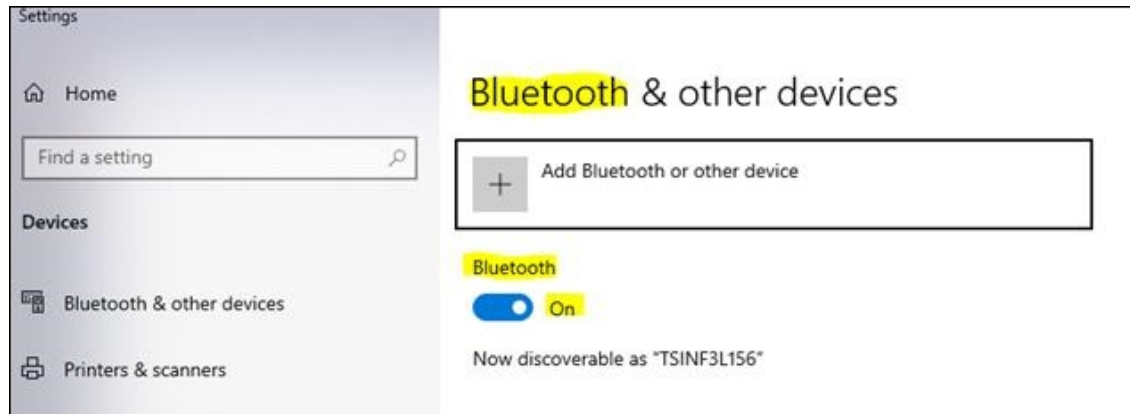
Better Together over Bluetooth

Read here about how to configure Better Together over Bluetooth with support for:

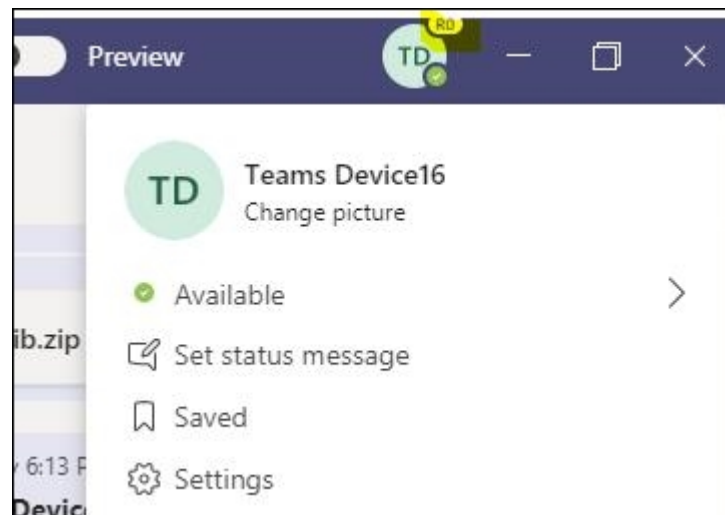
- Pairing with the Teams PC Client
- Lock/unlock synchronization

➤ To set up Bluetooth on the PC side:

1. Enable Bluetooth on your PC.

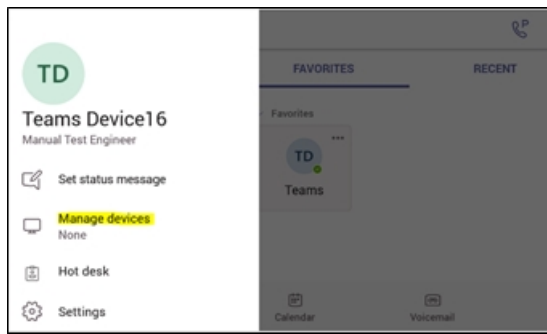


2. Install Teams PC Client on the PC.
3. Sign in to the Teams PC Client with your account (it's necessary to sign in with the same accounts to both the Teams PC Client and to the device).

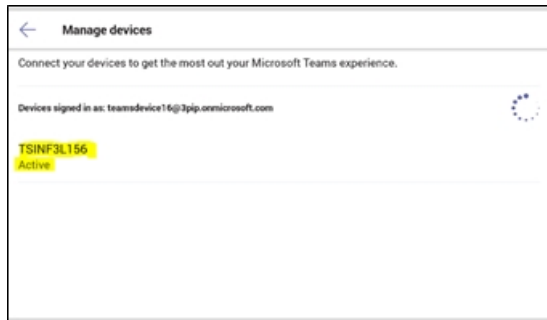


➤ To set up Bluetooth on the device side:

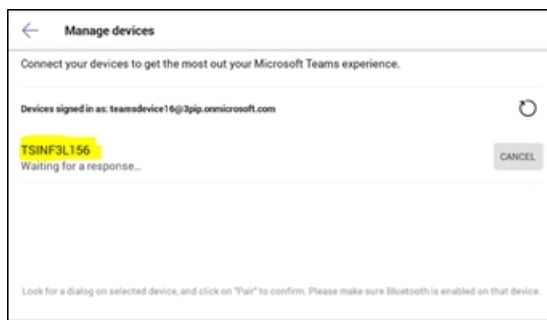
1. Sign in to the Teams application with your account (it's necessary to sign in with the same accounts to both the Teams PC Client and to the device).
2. Go to the hamburger menu on the device and click **Manage devices**.



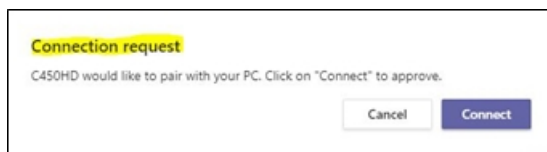
3. View the displayed available device to connect to.



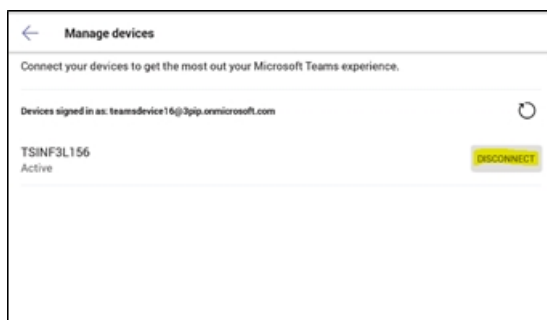
4. Pair the device with your PC.



5. View on your PC a notification it gets to accept the connection:



6. Accept the notification from PC.
7. Check the device and make sure pairing was successful:



6 Updating C450HD Phone Firmware Manually

The phone's firmware can be upgraded manually via Secure Shell (SSH) cryptographic network protocol.

➤ **To manually upgrade firmware to firmware that does not exist in Microsoft Admin Portal:**



- Make sure you have a command line tool that implements Secure Copy Protocol (SCP).
- Place the firmware file in the same directory from which this command line tool is running.

1. Open the Command prompt.
2. Run the following command:

```
scp C450HD_TEAMS_1.0.69.zip admin@10.16.2.50:/data/ota_
package/update_image.zip
```

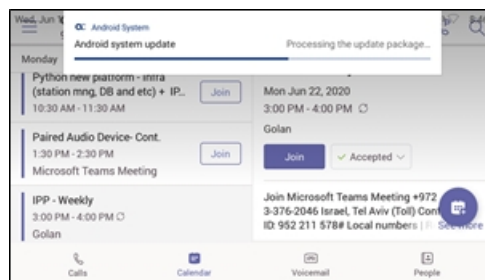


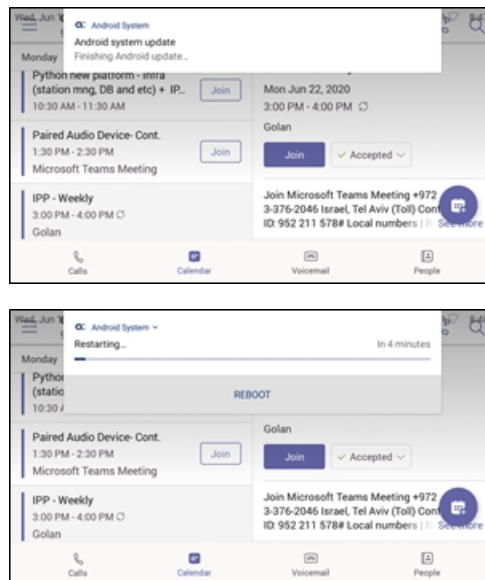
- In the preceding example, the phone's IP address is **10.16.2.50** and the firmware name is **C450HD_TEAMS_1.0.69.zip**
- The SCP command allows you to copy files over SSH connections.

3. Choose **Yes** and enter the phone admin password (default is **1234** or **1111** if you didn't perform restore default yet); the firmware is downloaded to the phone's memory.
4. Run the following command:

```
ssh admin@10.16.2.50 local_update.sh
```

5. Enter the Admin password; the firmware is burnt to the phone and the phone is automatically rebooted.
6. View the notification that is displayed to notify you that the phone is being updated and then rebooted.





The above notification is also displayed when the phone is upgraded remotely from Microsoft Admin Portal or from AudioCodes' Device Manager.

7 Troubleshooting

Users

Read the following documentation if an issue with your phone occurs. Contact your network administrator if necessary. Network administrators can also use the documentation following as reference.

Table 7-1: Troubleshooting

Symptom	Problem	Corrective Procedure
Phone is off (no screen displays and LEDs)	Phone is not receiving power	<ul style="list-style-type: none"> ■ Make sure the AC/DC power adapter is attached firmly to the DC input on the rear of the phone. ■ Make sure the AC/DC power adapter is plugged into the electrical outlet. ■ Make sure the electrical outlet is functional. ■ If using Power over Ethernet (PoE), contact your network administrator to check that the switch is powering the phone.
Phone is not ringing	Ring volume is set too low	<ul style="list-style-type: none"> ■ Increase the volume (see Adjusting Ring Volume on page 62)
Touch screen display is poor	Touch screen settings	<ul style="list-style-type: none"> ■ Adjust the phone's screen brightness
Headset has no audio	Headset not connected properly	<ul style="list-style-type: none"> ■ Make sure your headset is securely plugged into the headset port located on the side of the phone. ■ Make sure the headset volume level is adjusted adequately (see Adjusting Headset Volume on page 63).

Network Administrators

Network administrators can troubleshoot telephony issues in their networks using the following as reference.

Collecting Logs

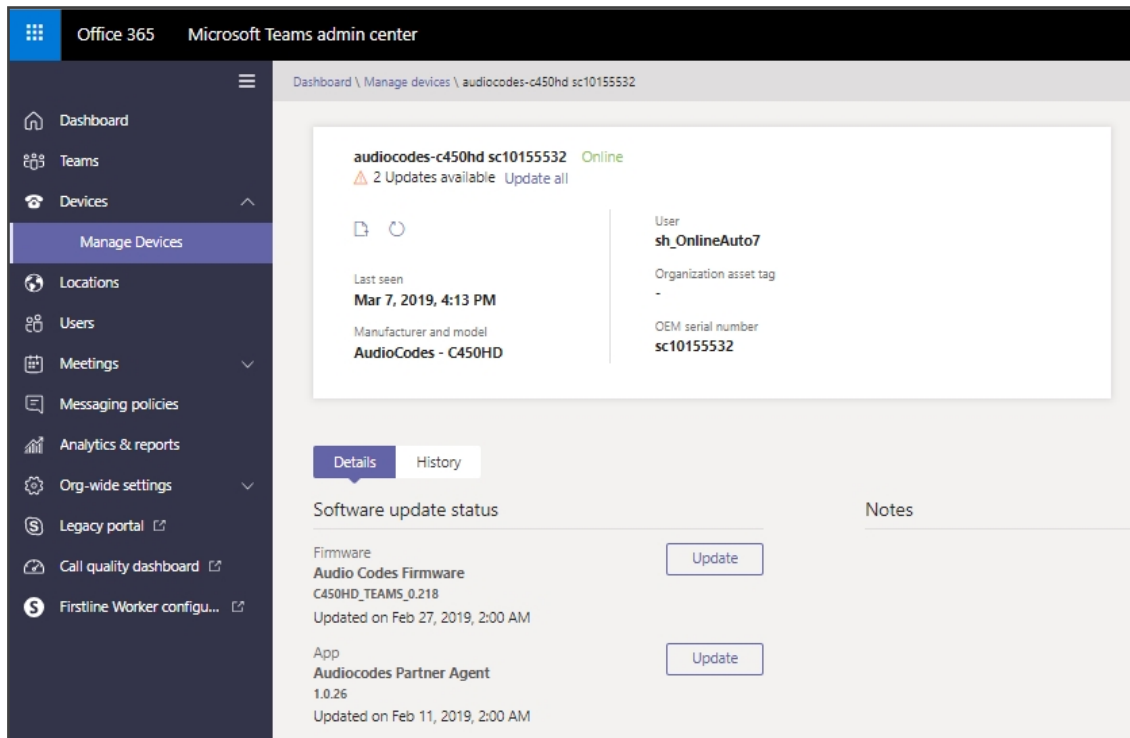
Device diagnostics (Logcat) can be collected using the Microsoft Admin Portal. For support purposes, general logs can be collected also using the Microsoft Admin Portal. The logs can

help debug Teams application issues and also for issues related to the device.

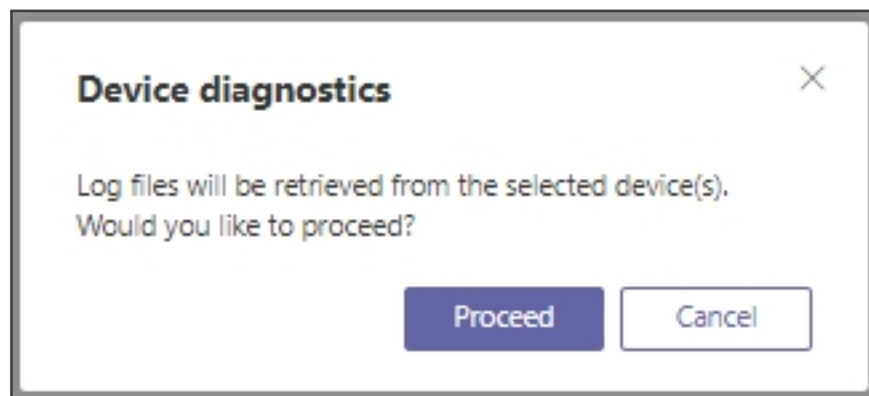
➤ **To collect logs:**

1. Reproduce the issue
2. Access Microsoft Admin Portal and under the **Devices** tab click the **Diagnostics** icon.

Figure 7-1: Microsoft Teams Admin Portal - Diagnostics

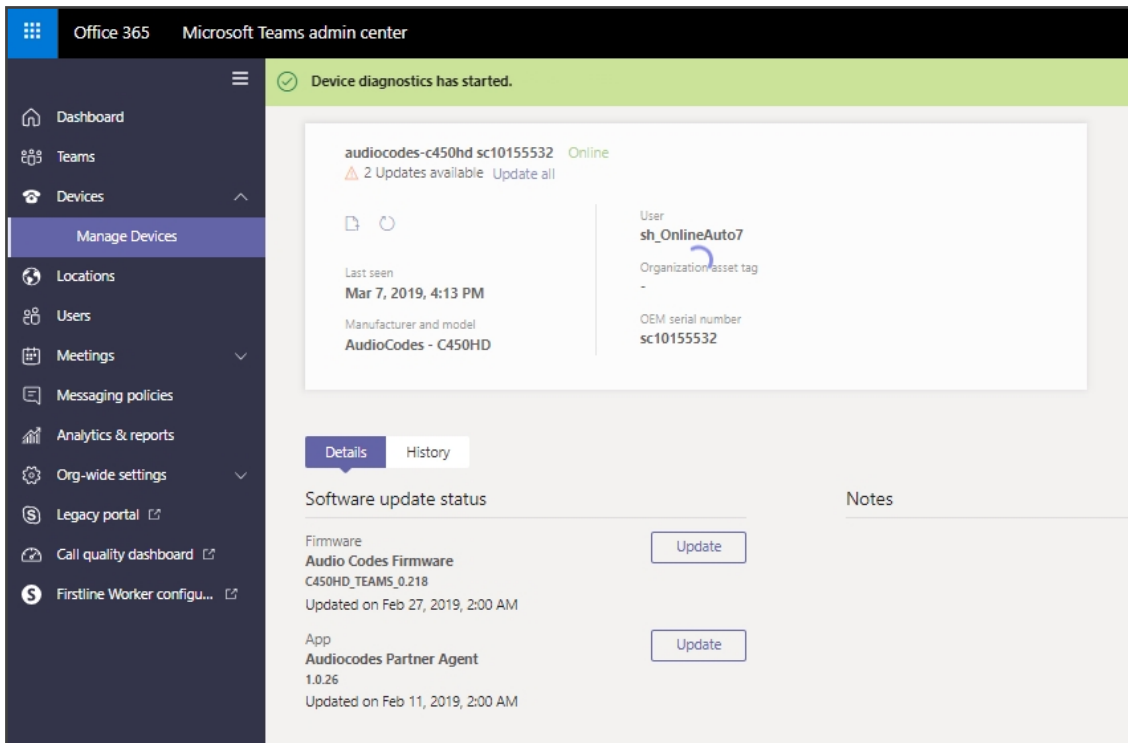


3. Click the **Diagnostics** icon .



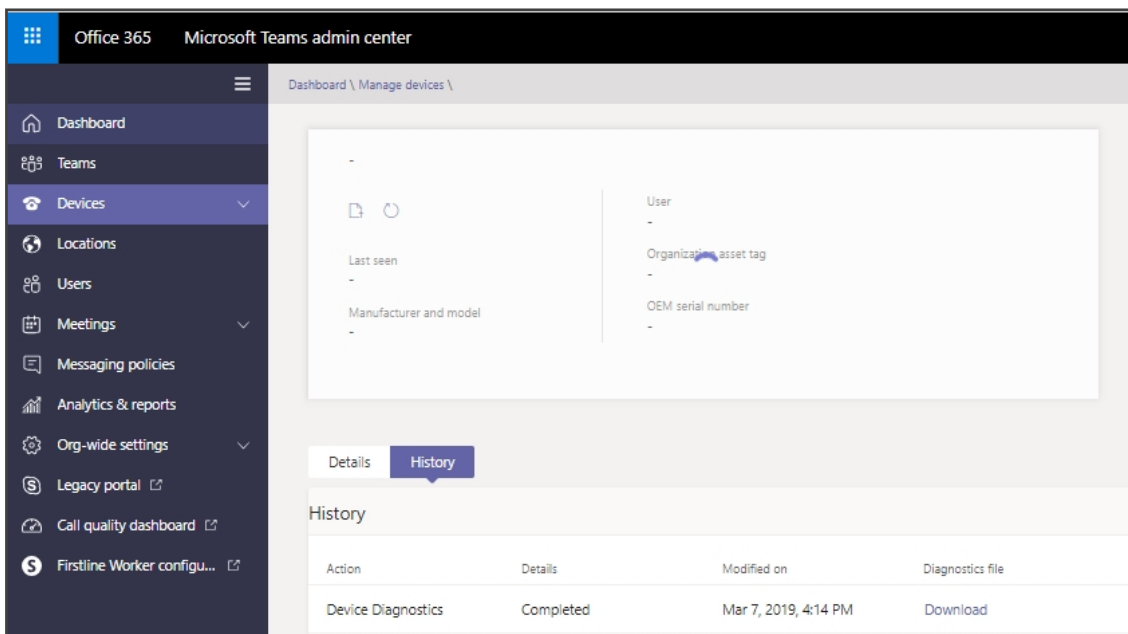
4. Click **Proceed**; the logs are uploaded to the server.

Figure 7-2: Microsoft Teams Admin Portal – Logs Upload to Server



5. Click the **History** tab.

Figure 7-3: History - Download



6. Click **Download** to download the logs.

Remote Logging

Remote Logging via Syslog provides the same log level as Device Diagnostics (performed via the Microsoft Admin Portal) with some additional information that may be relevant to device

issues (not Teams application issues).

Diagnostics via the Microsoft Admin Portal are saved to the device sdcard and collected after the event. Remote Logging via Syslog is different. The logs are collected in real time.

➤ **To enable from the phone Remote Logging via Syslog:**

1. Log in to the phone as Administrator and go back.
2. In the 'Device administration' screen, select **Debugging**.
3. Select **Remote logging**.



4. Configure the 'Remote IP address' and 'Remote port' and enable 'Remote Logging'; the device starts sending logs to the Syslog server.



Network administrators can also enable Syslog using Secure Shell (SSH) protocol.

➤ **To enable Syslog using SSH protocol, type the following command at the shell prompt:**

```
setprop persist.ac.rl_address <syslog_server_ip>:<port>.
```

➤ **To disable Syslog using SSH, type the following command at the shell prompt:**

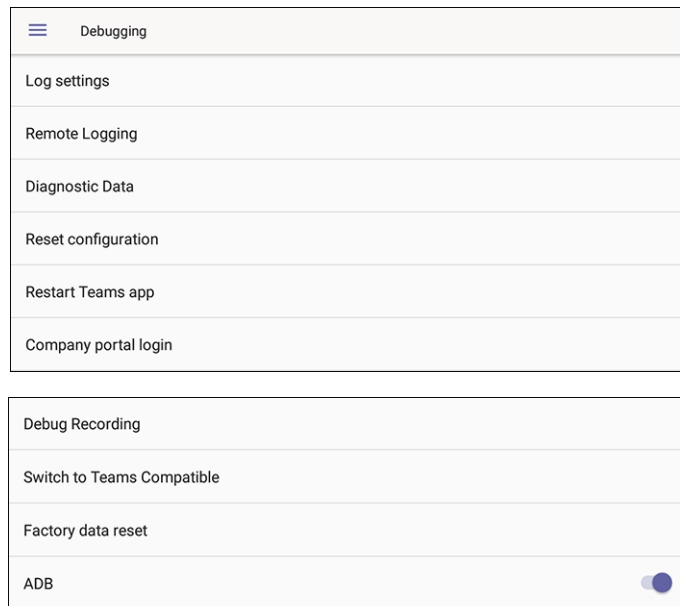
```
setprop persist.ac.rl_address ""
```

Diagnostic Data

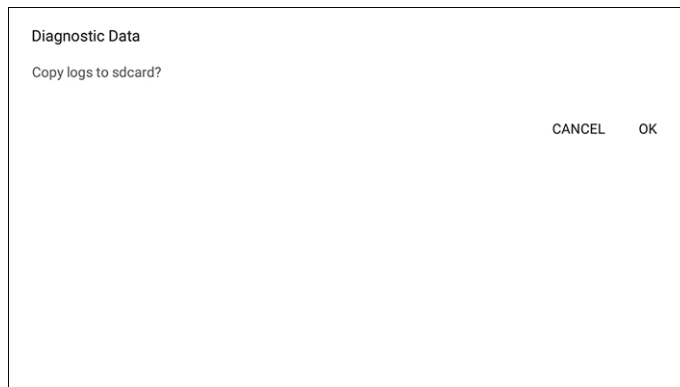
Admin users who need to get logs from the device can dump the logs to the phone's Secure Digital (SD) Card and then later collect them using Secure Copy Protocol (SCP) based on Secure Shell (SSH) protocol. Whenever an issue occurs, the Admin can dump the logs into the SD Card.

➤ **To use the tool:**

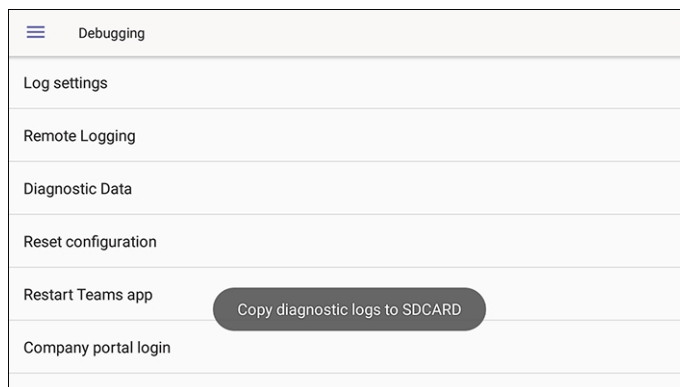
1. Log in to the phone as an Admin user
2. Open the Debugging screen (**Device Administration > Debugging**).



3. Touch the **Diagnostic Data** option.



4. Touch **OK** to confirm.



5. Wait until the screen shown in the preceding figure disappears; the phone creates all necessary logs and copies them to the its SD Card / Logs folder.
6. Get the logs using SCP notation as follows:

```
scp -r admin@host_IP:/sdcard/logs/
```

■ Following are the relevant logs (version and ID may be different to those shown here):

- ✓ dmesg.log
- ✓ dumpstate-TEAMS_1.3.16-undated.txt
- ✓ dumpstate_log-undated-2569.txt
- ✓ logcat.log

SSH

After Administrator sign-in for which you need to know the administrator username and password **admin** and **1234** are the defaults), the phone is accessed by default via Secure Shell (SSH) cryptographic network protocol.

SSH access allows network administrators more debugging capabilities. For example:

- Pulling files from the phone sdcard (using the curl command)
- Capturing the phone screen (see [Capturing the Phone Screen](#) below for more information)
- Running the tcpdump tool (see [Running the tcpdump Tool](#) on the next page for more information)

Using SSH, network administrators can also:

- Activate DSP recording (see [Activating DSP Recording](#) on the next page for more information)
- Get the phone's IP address (see [Getting the Phone IP Address](#) on page 76 for more information)
- Get version information (see [Getting Information about Phones](#) on page 76 for more information)
- Install the Teams apk (or any other apk) (see [Installing the Teams APK \(or Any Other APK\) using SSH](#) on page 77 for more information)

Capturing the Phone Screen

This feature allows network administrators to effectively collaborate to debug issues.

➤ To capture the phone screen:

1. Access the phone via SSH
2. Run a TFTP client on your PC
3. Set the phone to the screen to capture
4. Run the commands:

- ✓ screencap /sdcard/screen_cap.png
- ✓ curl -T /sdcard/screen_cap.png tftp://host_ip

Running the tcpdump Tool

Running under the command line, this common packet analyzer allows network administrators to display TCP/IP and other packets transmitted or received over the IP telephony network.

➤ To run tcpdump:

1. Access the phone via SSH and run the following commands:

```
cd /storage/emulated/0/  
mkdir recording  
cd recording/  
tcpdump -w rtp.pcap
```

2. After running TCPDump, reproduce the issue.
3. Press **Ctrl+C** to stop TCPDump:

```
curl -T /storage/emulated/0/recording/rtp.pcap tftp://host_ip/rtp.pcap
```

Activating DSP Recording

Network administrators can activate DSP recording using SSH protocol.

➤ To activate DSP recording using SSH protocol, type the following at the shell prompt:

```
setprop ac.dr_voice_enable true  
setprop ac.dr_ipaddr <ip_address>  
setprop ac.dr_port 50000
```



DSP recording can be activated on the fly without requiring the network administrator to reset the phone.

Deactivating DSP Recording

Network administrators can deactivate DSP recording using SSH protocol.

- To deactivate DSP recording using SSH protocol, type the following at the shell prompt:

```
setprop ac.dr_voice_enable false
```



DSP recording can be deactivated on the fly without requiring the network administrator to reset the phone.

Getting the Phone IP Address

Network administrators can get a phone's IP address using SSH protocol.

- To get the phone's IP address using SSH protocol, type the following at the shell prompt:

```
su
```

```
ifconfig
```

Getting Information about Phones

Network administrators can get information about phones using SSH protocol.

- To get *firmware information* from a phone using SSH protocol, type the following at the shell prompt:

```
getprop ro.build.id
```

- To get *Bootloader information* using SSH protocol, type the following at the shell prompt:

```
getprop ro.bootloader
```

- To get *DSP information* using SSH protocol, type the following at the shell prompt:

```
getprop ro.ac.dsp_version
```


- **To get the *Microsoft Teams version* using SSH protocol, type the following at the shell prompt:**

```
getprop ro.teams.version
```

- **To get the *Microsoft Company Portal version* using SSH protocol, type the following at the shell prompt:**

```
getprop ro.portal.version
```

- **To get the *Microsoft Admin version* using SSH protocol, type the following at the shell prompt:**

```
getprop ro.agent.version
```

Installing the Teams APK (or Any Other APK) using SSH

Network administrators can install the Microsoft Teams APK (or any other APK) using SSH protocol. Here's an example of how to replace the Microsoft Teams application version.

- **To replace the Microsoft Teams application version:**

1. Upload the .apk file to the phone

```
curl http://<ip_address>/Microsoft-Teams-xxx.apk > /data/teams.apk
```

2. Install the .apk

```
pm install -r -d /data/teams.apk
```

3. Remove the .apk from /data

```
rm /data/teams.apk
```

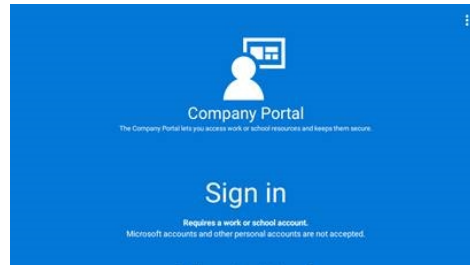
Getting Company Portal Logs

Company Portal logs can be helpful to network administrators when there are issues with signing in to Teams from the phone.

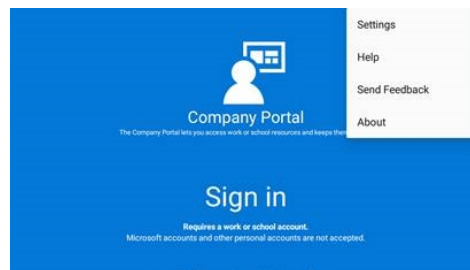
- **To get Company Portal logs:**

1. Reproduce the issue (logs are saved to the device so you first need to reproduce the issue and then get the logs).

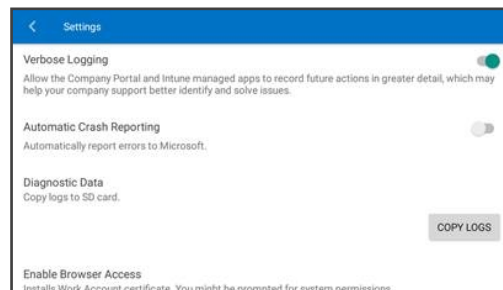
2. Log in to the phone as Administrator and then go back.
3. Touch the **Debugging** option under Admin.
4. Touch **Company Portal login**.
5. Touch the icon located in the uppermost right corner of the screen, shown in the next figure:



6. Touch **Settings**.



7. Touch the **Copy Logs** key.



Company portal logs are copied to:

```
sdcard/Android/data/com.microsoft.windowsintune.companyportal/files/
```

8. To pull the logs, use the ssh:

```
scp -r admin@hosp  
ip:/sdcard/android/data/com.microsoft.windowsintune.companyportal/files/ .
```

Files are quite heavy so you may need to pull them one by one.

Getting Audio Debug Recording Logs

Network administrators can opt to get Audio Debug Recording logs from the phone screen. The purpose of these logs is for issues related to media.

➤ To enable Audio Debug Recording logs:

1. Log in as Administrator.
2. Press the MENU hard key and then scroll down in the Settings screen to **Debug**.



3. Touch **Debug** and then scroll down to **Debug Recording**.



4. Configure the remote IP address and port.
5. Enable 'Voice record'.
6. Start Wireshark on your PC to capture the Audio traffic.

Collecting Media Logs (*.blog) from the Phone

Network administrators can collect Media Logs (*.blog) from the phone.

➤ To collect Media Logs (*.blog) from the phone

1. Access the phone via SSH.
2. Set the phone to the screen to capture.
3. Run the following command:

```
scp -r admin@hosp_  
ip:/sdcard/android/data/com.microsoft.skype.teams.ipphone/cache/ .
```

This page is intentionally left blank.

International Headquarters

1 Hayarden Street,

Airport City

Lod 7019900, Israel

Tel: +972-3-976-4000

Fax: +972-3-976-4040

AudioCodes Inc.

200 Cottontail Lane

Suite A101E

Somerset NJ 08873

Tel: +1-732-469-0880

Fax: +1-732-469-2298

Contact us: <https://www.audiocodes.com/corporate/offices-worldwide>

Website: <https://www.audiocodes.com/>

©2020 AudioCodes Ltd. All rights reserved. AudioCodes, AC, HD VoIP, HD VoIP Sounds Better, IPmedia, Mediant, MediaPack, What's Inside Matters, OSN, SmartTAP, User Management Pack, VMAS, VoIPerfect, VoIPerfectHD, Your Gateway To VoIP, 3GX, VocaNom, AudioCodes One Voice, AudioCodes Meeting Insights, AudioCodes Room Experience and CloudBond are trademarks or registered trademarks of AudioCodes Limited. All other products or trademarks are property of their respective owners. Product specifications are subject to change without notice.

Document #: LTRT-13274

