

# SmartTAP 360° Live

## SmartTAP 360° Live Enterprise Recording Solution

Version 5.3

Smart**TAP** 360° Live



## Notice

Information contained in this document is believed to be accurate and reliable at the time of printing. However, due to ongoing product improvements and revisions, AudioCodes cannot guarantee accuracy of printed material after the Date Published nor can it accept responsibility for errors or omissions. Updates to this document can be downloaded from <https://www.audiocodes.com/library/technical-documents>.

This document is subject to change without notice.

Date Published: March-04-2021

## WEEE EU Directive

Pursuant to the WEEE EU Directive, electronic and electrical waste must not be disposed of with unsorted waste. Please contact your local recycling authority for disposal of this product.

## Customer Support

Customer technical support and services are provided by AudioCodes or by an authorized AudioCodes Service Partner. For more information on how to buy technical support for AudioCodes products and for contact information, please visit our website at <https://www.audiocodes.com/services-support/maintenance-and-support>.

## Documentation Feedback

AudioCodes continually strives to produce high quality documentation. If you have any comments (suggestions or errors) regarding this document, please fill out the Documentation Feedback form on our website at <https://online.audiocodes.com/documentation-feedback>.

## Stay in the Loop with AudioCodes



## Abbreviations and Terminology

Microsoft Skype for Business and Microsoft Lync are used interchangeably in this document unless otherwise specified. References to Microsoft Teams are explicitly indicated.

## Related Documentation

Document Name
SmartTAP 360° Live Release Notes
SmartTAP 360° Live Administrator Guide
SmartTAP 360° Live for Microsoft Teams Deployment Guide

## Document Revision Record

LTRT	Description
27191	<p>Added Sections: Enabling Opus Recording on the SmartTAP 360° Live Media Server; Configuring Opus in SIPREC; Example for Creating a Self-signed Certificate; Installing the Application Service; Installing SmartTAP 360° Live Application Server; Example for Creating a Self-Signed Certificate for CD-SIPREC and SBC Connection (Create a Certificate Signing Request (CSR); Sign the Certificate at the Certificate Authority (CA); Import Certificate to CD_SIPREC Certificate Store); Generating Certificates Automatically; Generated Certificates Manually</p> <p>Updated Sections: Verify the Target List in Each Call Delivery; Media Delivery (MD); Configuring Gateway &amp; SBC for SIP Recording; Windows Event Log; Editing Media Proxy Server Parameters; Step 3-Configuring Announcement Server (Skype for Business); Active / Standby Resiliency Configuration (Optional); Microsoft Hyper-V; Supported Microsoft Windows Platforms; Media Server and Remote Transfer Service with HTTPS; Installation Prerequisites</p>
27192	<p>Updated figure in Section Skype for Business Recording; Updated table SmartTAP Server - INBOUND Firewall; Updated table Edge, Mediation or Conference Server(s) - Outbound Firewall</p>
27193	<p>Added Section: Microsoft Teams Deployment Specifications</p> <p>Updated Sections: Active / Standby Resiliency Configuration (Optional); Installing the Remote Transfer Service; Skype for Business Recording Firewall; Edge, Mediation or Conference Server(s); SmartTAP 360° Live Server (Firewall); SmartTAP 360° Live Media Proxy Server; Manual Disabling of HTTP</p>
27194	<p>Updated Sections: Update to Microsoft Teams Deployment Specifications</p>
27195	<p>Updated Sections: Server Configurations; Microsoft Teams Deployment Specifications; Installing the Remote Transfer Service; Media Server; Distributed SmartTAP 360° Live Firewall; Backup</p>

LTRT	Description
27196	Added Section: Media Server with HTTPS; Installing CD-Live Component; CD-Live with HTTPS; Supported Microsoft Integrations Removed Section "Enabling OPUS Codec Recordings in SmartTAP" Updated Section: Distributed SmartTAP Firewall; Hardware and Software Requirements; Call Delivery with HTTPS; Health Monitor with HTTPS; Media Delivery with HTTPS; Media Server with HTTPS; Installation Wizard - Distributed Method Removed Section: Known Issues (Internet Explorer)
27197	Update to the Microsoft Teams Bot Cluster Specifications; correction for "Standard Load Balancer"

---

## Table of Contents

---

<b>1</b>	<b>Hardware and Software Requirements</b>	<b>1</b>
	SmartTAP 360° Live for Microsoft Teams Requirements	1
	SmartTAP 360° Live Server Specifications	2
	Microsoft Teams Bot Cluster Specifications	2
	Microsoft Teams Instant Message Service CD-Live Component - Beta version for POC	4
	SmartTAP 360° Live for Microsoft Teams Availability	4
	SmartTAP 360° Live for Microsoft Teams Backup and Restore	4
	SmartTAP SIPRec Deployment in Azure - Minimum Specifications	4
	Requirements for Other Integrations	5
	Server Configurations	5
	Network Adapter Configuration	9
	General Configuration	9
	VMWare Specific	9
	Telephony Integration Hardware	10
	Add-On Blades	10
	Power Requirements	10
	Antivirus Software	10
	Windows Defender	10
	Supported Microsoft Integrations	11
	Supported Microsoft Windows OSS	11
	Supported Virtual Machine (VM) Environments	11
	VMware ESXi	11
	Microsoft Hyper-V	11
	Active / Standby Resiliency Configuration (Optional)	11
	HTML5 Media Player Browser Support	12
	Windows Updates	12
	Installing Windows Updates	12
<b>2</b>	<b>SmartTAP 360° Live License Management</b>	<b>14</b>
	License File Creation and Installation	14
	License File Creation	14
	License File Installation and Verification	15
	SmartTAP 360° Live Upgrades	15
<b>3</b>	<b>Before Installing SmartTAP 360° Live</b>	<b>17</b>
	SmartTAP 360° Live Software Package Contents	17
	Installation Prerequisites	17
	Installation Wizard Methods	19
	All-In-One	19
	Distributed	19
	Post Installation Actions	19
<b>4</b>	<b>Installation Wizard - All-In-One Method</b>	<b>21</b>
	Database Service	23

Installing the Application Service .....	24
Installing the Communication Service .....	28
Installing the Call Delivery Service .....	29
Installing the Media Server .....	31
Installing the Remote Transfer Service .....	32
Installing CD-Live Component .....	34
Completing Wizard Installation .....	38
Post-Installation Integration .....	39
<b>5 Installation Wizard - Distributed Method .....</b>	<b>40</b>
Installing SmartTAP Database Server .....	42
Database Service Configuration .....	42
Installing SmartTAP 360° Live Application Server .....	43
Installing SmartTAP Communication Server .....	43
Installing SmartTAP Media Server .....	44
Media Server Configuration .....	45
Network File Server .....	45
Media Server .....	49
Installing SmartTAP Call Delivery Server .....	51
SmartTAP 360° Live File Server Installation .....	51
Firewall Configuration .....	52
Domain Controller Configuration .....	52
<b>6 Uninstalling SmartTAP 360° Live .....</b>	<b>57</b>
<b>7 Firewall Configuration .....</b>	<b>59</b>
Skype for Business Recording Firewall .....	59
Front End Server(s) .....	59
Edge, Mediation or Conference Server(s) .....	60
SmartTAP 360° Live Server .....	61
SmartTAP 360° Live Media Proxy Server .....	62
SmartTAP 360° Live Announcement Server .....	62
Automated Firewall Exception Scripts for Windows Firewall .....	63
Distributed SmartTAP Firewall .....	63
Application Server (AS) .....	65
Communications Server (CS) .....	65
Database Server (DB) .....	66
File Server (FS) .....	66
Media Server (MS) .....	66
Remote Transfer Service (RTS) .....	66
Call Delivery(CD) .....	67
Media Delivery (MD) .....	68
Media Proxy (MP) .....	68
Announcement Server (AN) .....	68
Example .....	69
OVOC Server .....	69

<b>8</b>	<b>Microsoft Skype for Business Deployment</b>	<b>70</b>
	Skype for Business Remote Branch Site	71
	Before Installing Microsoft Skype for Business Components	73
	Announcement Server-Specific Requirements	74
	Firewall Configuration	74
	SmartTAP 360° Live Monitoring Service-Specific Requirements	74
	Installing Skype for Business Plugin	75
	Skype for Business Plugin-Pre-install Setup on AD Domain Controller	75
	Skype for Business Plugin Pre-install Setup on each Front End, SBS or SBA	79
	Skype for Business Plugin Installation Procedure	88
	Installing Call Delivery for Skype for Business (IP-based Recording)	95
	Monitoring	97
	Edge	102
	Firewall Exceptions	104
	Configuring Media Proxy for Call Delivery-IP	104
	Configuring Call Delivery for Skype for Business	107
	Installing Media Proxy Server for Skype for Business	108
	Modifying Media Proxy Server Parameters	115
	Installing Media Delivery Server for Skype for Business	116
	Installing Announcement Server	117
	Announcement Server Preinstall of Core Components and Local Replica Configuration Store	118
	Announcement Server Software Installation Procedure	122
	Announcement Server-Post Installation Procedures	127
	Step 1-Activate Announcement Services	127
	Step 2-Add Announcement Servers to DNS	128
	Step 3-Configuring Announcement Server (Skype for Business)	128
	Installing SmartTAP Monitoring Service	129
	SmartTAP 360° Live Monitoring Service Installation Procedure	130
	Activating the SmartTAP 360° Live Monitoring Service	131
	Configuring the SmartTAP Monitoring Service	132
<b>9</b>	<b>Integration Configuration</b>	<b>135</b>
	VoIP Port Mirroring	135
	Inbound / Outbound	135
	Station to Station	135
	Call Delivery Install for VoIP (Port Mirror)	136
	Additional Configuration for VoIP Port Mirroring	139
	Setting Up Monitoring Interfaces	141
	Analog Trunk / Radio	142
	Call Delivery Install for Analog Recording (Passive Tap)	144
	Additional Configuration for Analog Trunk and Radio	146
	Activity Detection	149
	SmartCONTROL	150
	SIP Recording (SIPRec)	151
	What is SIPRec?	151

Session Recording Server (SRS) .....	152
Session Recording Client (SRC) .....	152
Configuring Gateway & SBC for SIP Recording .....	152
Configuring Load Balancing on the SBC Device .....	153
Configuring Alternative Routing on the SBC .....	154
Installing SmartTAP 360° Live for SIP Recording .....	155
Configuring Call Delivery for SIP Recording .....	156
Recording Genesys PureCloud Contact Center Calls Locally .....	157
Configuring Message Manipulation Rules Genesys PureCloud Contact Center Calls .....	158
Adding SmartTAP to the Genesys PureCloud Contact Center User Interface .....	160
<b>10 Additional Configuration Options .....</b>	<b>163</b>
Configuring Digital Signatures .....	163
Installing the Digital Signatures Property Sheet .....	163
Configuring LDAP .....	164
Pre-Requisites .....	164
Configuring SSO .....	165
Configuring HTTP/S .....	165
Disabling HTTP Communications on Application Server (Optional) .....	165
Automatic Disabling of HTTP .....	165
Manual Disabling of HTTP .....	166
Configuring SmartTAP 360° Live Components for HTTPS .....	167
Communication Server for HTTPS .....	167
Call Delivery with HTTPS .....	167
Media-Proxy with HTTPS .....	168
Announcement Server with HTTPS .....	169
Remote Transfer Service with HTTPS .....	169
Health Monitor with HTTPS .....	170
Media Delivery with HTTPS .....	170
Media Server with HTTPS .....	171
CD-Live with HTTPS .....	171
Configuring Syslog Server Connection .....	172
Skype for Business Plug-in .....	172
Location-Based Targeting in SmartTAP .....	173
Assign a Location Attribute to each Call Delivery Component .....	173
Create a Location Attribute in the SmartTAP GUI .....	175
Assign a Location to Each User/Device in the SmartTAP GUI .....	176
Verify the Target List in Each Call Delivery .....	178
CD-SIPREC Configuration .....	179
CD-SIPREC Support in TLS Transport .....	180
Generating Certificates Automatically .....	180
Generating Certificates Manually .....	182
Example for Creating a Self-Signed Certificate for CD-SIPREC and SBC Connection .....	183
Create a Certificate Signing Request (CSR) .....	183
Sign the Certificate at the Certificate Authority (CA) .....	184



Import Certificate to CD-SIPREC Certificate Store .....	184
<b>11 Backup and Restore .....</b>	<b>186</b>
Prerequisites .....	186
Backup .....	187
Call Delivery Service .....	187
Media Service .....	188
Media Delivery Service: Installed on Skype for Business Edge, Mediation or Conference Server .....	188
Communication Service .....	188
Application Service .....	189
Database .....	189
SmartTAP 360° Live Skype for Business Plug-in (FE, SBS, SBA) .....	190
SmartTAP 360° Live Announcement Server .....	190
SmartTAP 360° Live Media Proxy .....	190
Media .....	190
System Profile Tool .....	191
Restore .....	191
Call Delivery Service .....	192
Media Service .....	192
Media Delivery Service .....	193
Database .....	193
SmartTAP 360° Live Skype for Business Plug-in (FE, SBS, SBA) .....	193
Announcement Server .....	194
Media Proxy .....	194
Restoring Media .....	194
<b>12 Troubleshooting .....</b>	<b>196</b>
How To Validate Port Mirror for Recording Skype for Business Calls .....	196
Prerequisites .....	196
Introduction: SmartTAP Recording Concepts .....	196
SmartTAP 360° Live Processing of Skype for Business Signaling .....	196
SmartTAP 360° Live Media Processing .....	197
Procedure .....	198
Setup Skype for Business Logging .....	198
Setup Sniffer .....	199
Capture a Test Call .....	199
Analysis .....	200
Locate Test Call in Skype for Business Log .....	200
Compare Call Information with Sniffer Trace .....	202
Determine Whether SmartTAP will Record this Call .....	202
Troubleshooting Skype for Business Plugin Installation .....	202
Enable the Browser Service .....	202
Use “net view” to Verify .....	203
Troubleshoot Skype for Business Recording .....	203
No Records for the Calls .....	203

---

Calls with No Audio .....	204
Enabling Promiscuous Mode on VMWare ESXi .....	204
<b>13 Configure Microsoft SNMP Service .....</b>	<b>205</b>
Automatic SNMP Setup .....	205
Manual SNMP Setup .....	206

# 1 Hardware and Software Requirements

This chapter describes the hardware and software requirements for installing SmartTAP 360° Live Enterprise Recording Solution including the following:

- [SmartTAP 360° Live for Microsoft Teams Requirements](#) below
- [SmartTAP SIPRec Deployment in Azure - Minimum Specifications](#) on page 4
- [Requirements for Other Integrations](#) on page 5
- [Windows Updates](#) on page 12

## SmartTAP 360° Live for Microsoft Teams Requirements

This section describes the recommended specifications for SmartTAP 360° Live Recording solution for Microsoft Teams through the Microsoft policy-based API. SmartTAP 360° Live for Microsoft Teams can record Voice, Video, Screen Sharing and Instant Messaging for internal, PSTN and Federated calls.



For details on SmartTAP 360° Live for Microsoft Teams Recording Policy:

<https://docs.microsoft.com/en-us/microsoftteams/teams-recording-policy>



- For integrations with third-party applications, a custom specification is required.
- Video and Screen Sharing calls playback and download are limited to two concurrent sessions.

This section includes the following:

- SmartTAP 360° Live Server Specifications
- [Microsoft Teams Bot Cluster Specifications](#) on the next page
- [Microsoft Teams Instant Message Service CD-Live Component - Beta version for POC](#) on page 4
- [SmartTAP 360° Live for Microsoft Teams Availability](#) on page 4
- [SmartTAP 360° Live for Microsoft Teams Backup and Restore](#) on page 4



SmartTAP SIPRec integration is supported when using the Teams SBC for recording PSTN calls. For details, see [SmartTAP SIPRec Deployment in Azure - Minimum Specifications](#) on page 4

## SmartTAP 360° Live Server Specifications

- Operating System: Microsoft Windows Server 2016 or Microsoft Windows Server 2019
- SmartTAP server with the specifications below can handle up to 3000 targeted users and 500 concurrent audio call recordings:
  - Virtual Machine: Tier=Standard, Instance=DS2 v2 (2 vCPUs, 7 GB RAM, 14 GB Temporary storage)
  - Virtual Machine: Tier=Standard, Instance=DS3 v2 (4 vCPUs, 14 GB RAM, 28 GB Temporary storage) - recommended
- SmartTAP server with the specifications below can handle up to 3000 targeted users and a combination of 500 concurrent audio, video and screen sharing call recordings.
  - Virtual Machine: Tier=Standard, Instance=F8s v2 (8 vCPUs, 16 GB RAM, 64 GB Temporary storage)
- SmartTAP server with the specifications below can handle up to 100 targeted users and 20 maximum concurrent audio call recordings. Post recording features for the below machine specifications are limited to basic playback and download. In case of a maximum recording levels of 20 concurrent audio calls, the playback and download of recordings may be delayed or take a longer time to complete. Use the machine for average loads that are not higher than 10 audio concurrent recordings and for Proof-of-Concepts (POCs).
  - Virtual Machine: B2MS 2 vCPUs, 8 GB RAM
- An additional managed disk is required for database storage. The size of the disk should be large enough to hold the media, the estimated size of the media can be calculated using the SmartTAP storage calculator. In case of temporarily media, make sure the disk has enough capacity to hold recordings' media over a time that external storage may not be accessible (see [Server Configurations](#) on page 5). The additional managed disk is not required for POC if the SmartTAP Server's OS disk has sufficient space to hold the database. The disk should be a premium SSD managed disk.
  - For SmartTAP Server specifications when deployed On-premises other than Azure cloud, please consult with the SmartTAP support team.

## Microsoft Teams Bot Cluster Specifications

Microsoft Teams Bot can be deployed using one of the below options:

- **Azure Service Fabric Cluster:** Azure Service Fabric Cluster with Silver Durability with a minimum of 5 nodes and maximum of 10 nodes (for testing or POCs, Bronze Durability with 1 or 3 nodes can be used) is required:
  - Virtual Machine: Tier=Standard, Instance=DS2 V2 or D2 V2 (2 vCPUs, 7 GB RAM)
  - Windows Server 2019 Data Center - with Containers

For more information, refer to [Microsoft Service Fabric Cluster](#).

**Table 1-1: Service Fabric Cluster Concurrent Calls Recordings Table**

Media in a Call	Maximum total Calls per vCPU
Voice	25
Voice and video (p2p or group calls up to 4 streams)	4
Voice and screen sharing	15

■ **Azure Standalone Cluster:** Standalone cluster including one of the VM specifications below:

- Virtual Machine: Tier=Standard, Instance=DS2 V2 (2 vCPUs, 7 GB RAM)
- Virtual Machine: Tier=Standard, Instance=DS3 v2 (4 vCPUs, 14 GB RAM)
- Virtual Machine: Tier=Standard, Instance=DS4 v2 (8 vCPUs, 28 GB RAM)

**Table 1-2: Standalone Cluster Concurrent Calls Recordings Table**

Media in a Call	Maximum total Calls per vCPU
Voice	40
Voice and video (p2p or group calls up to 4 streams)	8
Voice and screen sharing	25

■ **Additional mandatory Azure resources:**

- Deployed in Service Fabric Cluster:
  - ◆ Standard Load Balancer for Bot Service Fabric Cluster
  - ◆ Virtual Machine ScaleSet – VMs for Bot Service Fabric Cluster
- Public IP address for the Standard Load Balancer (for Standard Load Balancer in case of SFC)
- Key Vault to store Bot Service Fabric Cluster certificates
- Microsoft Azure Blob Storage

■ **Optional Azure resources:**

- Application Insights to store Bot logs
- App Configuration to store Bot configuration

## Microsoft Teams Instant Message Service CD-Live Component - Beta version for POC

- Installed as a component of the SmartTAP server on Azure (Ds2 V2 2 vCPUs, 7 GB RAM or higher)
- Installed as a Standalone VM on Azure (B2MS 2 vCPUs, 8 GB RAM)



CD-Live cannot be installed On-premises.

## SmartTAP 360° Live for Microsoft Teams Availability

SmartTAP 360° Live for Microsoft Teams availability is based on Azure Virtual Machines (VM) Service Level Agreement (SLA):

- SmartTAP Server on Azure VM - SLA is 99.9% for one instance and 99.99% can be achieved by deploying the two servers in different Availability Zones (optionally available at extra cost). Refer to [Azure VM SLA](#).
- SmartTAP 360° Teams BOT on Azure VM - SLA 99.9% (99.95% Service Fabric Cluster). Refer to [Azure VM SLA](#).
- SmartTAP Media on Azure BLOB – SLA is 99.9% for Hot tier, and 99% for Cool Tier. Refer to [Azure Blob Storage SLA](#).
- The durability of Azure Blob using Local Redundant Storage (LRS) is 11 nines. Refer to [Azure Blob Storage Durability](#).

## SmartTAP 360° Live for Microsoft Teams Backup and Restore

Azure Virtual Machines (VM) backup/restore procedures are highly recommended.

## SmartTAP SIPRec Deployment in Azure - Minimum Specifications

SmartTAP SIPRec recording deployment can be used to record Teams PSTN calls that the SBC or gateway handles.



For deployments other than Azure, see [Requirements for Other Integrations](#) on the next page.

SmartTAP SIPRec server:

- B2MS: 2 vCPUs, 8 GB RAM: Low-profile for up to 100 users and 20 concurrent audio calls
- DS2\_v2, 2 vCPUs, 7-GB RAM: Low-profile SmartTAP for up to 50 concurrent audio recordings

- F4s\_v2, 4 vCPUs, 8-GB RAM: Middle-profile SmartTAP for up to 150 concurrent audio recordings
- F8s\_v2, 8 vCPUs, 16 GB RAM: High-profile SmartTAP 360° for up to 250 concurrent audio recordings.
- An additional managed disk is required for database storage. The estimated size of the required disk can be calculated using the SmartTAP storage calculator (see [Server Configurations](#) below). The additional managed disk is not required for POC if the SmartTAP Server's OS disk has sufficient space to hold the database. The disk should be a premium SSD managed disk.
- **SmartTAP SIPRec availability:** SmartTAP SIPRec availability is based on Azure Virtual Machines (VM) Service Level Agreement (SLA):
  - SmartTAP Server on Azure VM - SLA is 99.9% for one instance and 99.99% can be achieved by deploying the two servers in different Availability Zones (optionally available at extra cost). Refer to [Azure VM SLA](#)
- **SmartTAP SIPRec Backup/Restore:** Azure Virtual Machines (VM) backup/restore procedures are highly recommended.

## Requirements for Other Integrations

This section describes requirements for other integrations including Skype for Business and Microsoft Lync including:

- [Server Configurations](#) below
- [Network Adapter Configuration](#) on page 9
- [Telephony Integration Hardware](#) on page 10
- [Antivirus Software](#) on page 10
- [Windows Defender](#) on page 10
- [Supported Microsoft Integrations](#) on page 11
- [Supported Microsoft Windows OSS](#) on page 11
- [Supported Virtual Machine \(VM\) Environments](#) on page 11
- [Active / Standby Resiliency Configuration \(Optional\)](#) on page 11
- [HTML5 Media Player Browser Support](#) on page 12

## Server Configurations

The following table lists the maximum available resources for three different SmartTAP 360° Live server profiles and for the Media Proxy and Announcement servers.



- Resources refers to Audio, Video, Announcement and Video and Screen Sharing licenses.
- When SmartTAP 360° Live server is deployed on Microsoft Azure, see [SmartTAP 360° Live for Microsoft Teams Requirements](#) on page 1

**Figure 1-1: SmartTAP 360° Live Server**

Server	Specification	Available Resources
SmartTAP 360° Live server (Low Profile)	<ul style="list-style-type: none"> <li>2 Core 2.5 GHz</li> <li>6 GB Memory</li> <li>2 SATA 7200 RPM HDD/SSD*</li> <li>PCIe slots FL / FH2**</li> </ul>	50 resources (audio only)
		25 resources when Media Proxy Service is installed on the same server (audio only)
SmartTAP 360° Live server (Medium Profile)	<ul style="list-style-type: none"> <li>6 Cores 2 GHz****</li> <li>8 GB Memory</li> <li>2 SATA 7200 RPM HDD/SSD*</li> <li>PCIe slots FL / FH2**</li> </ul>	150 resources
		50 resources when Media Proxy Service is installed on the same server (audio only)
SmartTAP 360° Live server*** (High Profile)	<ul style="list-style-type: none"> <li>12 Core 2 GHz****</li> <li>14 GB Memory</li> <li>2 SATA 7200 RPM HDD/SSD*</li> <li>PCIe slots FL / FH2**</li> </ul>	300 resources 500 audio resources
Media Proxy server***	<ul style="list-style-type: none"> <li>Quad Core 2 GHz (300 resources)</li> <li>8 Core 2 GHz (500 audio resources)</li> <li>8 GB Memory</li> <li>SATA 7200 RPM HDD/SSD*</li> </ul>	300 resources 500 audio resources
Announcement server***	<ul style="list-style-type: none"> <li>Quad Core 2 GHz</li> <li>8 GB Memory</li> <li>SATA 7200 RPM HDD/SSD*</li> </ul>	300 resources (assuming the announcement length does not exceed 20% of an average call length)

\* SmartTAP 360° Live server requires two dedicated HDDs/SSDs - one for the Windows OS, SmartTAP 360° Live software and DB. The size of the disk should be large enough to hold the media, the estimated size of the media can be calculated using the SmartTAP storage calculator. In case of the temporarily media, make sure the disk has enough capacity to hold



recordings' media over a time that external storage may not be accessible. Another disk is required for the recorded media. The media HDD is required for both local or remote media storage (in the case of remote storage it is used for intermediate storage of the media). When running the SmartTAP 360° Live Server in a virtual environment, the HDDs/SSDs has to be dedicated and mapped to SmartTAP 360° Live server VM.

**\*\*** PCIe Full Length / Full Height slots. The number of slots required is determined by the number of Analog Stations required to record. Each card can record 24 channels (i.e., 56 Phones will require three PCIe card slots).

**\*\*\*** A group of these servers can be deployed when more than the supported recording capacity in one server is required. An additional high-end server is required to be deployed for the Application Server and Database.

**\*\*\*\*** Higher CPU speed (higher than 2.0 GHz) is recommended to accelerate download and playback for Video and Video and Screen Sharing recorded calls.



- When running in a virtual environment, all specification resources in the table above must be reserved for all servers of SmartTAP 360° Live.
- Dual GB NIC interfaces are required for VoIP Port Mirroring Integration Configuration (this is not relevant for Skype for Business and SIP Recording)

To determine the server specification, calculate the required available resources. The calculation of the required resources is based on the number of licenses multiplied by one of the factors specified in the table below.

**Figure 1-2: License Factors**

License Type	Factor
Audio Recorder License	1
Video Recorder License	10
Announcement License	1
Video and Screen Sharing	5

- Calculate the required number of resources on the SmartTAP 360° Live server and the Media Proxy server according to the following formula:

**Required Number of Resources = (Number of Audio Recorder Licenses)\*(Audio Recorder License Factor) + (Number of Video Recorder Licenses)\*(Video Recorder License Factor) + (Number of Video and Screen Sharing Recorder Licenses)\*(Video and Screen Sharing Factor)**

Choose the SmartTAP 360° Live server and Media Proxy server with the number of available resources equal or higher than the required recording resources.

- Calculate the required number of resources on the Announcement server according to the following formula:

Required Number of Resources = (Number of Announcement Licenses)\*(Announcement License Factor)

**Example 1:** 100 Audio Recorder Licenses

- Required Number of Resources = (100 Audio Recorder Licenses)\*(1 Audio Recorder License Factor) = 100
- Choose Medium Profile SmartTAP 360° Live server and one Media Proxy server

**Example 2:** 30 Video Recorder Licenses

- Required Number of Resources = (30 Video Recorder Licenses)\*(10 Video Recorder License Factor) = 300
- Choose High Profile SmartTAP 360° Live server and one Media Proxy server

**Example 3:** 50 Audio Recorder Licenses and 20 Video Recorder Licenses

- Required Number of Resources = (50 Audio Recorder Licenses)\*(1 Audio Recorder License Factor) + (20 Video Recorder Licenses)\*(10 Video Recorder License Factor) = 50 + 200 = 250
- Choose High Profile SmartTAP 360° Live server and one Media Proxy server

**Example 4:** 40 Audio Recorder Licenses

- Required Number of Resources = (40 Audio Recorder Licenses)\*(1 Audio Recorder License Factor) = 40
- Choose either of the following:
  - Medium Profile SmartTAP 360° Live server with Media Proxy service installed on the SmartTAP 360° Live server
  - Low Profile SmartTAP 360° Live server and separate Media Proxy server

**Example 5:** 200 Audio Recorder Licenses with Announcement

- For SmartTAP 360° Live server and Media Proxy servers:
  - Required Number of Resources = (200 Audio Recorder Licenses)\*(1 Audio Recorder License Factor) = 200
  - Choose High Profile SmartTAP 360° Live server and one Media Proxy server
- For Announcement server:
  - Required Number of Resources = (200 Announcement Licenses)\*(1 Announcement License Factor) = 200
  - Choose one Announcement server

**Example 6:** 50 Audio Recorder Licenses and 50 Video and Screen Sharing Recorder Licenses

- For SmartTAP 360° Live server and Media Proxy servers:
  - Required Number of Resources = (50 Audio Recorder Licenses)\*(1 Audio Recorder License Factor) + (50 Video and Screen Sharing Recorder Licenses)\*(5 Video and Screen Sharing Recorder License Factor) = 300

- Choose High Profile SmartTAP 360° Live server and one Media Proxy server

## Network Adapter Configuration

To provide optimal media quality for audio/video (A/V) calls and to cope with unexpected spikes in traffic and increased usage over time, additional network requirements for SmartTAP 360° Live and MediaProxy servers must be implemented.

### General Configuration

- Increase Network Adapter Resources:
  - Receive and Send buffers - increase the allocated resources. For receive-intensive scenarios, it is recommended to increase the receive buffer value to at least 8 MB.
- Enable Receive Side Scaling (RSS)
- Offload Features - disable Offload operations to ease the load on network adapter
- Suggested Reference:
  - <https://technet.microsoft.com/en-us/library/jj574151>

### VMWare Specific

- Install VMWare tools
- Set network interface adapter type to vmxnet3
- Edit network adapter advanced options:
  - Enable "Receive Side Scaling"
  - Set "Large Rx Buffer" to at least 8 MB
  - Set "Small Rx Buffers" to at least 8MB
  - Set "Rx Ring #1/#2 Size" to at least 4MB
  - Disable all Offload settings
- Suggested References:
  - <https://kb.vmware.com/s/article/2008925>
  - <https://kb.vmware.com/s/article/2039495>

## Telephony Integration Hardware

### Add-On Blades

**Table 1-3: Add-On Blades**

Interface	Description	Connector	Gender
Analog	<ul style="list-style-type: none"> <li>■ 24 channel PCIe Full Length Full Height Card</li> <li>■ 6' 180 degree Male to 90 degree female cable included</li> </ul>	RJ21x	Female

- Connect male end of 6' cable to card and female end to in-house wiring.
- All cards are x1 PCI 3.0 compliant. The cards will also function in x4, x8, x16 and Gen 2.0 PCI Express slots.

### Power Requirements

**Table 1-4: Power Requirements**

Interface	+3.3Vdc	+5Vdc	-12Vdc	+12Vdc	Watts
Analog	2.3A	n/a	n/a	n/a	7.6W

- Ensure the Power Supply is adequate to support ALL the devices installed in the server not just the Add-On Blades.

### Antivirus Software

- No virus software is included with SmartTAP
- No specific virus software is tested or certified
- If installed, do not scan the following folders and contents to prevent performance impact.
  - Media path: (i.e., Local D:\Media, SAN or NAS)
  - ...\Ai-Logix\
  - ...\AudioCodes\
  - ...\MySQL\

### Windows Defender

- It is similar to Virus software. Please disable scanning same file types and folders.

## Supported Microsoft Integrations

- Microsoft Lync Server 2013
- Skype for Business 2015
- Skype for Business 2019
- Microsoft Teams

## Supported Microsoft Windows OSS

- Microsoft Windows Server 2019
- Microsoft Windows Server 2016
- Microsoft Windows Server 2012 R2

## Supported Virtual Machine (VM) Environments

### VMware ESXi

- Version 4.1 and higher (IP-based integrations only)
- See [Enabling Promiscuous Mode on VMWare ESXi](#) on page 204 for instructions on how to enable promiscuous mode required for a SmartTAP 360° Live system that is monitoring (tapping) the network.

### Microsoft Hyper-V

- Microsoft Windows Server 2019
- Microsoft Windows Server 2016
- Microsoft Windows Server 2012 R2
- Microsoft Windows Server 2012 64bit



Hyper-V does not support promiscuous mode. Do not use in Passive integration environments.

## Active / Standby Resiliency Configuration (Optional)

AudioCodes supports Microsoft Windows Clustering in the failover configuration, which provides high available service to the SmartTAP application. To support this type of install, the following is required:

- Two identical Windows servers which meet the minimum specifications mentioned above.
- A SAN (Storage Area Network) with iSCSI support. The SmartTAP cluster requires at least 2 Internet Small Computer System Interface (iSCSI) targets - one for the disk witness/quorum, and another for the DB and shared application data. A 3<sup>rd</sup> iSCSI target

“Optional” is required for the media storage. SmartTAP should not be configured to write the media directly to the 3<sup>rd</sup> media target; instead, it should be set as Media Transfer Service destination.

## HTML5 Media Player Browser Support

The following table describes the SmartTAP HTML5 player functionality support for web browsers.

The following table describes the supported browser features for each Player function.

**Table 1-5: HTML5 Media Player Browser Support**

SmartTAP HTML5 Player function	Browser Features
Playback	Canvas 2D graphics, AudioElement with MP3 or WebM/Opus support
Wave form rendering	Canvas 2D graphics, AudioElement/ Media Source Extensions with MP3 or WebM/Opus support, Web Audio API
Stereo wave form rendering	Canvas 2D graphics, AudioElement/Media Source Extensions with MP3 support, Web Audio API
Streaming	Canvas 2D graphics, AudioElement/Media Source Extensions with MP3 or WebM with VP8 and Opus support, Web Audio API, Readable streams



The web browser has to support the media framework (browser feature) that SmartTAP utilizes for streaming media as well as for rendering the audio wave forms as described in the table above.

## Windows Updates

- It is recommended to disable Automatic Windows Updates to prevent unknown side effects.
- AudioCodes only certifies major version Service Pack updates.



Before applying Windows updates, ensure that a system backup is performed.

## Installing Windows Updates

- Schedule a maintenance window. SmartTAP does not record during this timeframe.
- Download and install Windows updates.

- Reboot the server, even if Windows does not ask you to reboot to finish installing updates.
- Windows may continue installing updates after the system restart which may cause instability within SmartTAP.
- Once the Windows updates are complete, reboot the server again.

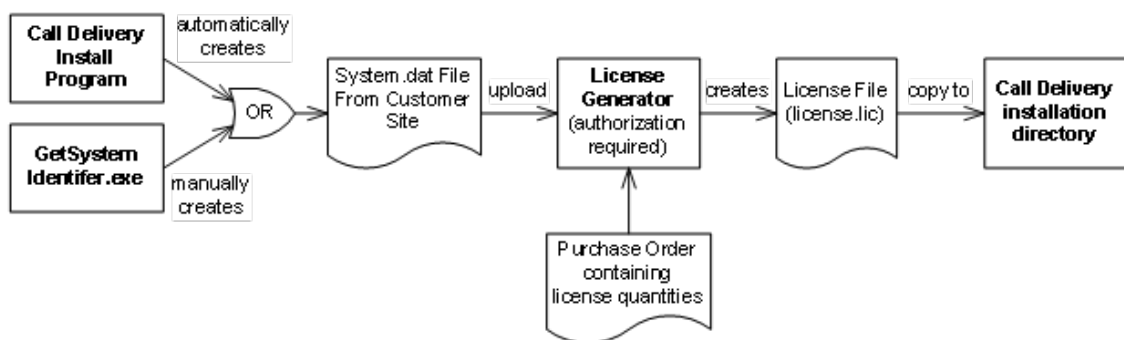
## 2 SmartTAP 360° Live License Management

This chapter describes how to calculate the required SmartTAP 360° Live licenses according to system specifications.

### License File Creation and Installation

This section describes how to collect the files that are required for SmartTAP license creation and how to install the license files on the target system. This process applies to SmartTAP 4.0.0 and above.

Figure 2-1: License Generator



### License File Creation

Two SmartTAP components require licensing: Call Delivery-IP and Call Delivery-SIPREC. Call Delivery-AES, which is no longer supported, also requires licensing. When Call Delivery is installed, it installs a program “GetSystemIdentifier.exe” in the installation directory. This program is automatically run and generates a file called “System-[MachineName].dat”, which can be found in the installation directory. This file must be retrieved and sent to AudioCodes to create a license file that is keyed to the customer’s hardware.

The default installation directory is found here: **C:\Program Files (x86)\AudioCodes\SmartTAP\CD-xx**

where xx represents which type of Call Delivery is installed.



If the customer’s installation environment changes significantly, it may affect the validation of the license file. If it becomes necessary to generate a new license file, the “GetSystemIdentifier.exe” program can generate a new “System.dat” file simply by double-clicking on the program. No other action is required.

Once the “System.dat” file is delivered to AudioCodes, an authorized employee will create a license file using the purchased license counts from the Purchase Order.

A license file must be generated for each copy of each type of Call Delivery that supports licensing. For example, if the customer requires both CD-IP and CD-SIPREC for their SmartTAP



recorder, two license files must be generated. If the customer has 3 sites, each with a copy of Call Delivery-IP installed, then each of the three will require a separate license file.

## License File Installation and Verification

Once a license file is generated, it is installed in the Call Delivery installation directory . This is the same location as the “System.dat” file. The default installation directory location is:

```
C:\Program Files (x86)\AudioCodes\SmartTAP\CD-xx
```

where xx represents the type of Call Delivery installed.



If there are multiple license files, it is important that each one is installed in the location of its corresponding “System.dat” file. There is a one-to-one relationship between “System.dat” and “license.lic”.

The license file must be named “license.lic”. If it has been renamed to help clarify to which system it belongs, the name must be changed back to “license.lic” before Call Delivery can load it.

Call Delivery must be restarted after the license file has been copied into the installation directory. From this moment, the license will take effect (if it has been generated correctly).

To verify the contents of the license file, refer to “Managing Licenses” in the *SmartTAP 360° Live Administrator Guide*. The “Licenses” page under the “System” tab in the SmartTAP User Interface display the license quantities and meta-data for each license file that is active in the system. If the Customer Name is reported as “Demo”, then this indicates that the license has not taken effect.

## SmartTAP 360° Live Upgrades

In general, SmartTAP 360° Live components are designed to be backward compatible regarding license files. Therefore, when performing an upgrade from one SmartTAP 360° Live version to another, it is generally not necessary to make any licensing changes with the following exceptions:

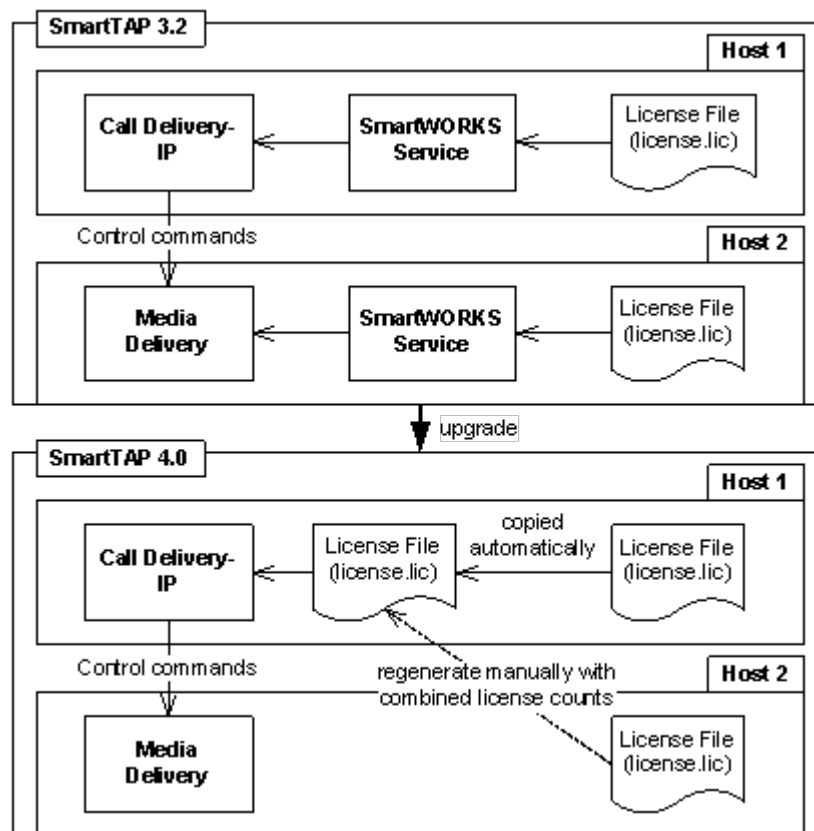
- If you are moving any licensed component (like Call Delivery) to another server or virtual machine, you will need to collect a new system.dat file and regenerate the license file. This might occur if you are changing the type of recording solution or the type of PBX being recorded.
- When adding one or more additional RDDs (Remote Data Delivery) as part of the upgrade, treat the additional RDD(s) as new installations and generate license files as described for new installations.

Prior to SmartTAP 360° Live 4.0, Call Delivery was licensed through SmartWORKS Service. For such systems, the license file was stored in the SmartWORKS installation directory. During the upgrade, the license file is automatically copied into the Call Delivery installation directory with

no changes, and Call Delivery will function as it did prior to the upgrade. There is no intervention required in this case. License files located in the SmartWORKS installation directory for SmartTAP 360° Live 4.0 and higher are ignored.

A special case occurs if the upgrade involves a SmartTAP 360° Live solution that includes Media Delivery from a version prior to version 4.0. Before SmartTAP 360° Live 4.0, Media Delivery relied on SmartWORKS Service, which required a license file. Beginning with SmartTAP 360° Live 4.0, Media Delivery no longer uses SmartWORKS Service and does not require a license file. Media Delivery will ignore a license file if one is present. Its behavior is controlled by the licenses residing with Call Delivery-IP. A new license file must be generated for CD-IP with sufficient licenses for all of the Media Delivery components to which it communicates. The exact license counts will depend on the customer's existing solution.

Figure 2-2: SmartTAP 360° Live Upgrades



For upgrades of CD-SIPREC prior to SmartTAP 360° Live 4.0, a new license file must be generated according to the license quantities originally purchased by the customer. This is done in the same manner as for the CD-IP, which is described above.

### 3 Before Installing SmartTAP 360° Live

This chapter describes important information that you should note prior to installing SmartTAP 360° Live.

#### SmartTAP 360° Live Software Package Contents

The installation package must be copied to a directory on the server where the SmartTAP 360° Live software is to be installed.

**Figure 3-1: Package Contents (Root Folder)**

Contents	Description
Microsoft Lync and Skype for Business	Includes Microsoft Lync 2013, and Skype-for-Business plugin installers for Front End Server or SBA
REST API Documentation	Contains web based reference material for REST API
RESTApiWrapperLibrary	Contains C# library and web based reference. Use instead of native REST
Suite	Describes the main SmartTAP 360° Live installation package folder
Tools	Contains various utilities for installing and troubleshooting SmartTAP 360° Live
SmartTAP 360° Live Release Notes.pdf	Describes the new features, issues resolved and any known issues for the SmartTAP 360° Live software release.
SmartTAP 360° Live InstallationGuide.pdf	Defines the Installation setup for the SmartTAP 360° Live software.

#### Installation Prerequisites

Before running the installation wizard, the following prerequisites must be met:



For each machine with a Database or Communication Server installed, there must have at least 12 GB on the drive where "mysql" is installed. View the installation path for "mysql" by opening the Services window and viewing the executable path.

- Base Windows 64 bit operating system installation complete without any additional software or features enabled
- Specific SmartTAP 360° Live hardware must be plugged into the server
- “Optional” PCI cards for Analog Station recording

- Specific SmartTAP 360° Live network tapping hardware/software must be setup:
  - Depending upon the integration method, Port SPAN/Port Mirror configured and cable with spanned/mirrored traffic connected to the NIC(s) ports that will be recording
  - “Optional” PCI card with cabling connected to the tapping hardware on the customer premises
- Host Server Microsoft SNMP Agent must be installed on the Storage server if different from the SmartTAP server for storage statistics and on the servers in branches (RDD) for system health presentation (for more information, see [Configure Microsoft SNMP Service](#) on page 205 below).
- Ensure that the Windows PowerShell script execution policy is set as follows on all of the servers where SmartTAP 360° Live components are installed:
  - Group Policy “Unrestricted”
  - If Group Policy is not defined, the execution policy of the logged CurrentUser or LocalMachine should be either Unrestricted or RemoteSigned .
  - To check the execution policy, run the following command:

```
PS> Get-ExecutionPolicy -list
```

- To change the execution policy, you can run the following commands:

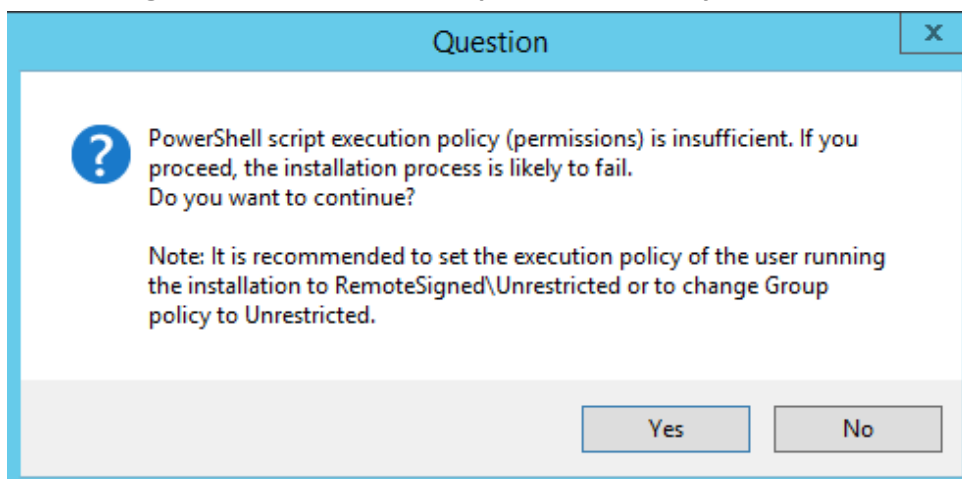
```
PS> Set-ExecutionPolicy -scope CurrentUser Unrestricted
```

```
PS> Set-ExecutionPolicy Unrestricted
```

```
PS> Set-ExecutionPolicy -scope LocalMachine Unrestricted
```

If the permissions are insufficient, the following message is displayed during the installation:

**Figure 3-2: PowerShell Script Execution Policy**



- Do one of the following:
  - a. If you are sure that you have set the correct execution policy, click Yes to continue.
  - b. If you would like to test your policy settings, click No and restart the installation.

## Installation Wizard Methods

The installation package is divided into multiple elements and typically installed on one server; however, can be installed on multiple servers depending upon customer requirements. An Installation Wizard is provided to install SmartTAP 360° Live with one of these configuration as follows:

- All-In-One installation for a Single server installation platform
- Distributed installation for a Multi-server installation platform

### All-In-One

This method installs the following default SmartTAP components in a single Wizard process, including recording and integration components. For more information, proceed to [Chapter Installation Wizard - All-In-One Method](#) on page 21 (recording components and [Chapter Integration Configuration](#) on page 135 (integration components).

### Distributed

The Distributed method allows you to perform Stand-alone installations of the separate installation components. You may wish to use a Distributed installation for any of the following reasons:

- If you need to add/remove a specific component
- If you need to setup survivable recording at SBA location (SmartTAP RDD)
- If you need to install SmartTAP Media Proxy or Announcement Server for Skype for Business.
- If some SmartTAP elements will reside on different servers.
- If you are installing Analog Station Integration.
- If you are installing SIPRec.



This installation method assumes that each SmartTAP component will be installed on a separate physical or virtual server.

- Proceed to Chapter [Installation Wizard - Distributed Method](#) on page 40.

## Post Installation Actions

After you have successfully installed SmartTAP 360° Live using one of the methods described above, there are additional actions required to fully setup the SmartTAP 360° Live network.

- Configure Firewall rules: The deployment of the SmartTAP 360° Live servers may have to comply with customer security policies, which require the implementation of firewall rules. You need to configure these rules in the Enterprise. See Chapter [Firewall Configuration](#) on page 59.
- Integrate SmartTAP 360° Live with other network components:
  - Skype for Business (see [Microsoft Skype for Business Deployment](#) on page 70)
  - SIPRec (see Section) [SIP Recording \(SIPRec\)](#) on page 151
  - Analog trunk/radio (see [Analog Trunk / Radio](#) on page 142)
- VoIP Port Mirroring to receive the unencrypted Signaling and RTP from different IP PBX station side-tapping configurations using a mirror port or network tap appliance (see [VoIP Port Mirroring](#) on page 135)
- Additional Configuration options:
  - Configuration Digital Signatures (see [Configuring Digital Signatures](#) on page 163 )
  - Configuring LDAP (see [Configuring LDAP](#) on page 164 )
  - Configuring SSO (see [Configuring SSO](#) on page 165)
  - Configuring HTTP/S (see [Configuring HTTP/S](#) on page 165)
- At the end of a clean installation, upgrade or maintenance update, the installer process goes to the "PostInstallation" folder, scans the files with the extensions exe,bat and ps1and runs each one of them in alphabetical order. AS host.properties automatically includes multicast IP addresses in \_PostInstallation folder.

## 4 Installation Wizard - All-In-One Method

The installation package is divided into multiple elements and typically installed on one server; however, can be installed on multiple servers depending upon customer requirements. This chapter describes the most common SmartTAP 360° Live installation on a single server.

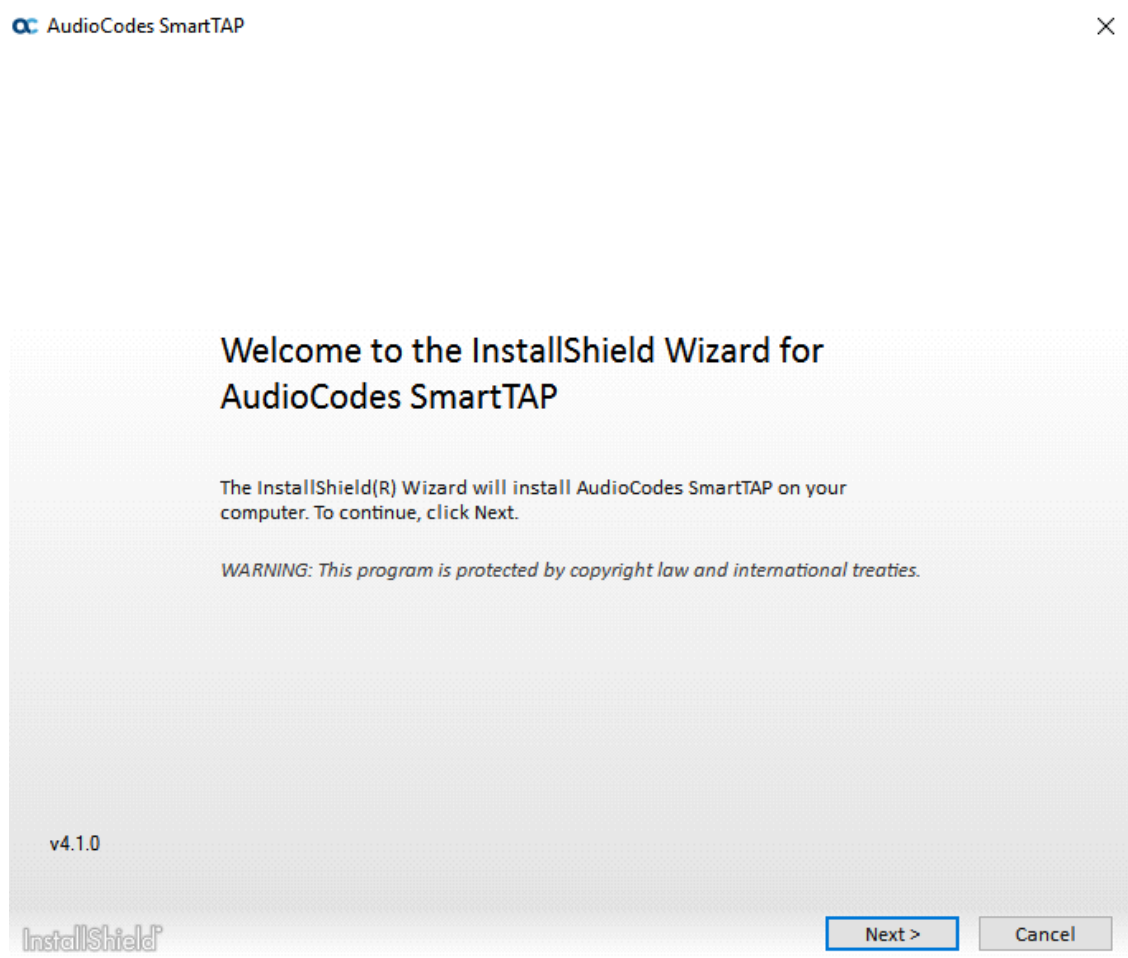


- See [Installation Wizard - Distributed Method](#) on page 40 for installations that involve more than one SmartTAP 360° Live server.
- If you are running a clean installation or upgrade, you may be prompted to restart the server. In this case, the installer prompts for a server restart; perform this action and then upon completion, run the installation script again.

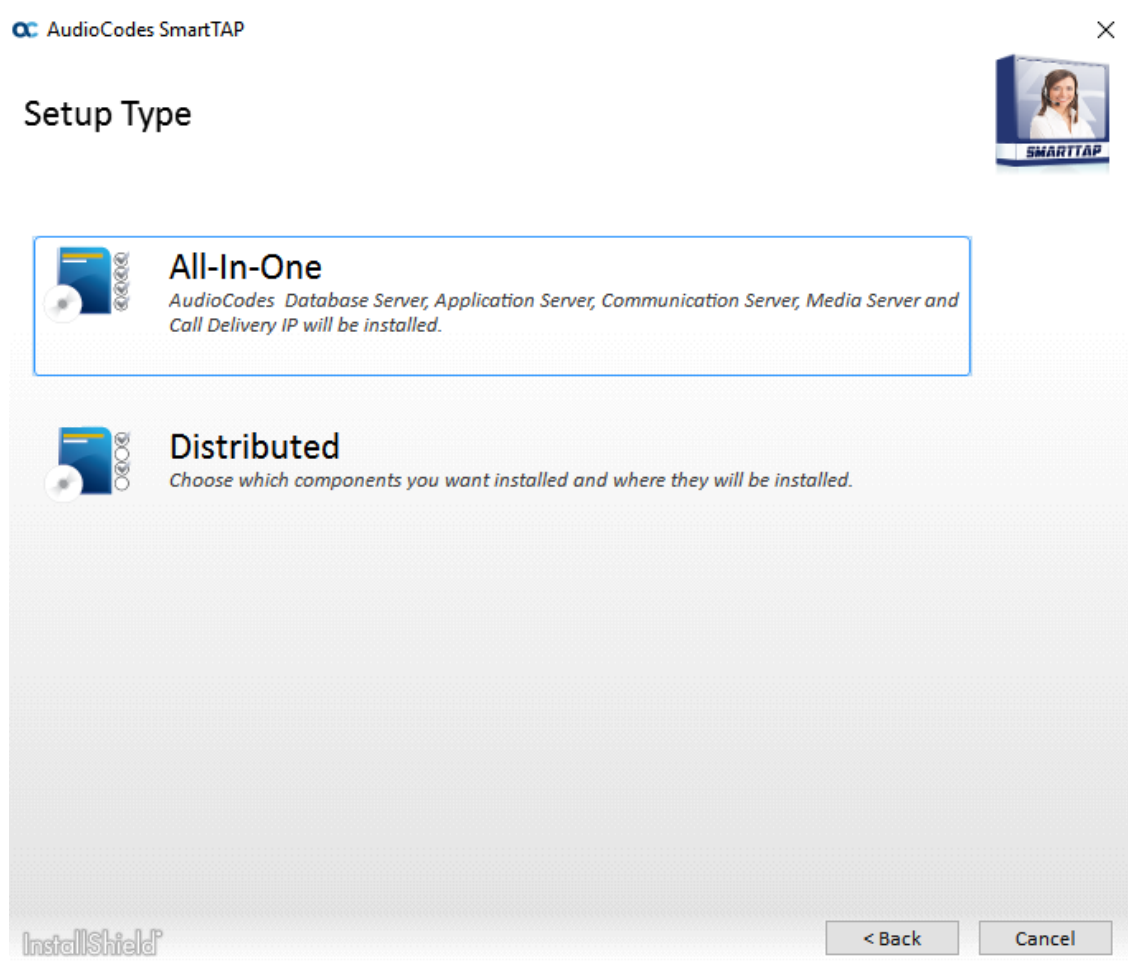
### ➤ To install SmartTAP 360° Live:

1. Verify all prerequisites for the installation are met before moving forward with the installation.
2. Launch install.bat from the “Suite” folder.
3. Click **Next** to continue.

Figure 4-1: Installation Wizard



4. Click **Next** after accepting SmartWORKS license.
5. Click **Next** after accepting SmartTAP 360° Live license.

**Figure 4-2: Setup Type**

6. Select **All-In-One**:

Refer to the following sections:

- Installing Database Service ([Database Service](#) on the next page)
- Installing Application Server (AS) ([Installing the Application Service](#) on page 24)
- Installing Communication Server (CS) ([Installing the Communication Service](#) on page 28)
- Installing the Call Delivery Service (CD) ([Installing the Call Delivery Service](#) on page 29)
- Installing Media Server (MS) ([Installing the Media Server](#) on page 31)
- Installing the Remote Transfer Service ([Installing the Remote Transfer Service](#) on page 32)
- Installing CD-Live component ([Installing CD-Live Component](#) on page 34)





For the installation of these components, unless otherwise specified, accept defaults shown.

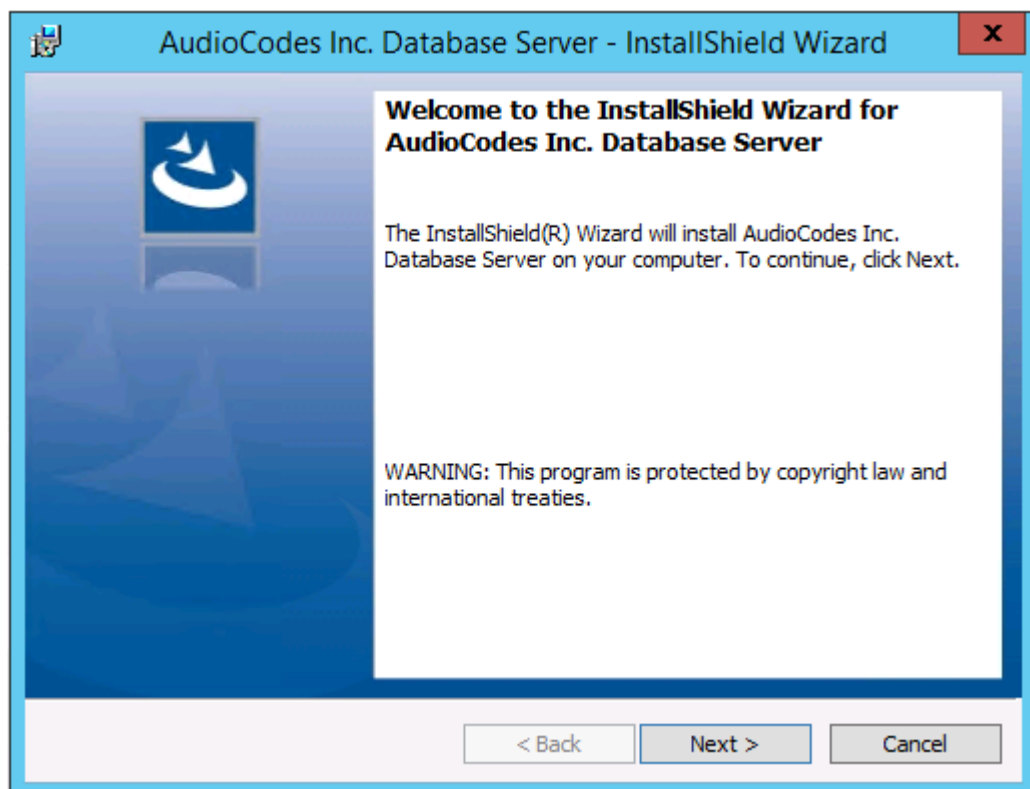
## Database Service

The Database installation starts in the proper sequence when all or multiple services are selected on the installer menu.

### ➤ To install the database service:

1. When the Database Server Installation wizard starts, click Next to install.

Figure 4-3: Database Server Installation Wizard



2. Accept ALL defaults.
3. Click Install.
4. Click **Finish**.
  - For setting up clustered configurations of the database, please contact AudioCodes Technical Support for further information.
  - When upgrading from SmartTAP 1.8.x through SmartTAP 2.2.x, you need to manually check for the following registry key and add it if it is not present:

```
HKLM\SOFTWARE\Wow6432Node\Audiocodes\SmartTAP\DB\InstallDi  
rectory= ...\MySql\MySql Server 5.0\
```

This is a value of type “String”. You must replace the path to MySQL with the real path on the existing system. It is important to leave the trailing backslash in place. Once this is done, the upgrade of the database can proceed successfully.

## Installing the Application Service

The Application Service is essentially a Web server responsible for user access, management and database control.

- The database must be installed before proceeding.
- This procedure also runs a silent installation of the OVOC Main Agent and OVOC Client Agent which are used for sending alarms and status updates to the OVOC Management server. For more information, refer to the *SmartTAP 360° Live Administrator Guide*.

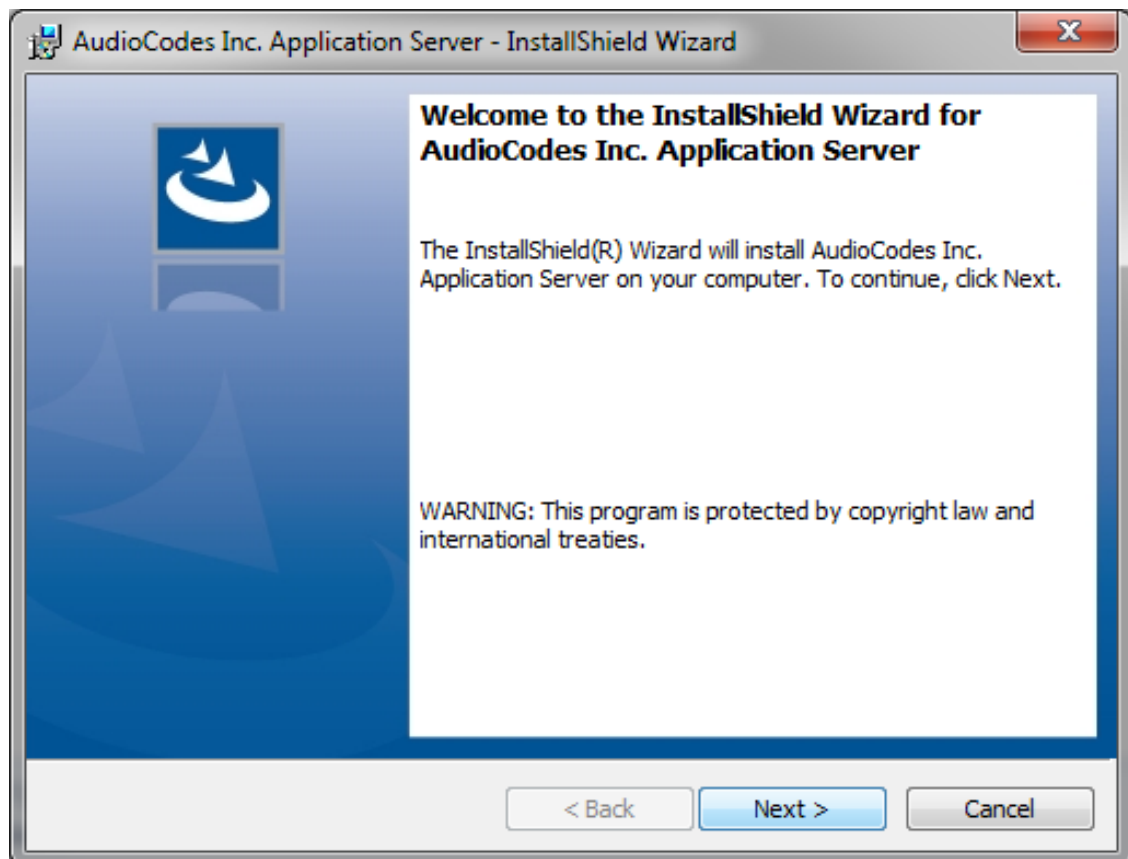


SNMP Trap Service must be disabled on SmartTAP servers running the Application Server component.

### ➤ To install the Application service:

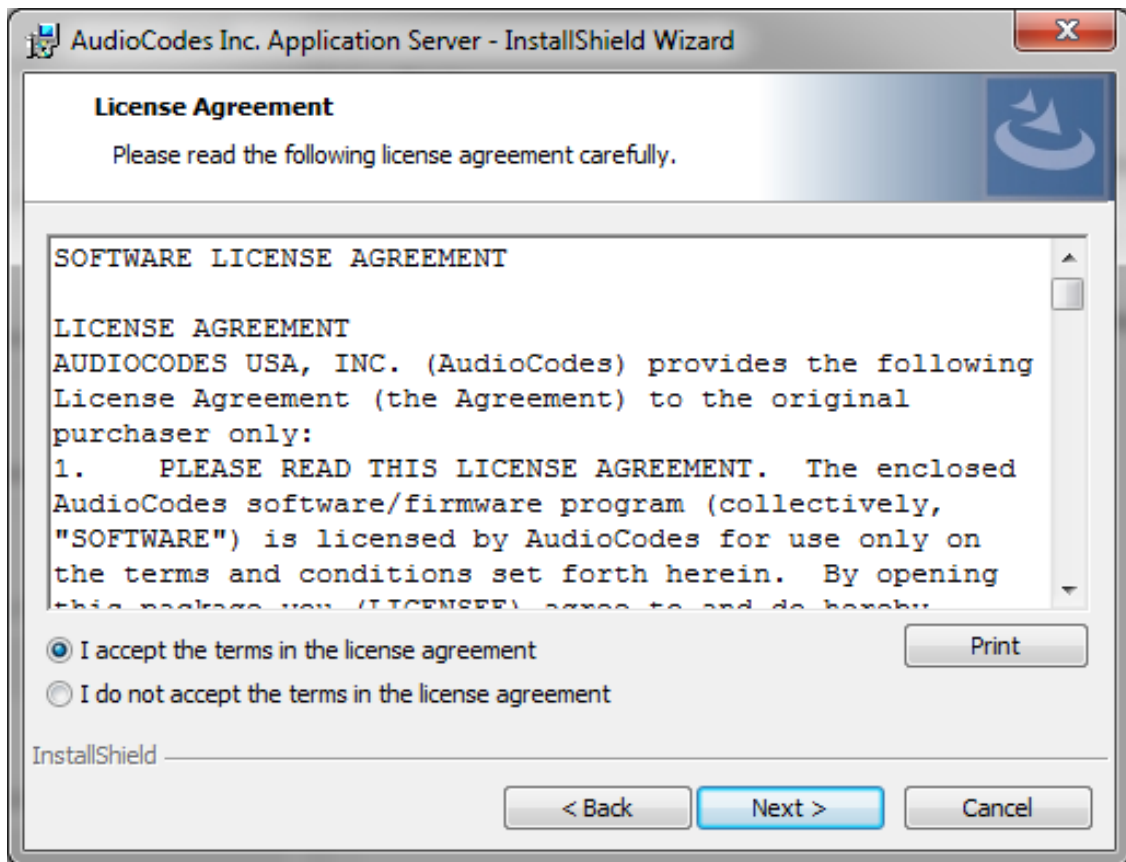
1. The Application Service installation starts in the proper sequence when all or multiple services are selected on the installer menu.
2. When the Application Server installation wizard starts, click **Next** to install.

Figure 4-4: Application Server Installation Wizard



If you are installing from the Suite, then the following screen may not be displayed.

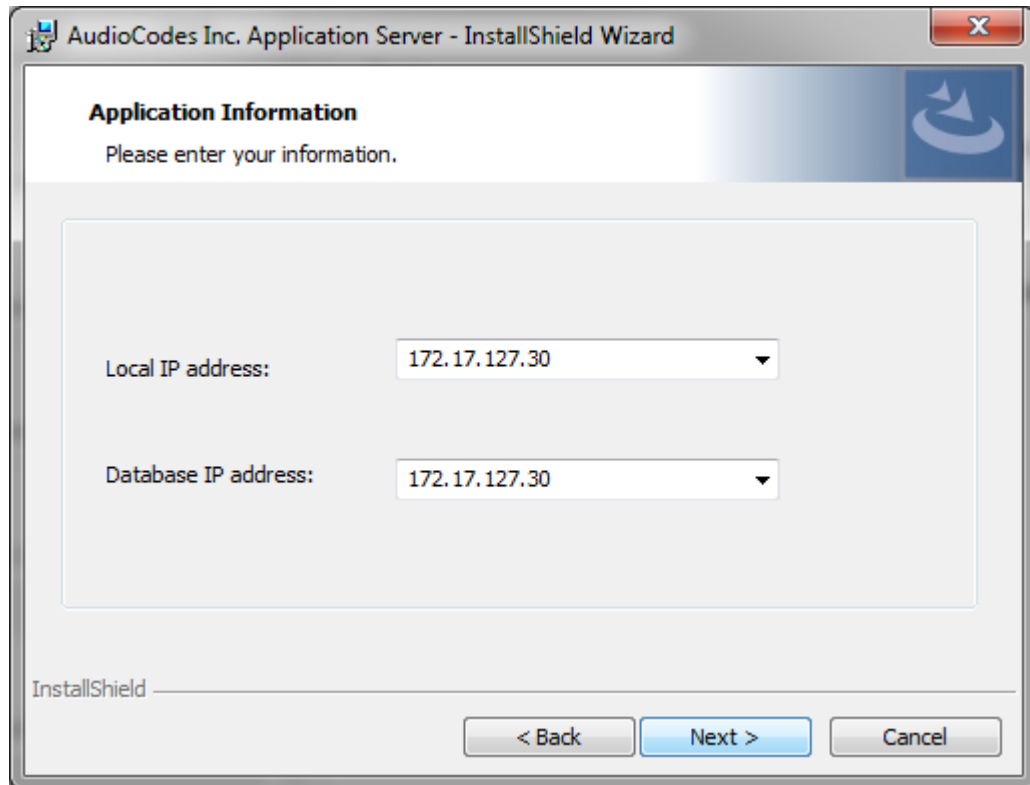
Figure 4-5: License Agreement



3. Select the "I accept the terms in the license agreement" check box and click **Next**.

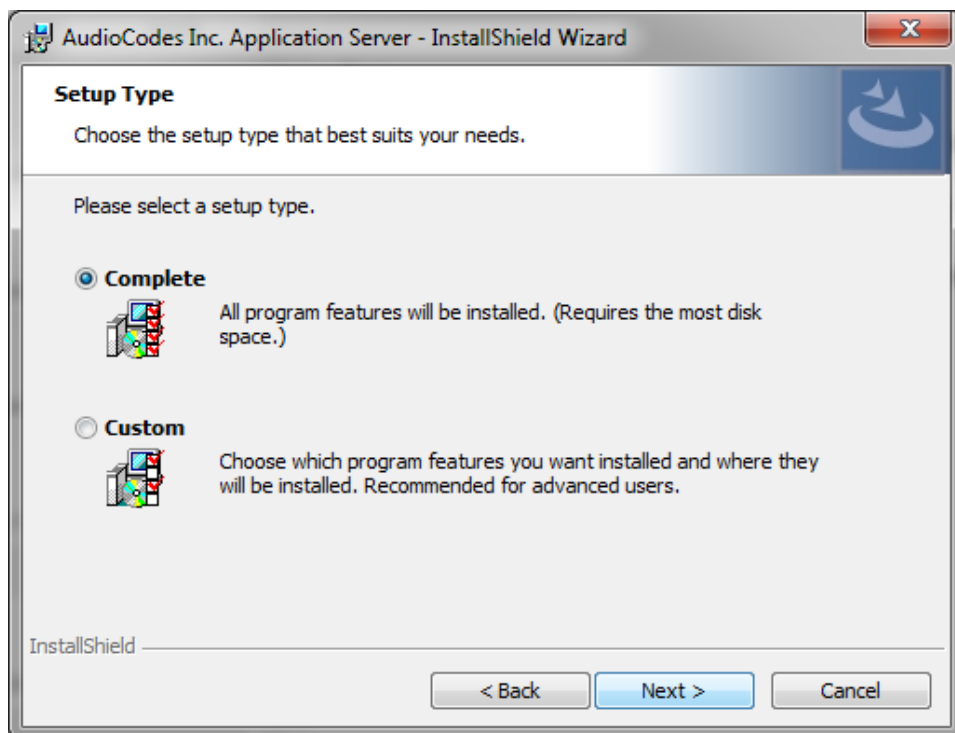
If you are performing an upgrade, the screen below is not displayed.

Figure 4-6: Application Information



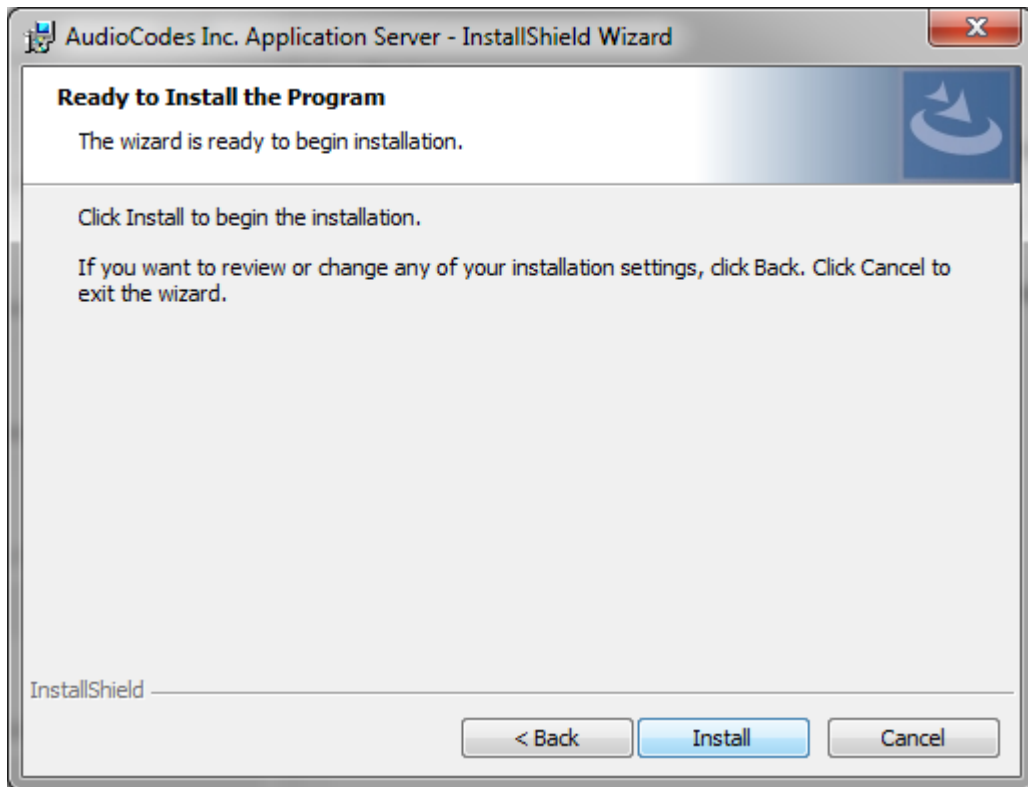
4. Enter the IP address of the Application Server location and the IP address of the Database location. The IP addresses should be external i.e. not the IP address of the local host. Click **Next** to proceed.

Figure 4-7: Setup Type

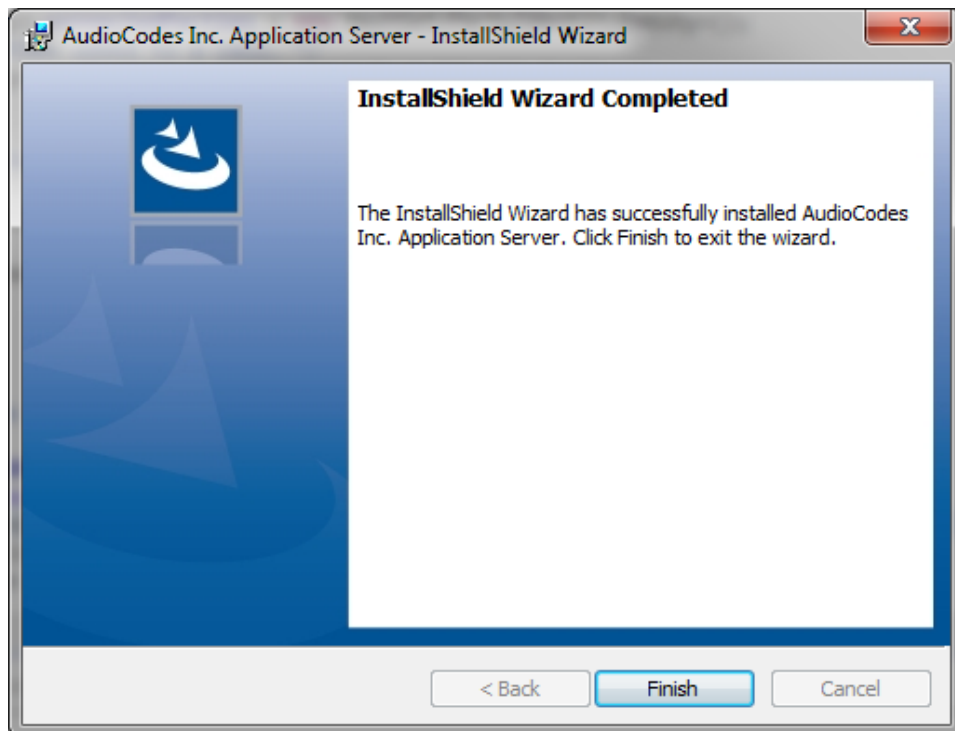


5. Select one of the following setup types and then click **Next**:

- **Complete:** Install to the default location: C:\Program Files\AudioCodes\SmartTAP\AS
- **Custom:** Change the destination location

**Figure 4-8: Ready to Install**

6. Click **Install**.

**Figure 4-9: Complete Installation**

7. Click **Finish**.

## Installing the Communication Service

The Communication Service acts like a SIP proxy and registrar to control connectivity and load balancing between the Call Delivery devices and the Media Servers.



For setting up an HTTPS connection between the SmartTAP Application server and the Communication Service, see [Configuring SmartTAP 360° Live Components for HTTPS](#) on page 167.

### ➤ To install the Communication Service:

1. The database must be installed first before continuing.
2. The Communication Service installation starts in the proper sequence when all or multiple services are selected on the installer menu.
3. When the Communication Server installation wizard starts click **Next** to install.

Figure 4-10: Communication Server



4. Accept ALL defaults.
5. During the installation you are prompted to enter the IP address of the Application server.
6. Click **Install**.
7. Click **Finish**.

## Installing the Call Delivery Service

The Call Delivery is responsible for passively tapping or actively connecting to the telephony environment and then determining which calls to record using the dynamic state machine and target list. A separate Call Delivery Service will be installed for each telephony environment.

The All-In-One SmartTAP install will automatically install the CD-IP Call Delivery for IP PBX recording environments like Skype for Business, Cisco, SIP, NEC, Siemens, etc.

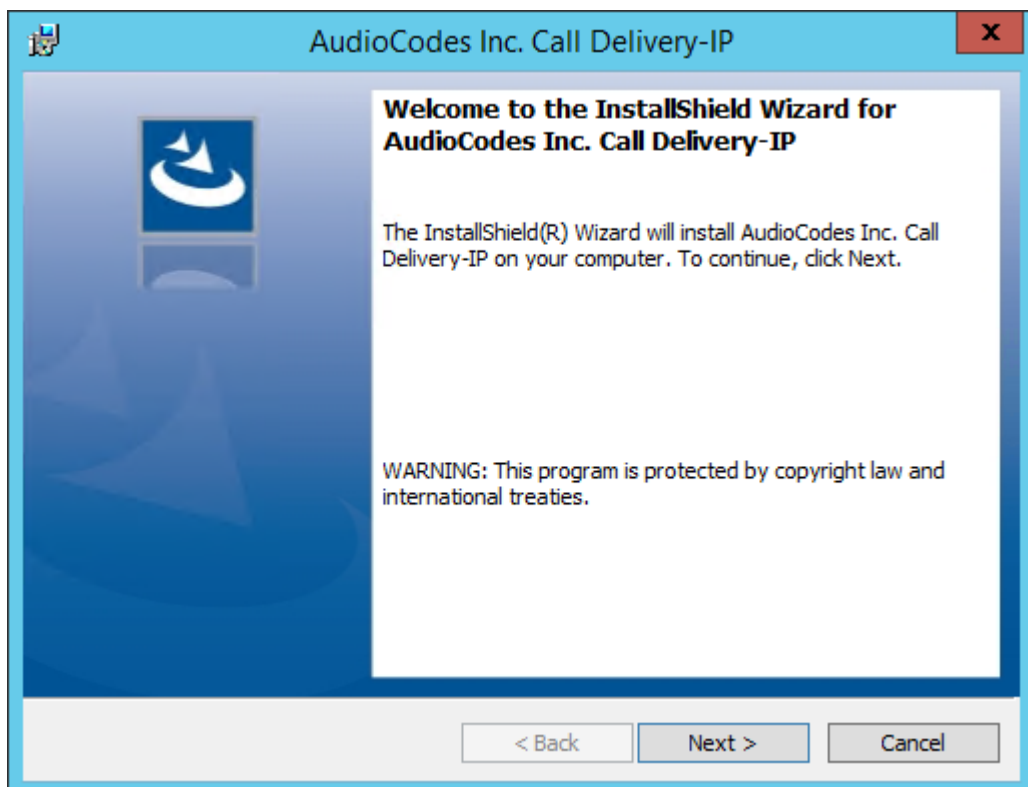


For setting up an HTTPS connection between the SmartTAP Application server and the Call Delivery Service, see [Configuring SmartTAP 360° Live Components for HTTPS](#) on page 167.

➤ **To install the Call Delivery Service:**

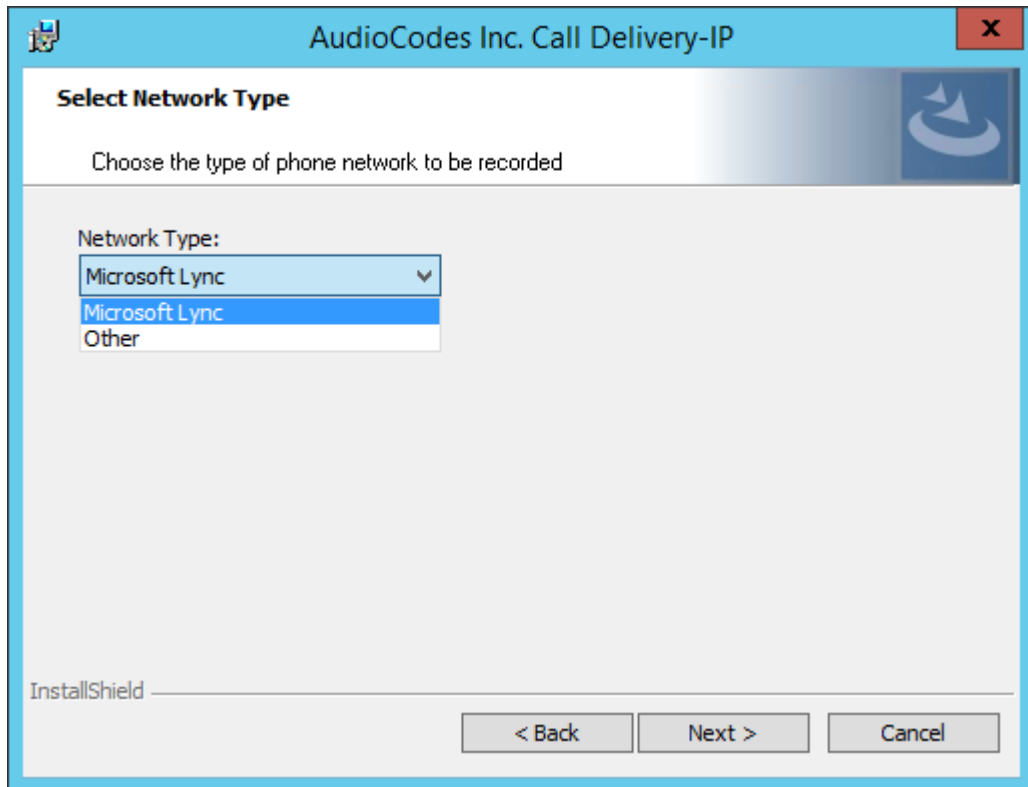
1. When the CallDelivery-IP installation wizard starts click **Next** to install.

Figure 4-11: Call Delivery Service



2. Select Network Integration Type - (Skype for Business or Other).

Figure 4-12: Select Network Type



3. Click **Next**
4. To finish the CD-IP installation, choose one of the following:
  - Skype for Business— See [Installing Call Delivery for Skype for Business \(IP-based Recording\)](#) on page 95
  - Other (VoIP Port Mirror) – See [Call Delivery Install for VoIP \(Port Mirror\)](#) on page 136



After upgrading SmartTAP 360° Live, make sure that the Call Delivery configuration is set to the actual IP address of the servers. Using local host, or 127.0.0.1, will no longer work correctly, although it was valid in previous versions of SmartTAP 360° Live. The “localIp” parameter should be set to the IP address of the Call Delivery server where this software is installed.

The “trapDestIP” and “recorder ip” parameters should be set to the IP address where the Application Server is installed, which may or may not be the same server.

Manually edit this section of the calldeliveryconfig.xml file:

```
<snmp>
  <network localIp="CDRealIP" port="11161" name="SWCallDelivery" oid-
d="1.3.6.1.4.1.5003.9.40.1.1.2" trapDestIp="ASRealIP" />
</snmp>
<applicationServer>
  <recorder ip="ASRealIP" port="80">
    <protocols>
      <protocol>http</protocol>
```



```
</protocols>
</recorder>
</applicationServer>
```

This note applies to CD-IP only.

## Installing the Media Server

The Media Server is responsible for writing to file storage the incoming RTP stream from the Call Delivery, encrypting and compressing the data.

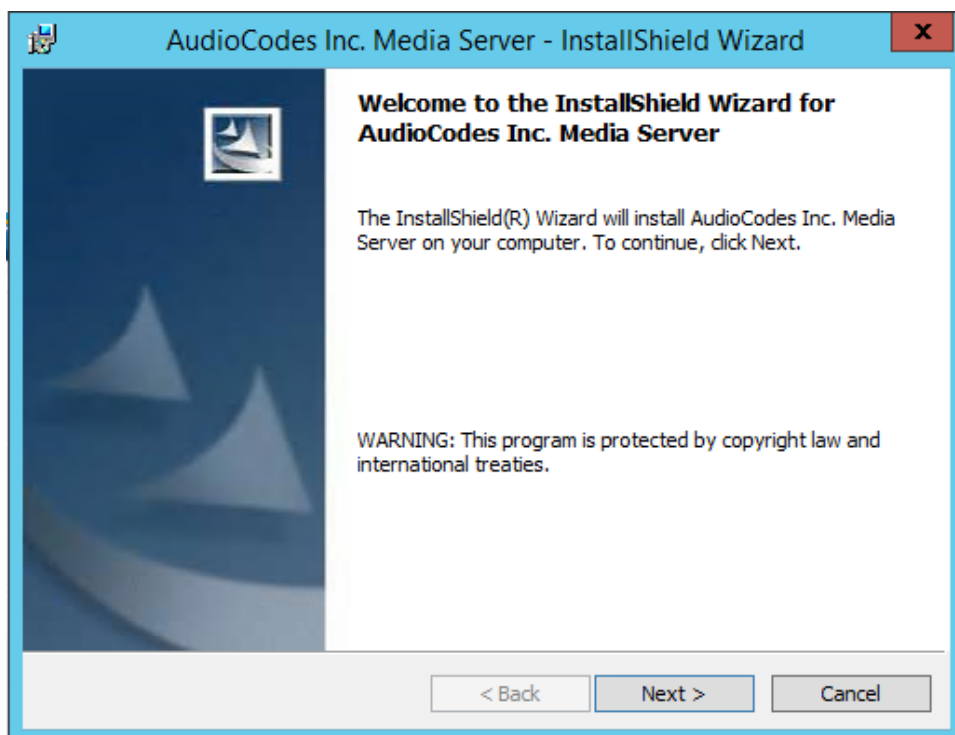


For setting up an HTTPS connection between the SmartTAP Application server and the Media Server, see [Configuring SmartTAP 360° Live Components for HTTPS](#) on page 167

### ➤ To install the Media Server:

1. The Media Server installation starts in the proper sequence when all or multiple services are selected on the installer menu.
2. When the Media Server installation wizard starts, click **Next** to install.

Figure 4-13: Media Server



3. Select the IP Address of the SmartTAP Server from the "Monitoring IP Address" drop-down box.
4. In the Distributed or Remote Branch deployment, enter the real IP address for the Communication and Application Servers.

5. In the all-in-one deployment you can leave the default 127.0.0.1 address or type in the server IP address.

Figure 4-14: Media Server Configuration

**AudioCodes Inc. Media Server - InstallShield Wizard**

**Media Server Configuration**  
Specify the network information in the given fields.

Monitoring IP Address: 172.26.145.14  
This is the IP address that listens for RTP traffic

Communication Server IP Address: 127.0.0.1  
This is the IP address for the Communication Server

Application Server IP Address: 127.0.0.1  
This is the IP address for the SNMP trap destination

REMINDER: Host and edge firewall rules may require updating to pass RTP traffic. Also, make sure to re-check your Windows firewall settings after installing Windows Updates.

InstallShield

< Back   Next >   Cancel

6. Click **Next**.
7. Click **Install**.
8. Click **Finish**.

## Installing the Remote Transfer Service

This section describes how to install the Remote Transfer Service (RTS).

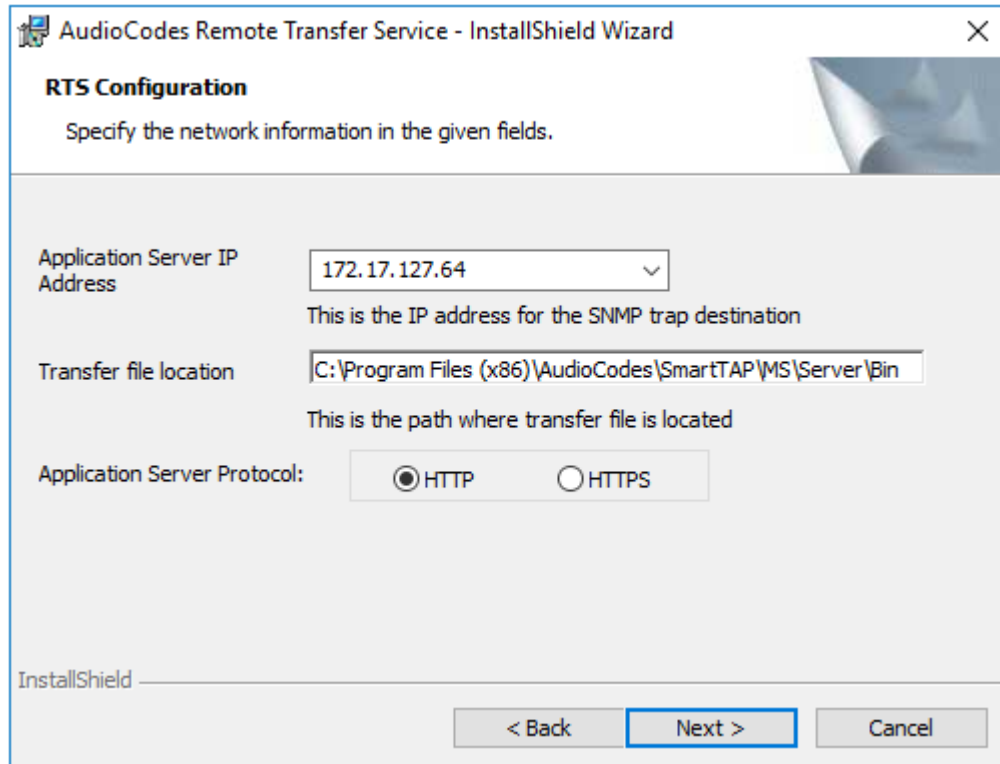


The installation script installs Microsoft .NET Framework Version 4.7.

### ➤ To install the RTS:

1. The RTS installation starts in the proper sequence when all or multiple services are selected on the installer menu.
2. When the RTS installation wizard starts, click **Next** to install.

Figure 4-15: RTS Configuration



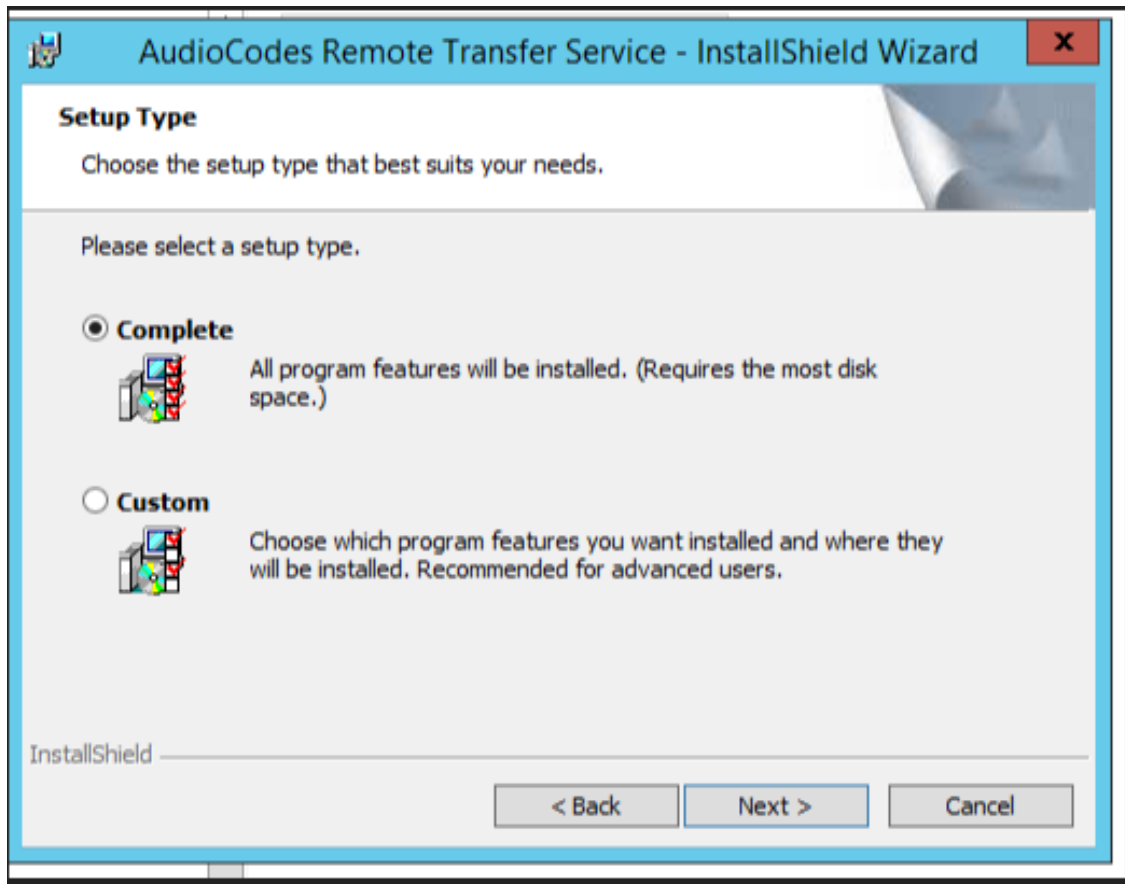
The screenshot shows a window titled "AudioCodes Remote Transfer Service - InstallShield Wizard" with a close button in the top right corner. The main heading is "RTS Configuration" with the instruction "Specify the network information in the given fields." Below this, there are three configuration fields:

- Application Server IP Address:** A dropdown menu showing "172.17.127.64". Below it, the text reads "This is the IP address for the SNMP trap destination".
- Transfer file location:** A text box containing "C:\Program Files (x86)\AudioCodes\SmartTAP\MS\Server\Bin". Below it, the text reads "This is the path where transfer file is located".
- Application Server Protocol:** Two radio buttons are present: "HTTP" (which is selected) and "HTTPS".

At the bottom left, the "InstallShield" logo is visible. At the bottom right, there are three buttons: "< Back", "Next >" (which is highlighted with a blue border), and "Cancel".

3. Enter the following parameters and then click **Next**:
  - Application Server IP address
  - Transfer File Location (Location of Bin folder of installed MS component)
  - Application Server Protocol (HTTP or HTTPS)

Figure 4-16: Setup Type



4. Click **Next** to complete the installation.

## Installing CD-Live Component

The CD-Live component is responsible for the Instant Message Chats Recording. This component must be installed on the Azure machine that matches the Key Vault's Access Policy and that has been enabled with Identity. For details, see *Configure Azure for Instant Messaging Recording Application* in the *SmartTAP 360° Live Installation Manual*.

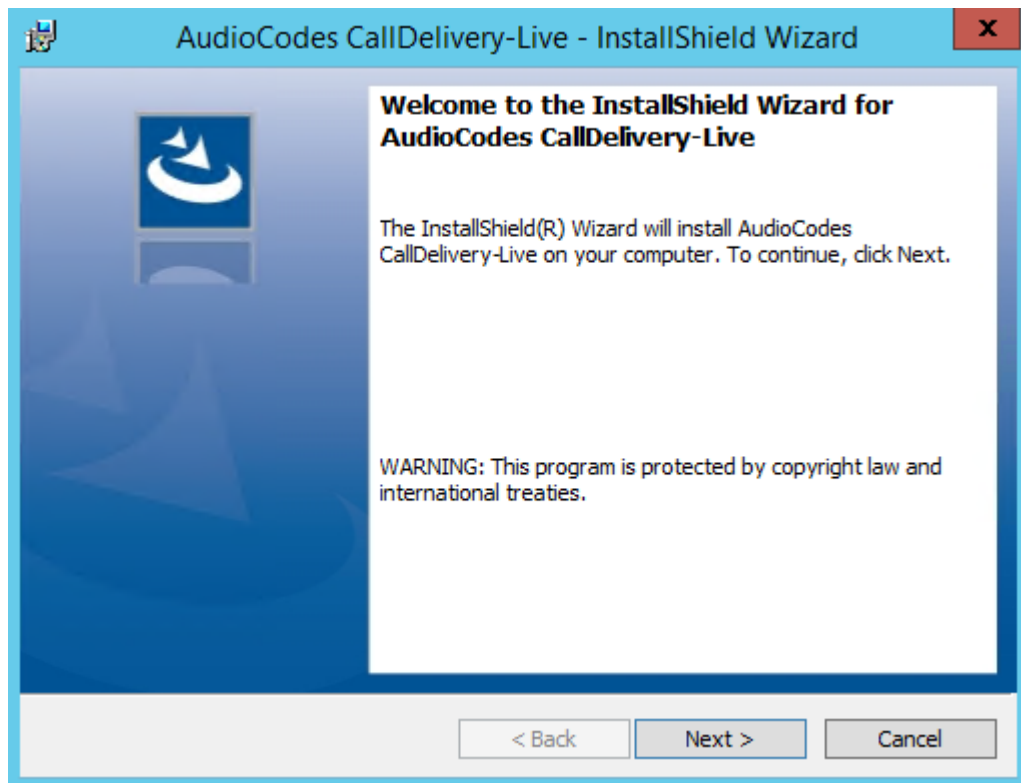


The CD-Live component must be installed either as a component of the SmartTAP server on Azure or on a Stand alone server on Microsoft Azure. It cannot be installed On-premises.

### ➤ To install the CD-Live component:

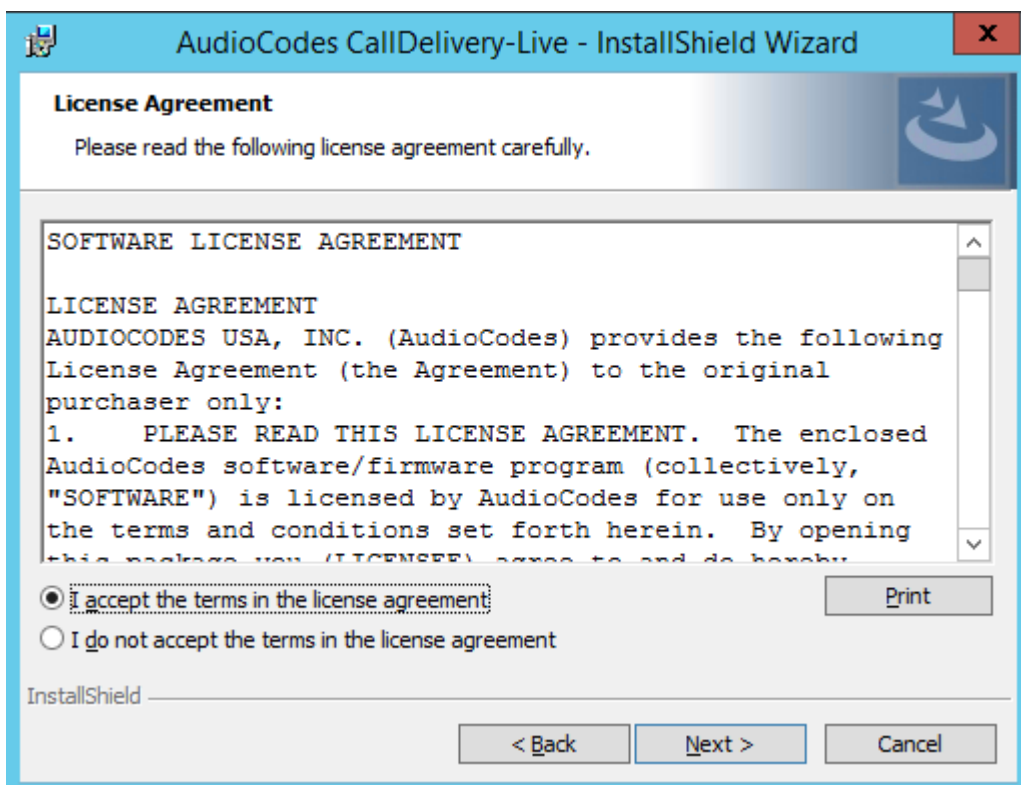
1. When the CD-Live installation wizard starts click **Next** to install.

Figure 4-17: Welcome to Call Delivery Live



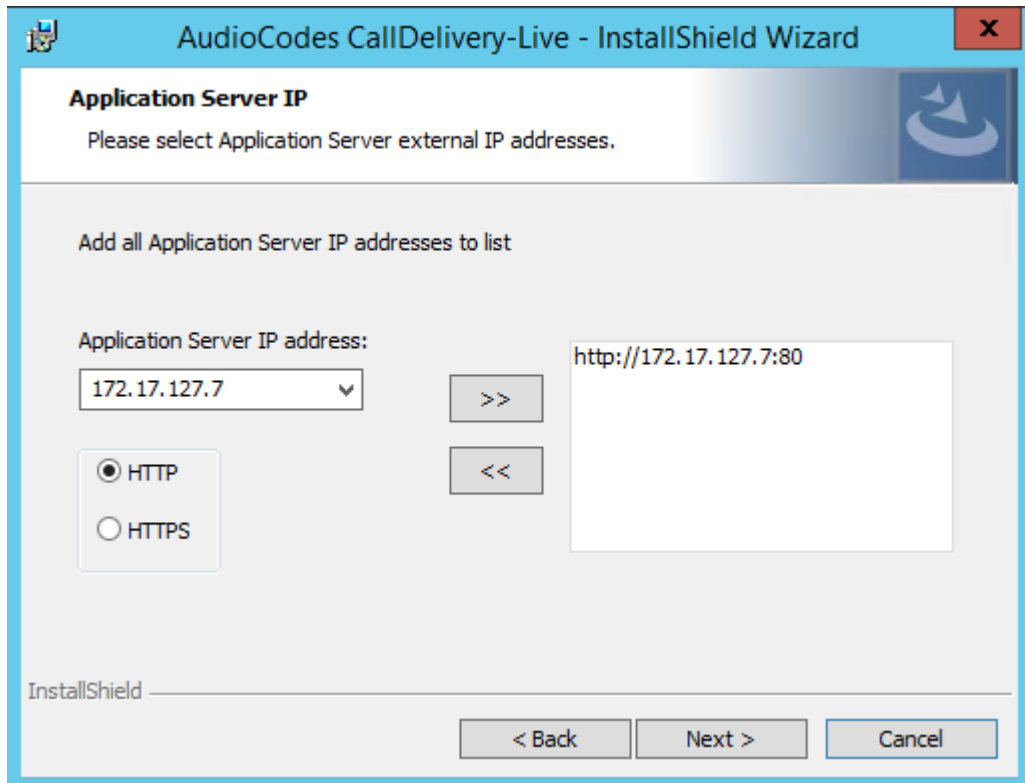
2. Accept the License Agreement and click **Next**.

Figure 4-18: License Agreement



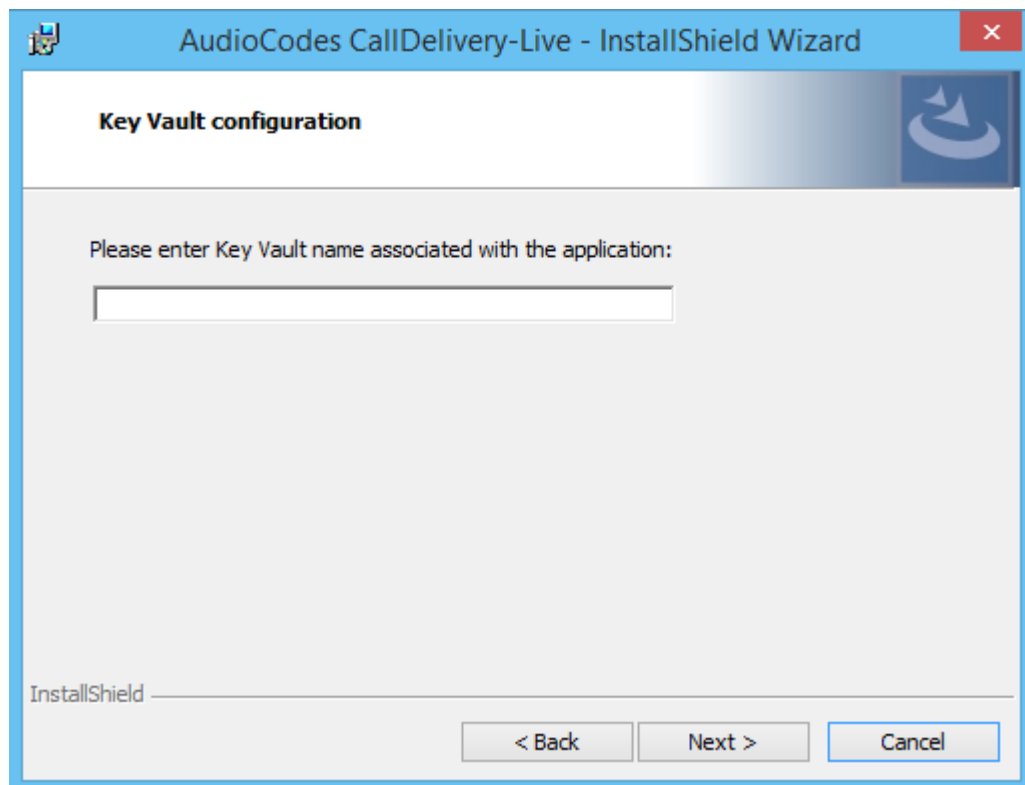
3. Enter the Application Server IP Address and configure HTTP/HTTPS as required.

Figure 4-19: Application Server IP Address



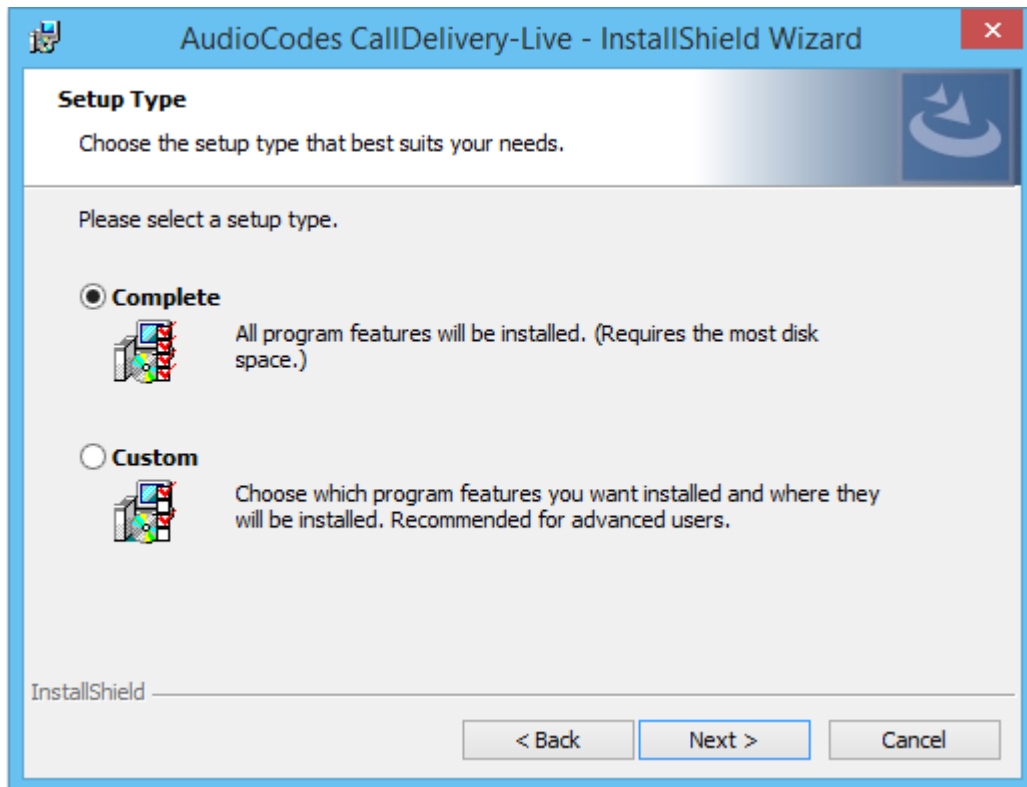
4. Add the Azure Key Vault name that was created in Section .... and then click **Next**.

Figure 4-20: Key Vault Configuration



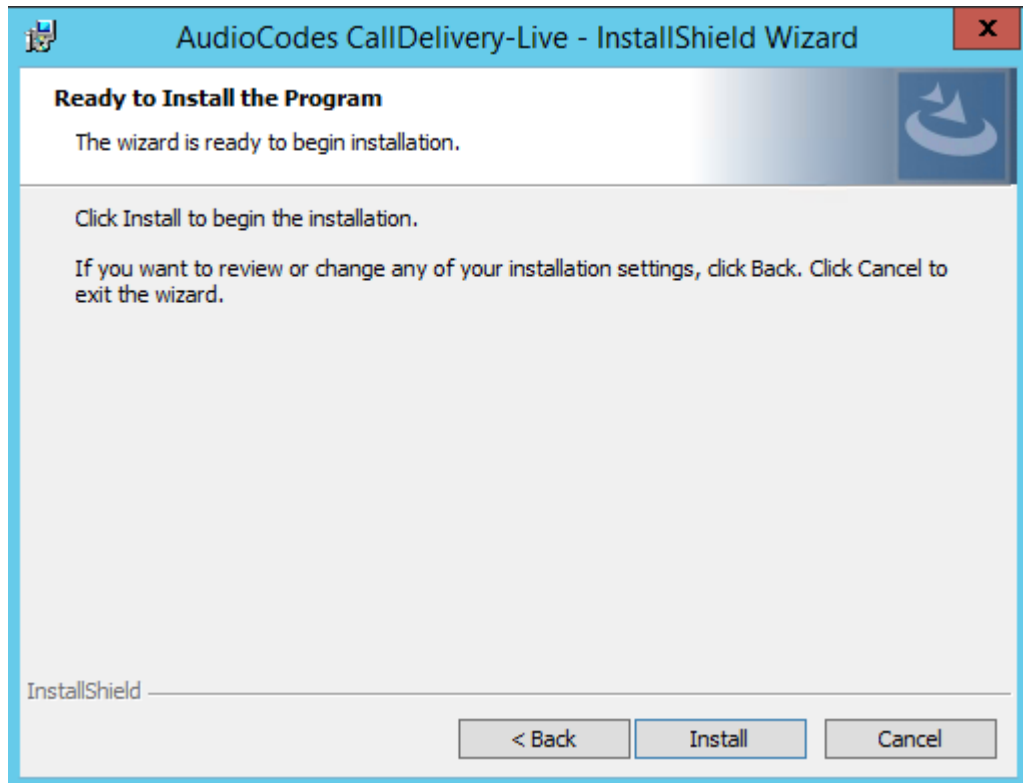
5. Select one of the following setup types and then click **Next**:

- **Complete:** Install to the default location: C:\Program Files\AudioCodes\SmartTAP\AS
- **Custom:** Change the destination location

**Figure 4-21: Setup Type**

6. Click **Install**.

Figure 4-22: Ready to Install



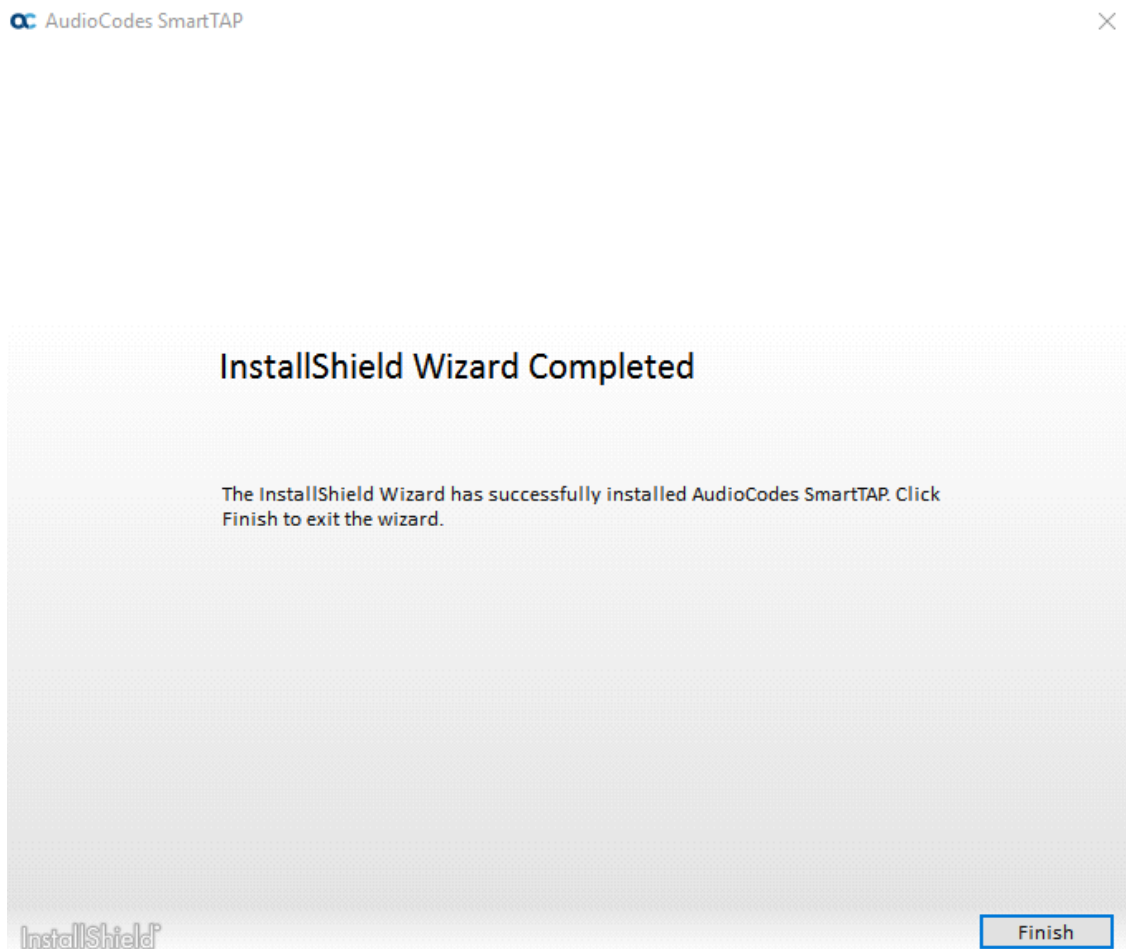
CD-Live will receive its Secrets from Azure and Targets from AS.

## Completing Wizard Installation

When the installer completes the installation of all the software components, a dialog window appears indicating that the installation has completed.

1. When the installer completes the following screen appears:



**Figure 4-23: InstallShield Wizard Completed**

2. Click **Finish** to exit the installer.
3. Proceed to [Integration Configuration](#) on page 135 to complete the integration configuration steps required before the server is ready to record calls.

## Post-Installation Integration

At this point in the installation, the software is running on the server. However, the SmartTAP 360° Live recorder needs additional integration specific configuration before it is capable of recording calls. This integration is described in Chapter [Integration Configuration](#) on page 135.

## 5 Installation Wizard - Distributed Method

This Chapter describes the Distributed method for installing SmartTAP 360° Live.

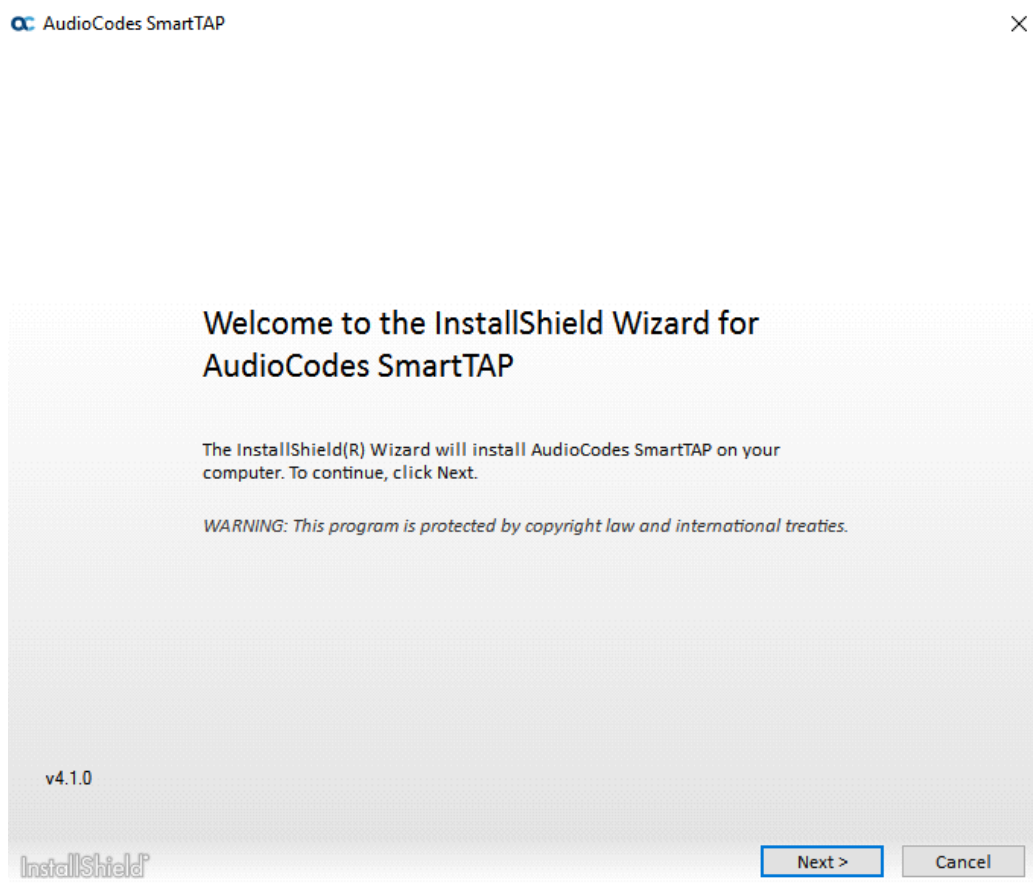


- This installation method assumes that each SmartTAP 360° Live component will be installed on a separate physical or virtual server.
- If you are running a clean installation or upgrade, you may be prompted to restart the server. In this case, the installer prompts for a server restart; perform this action and then upon completion, run the installation script again.

➤ **To install the distributed method:**

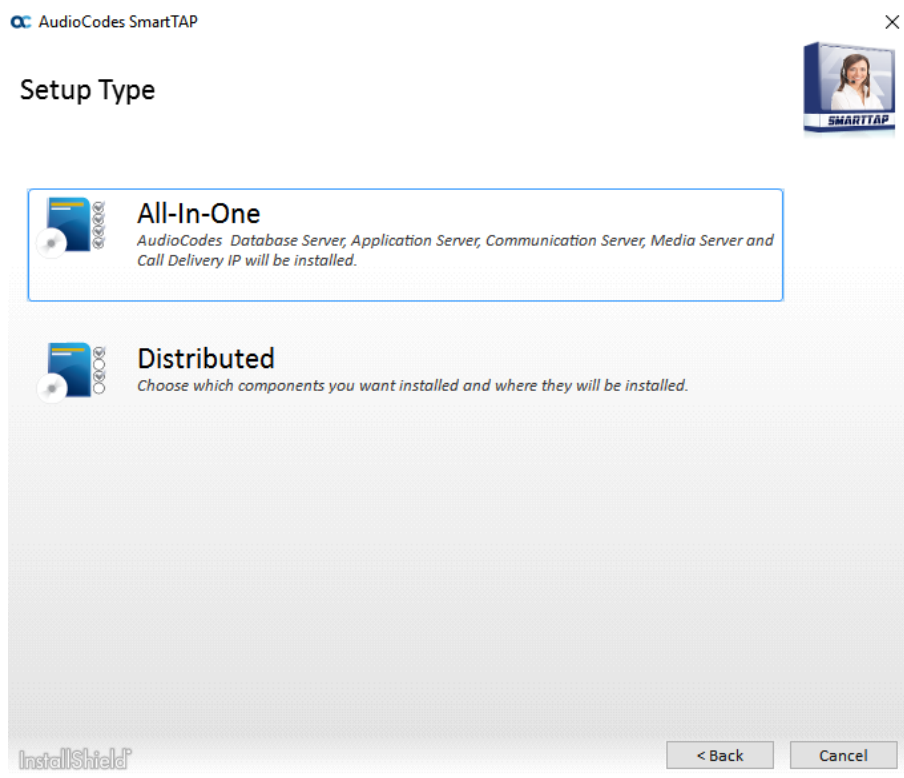
1. Launch install.bat from the “Suite” folder.
2. Click **Next** to continue.

**Figure 5-1: InstallShield Wizard SmartTAP**



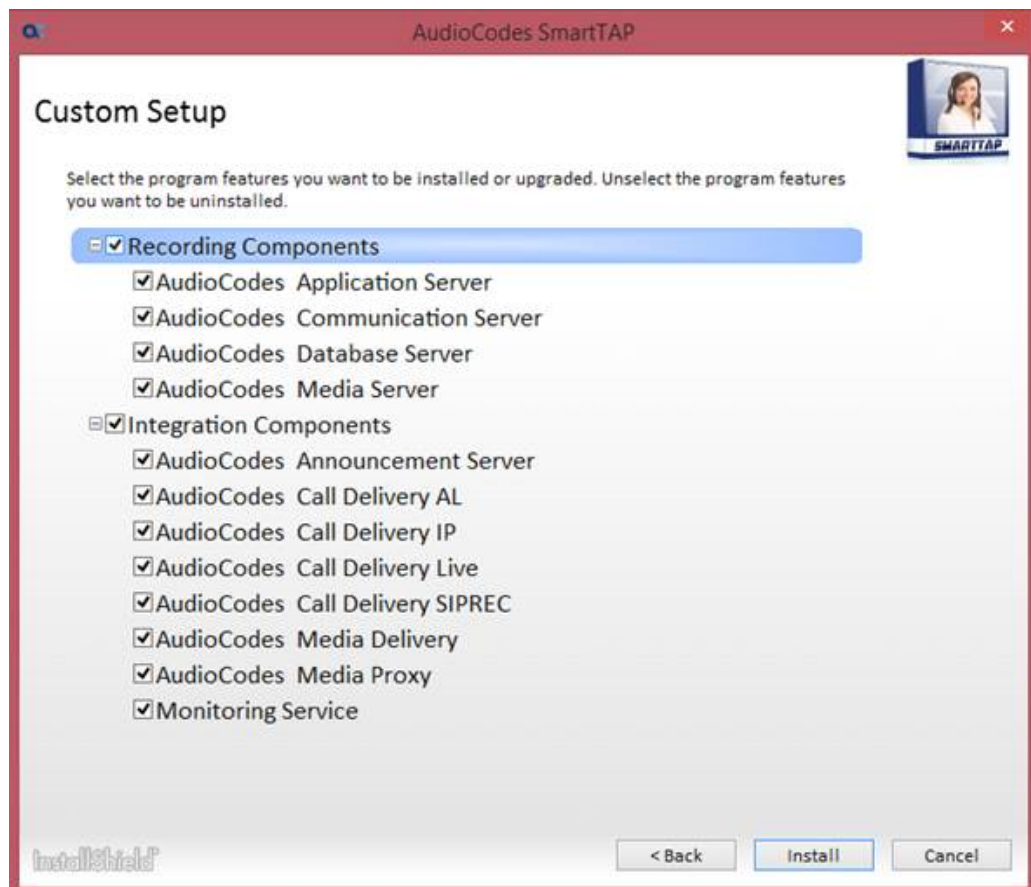
3. Click **Next** after accepting SmartWORKS license.
4. Click **Next** after accepting SmartTAP license.

Figure 5-2: Setup Type



- 5. Select the Distributed installation option.

Figure 5-3: Custom Setup



6. Select the software elements that you wish to install. Refer to the following sections:
  - Installing SmartTAP Database Server ([Installing SmartTAP Database Server](#) below)
  - Installing SmartTAP 360° Live Application Server Installation ([Installing SmartTAP 360° Live Application Server](#) on the next page)
  - Installing SmartTAP 360° Live Communication Server ([Installing SmartTAP Communication Server](#) on the next page)
  - Installing SmartTAP 360° Live Media Server ([Installing SmartTAP Media Server](#) on page 44)
  - Installing SmartTAP 360° Live Call Delivery Server ([Installing SmartTAP Call Delivery Server](#) on page 51)

## Installing SmartTAP Database Server

This section describes the database service software installation.



It is highly recommended to configure the Firewall with the required ports to ensure proper communication prior to the software installation. See [Firewall Configuration](#) on page 59.

### ➤ To install the database service software:

1. Run the Install.bat from the SmartTAP “Suite\” folder.
2. Select the Distributed software Custom Setup type.
3. Select the AudioCodes Inc. Database Server option.
4. Click **Install**.
5. Click **Next** to continue.
6. Select Complete, and then click **Next** to continue.
7. Click **Install**.
8. Click **Finish** to complete the installation.

## Database Service Configuration

The database is configured automatically during the installation of the AS.

## Installing SmartTAP 360° Live Application Server



- During an upgrade of the Application Server, the installers may mistakenly stop and ask the user to choose between a “Complete” and “Custom” installation. If the component was installed to a custom location, make sure the correct location is still set in the “Custom” dialog box.”
- It is highly recommended to configure the Firewall with the required ports to ensure proper communication prior to the software installation. See [Firewall Configuration](#) on page 59
- This procedure also runs a silent installation of the OVOC Main Agent and OVOC Client Agent that are used to manage alarms and status updates that are sent to OVOC management server. Refer to the SmartTAP Administrator Guide.

### ➤ To install the Application Service:

1. Verify that the (DB) Database Server is installed and the MySQL service is running.
2. Run the Install.bat from the SmartTAP “..\Suite\” folder.
3. Select the Distributed software Custom Setup type.
4. Select the AudioCodes Inc. Application Server option.
5. Click **Next**.
6. Change the Database Server IP from "127.0.0.1" to the IP of the Database Server.
7. Click **Next**.
8. Select **Complete**, and then click **Next** to continue.
9. Click **Install**.
10. Click **Finish** to complete the installation.

## Installing SmartTAP Communication Server



- During an upgrade of the Communication Server, the installers may mistakenly stop and ask the user to choose between a “Complete” and “Custom” installation. If the component was installed to a custom location, make sure the correct location is still set in the “Custom” dialog box.”
- It is highly recommended to configure the Firewall with the required ports to ensure proper communication prior to the software installation. See [Firewall Configuration](#) on page 59

### ➤ To install the Communication Server:

1. Run the Install.bat from the SmartTAP “Suite\” folder.
2. Select the Distributed software Custom Setup type.
3. Select the AudioCodes Inc. Communication Server option.

4. Click **Install** button to continue.
5. Click **Next** to continue.
6. Enter the "Application Server Name or IP" when prompted.
7. Enter the "Media Server Name or IP" when prompted.
8. Enter the "Database Server Name or IP" when prompted.
9. Since the Master DB is remote, the CS installation will install a local Slave DB with the CS.
10. The Slave DB will automatically connect to the Master DB.
11. Select Complete, and then click **Next** to continue.
12. Click **Install**.
13. Click **Finish** to complete the installation.

## Installing SmartTAP Media Server



- The transfer of the media files between the Media Server, Application Server, and File Server (SAN/NAS) is accomplished by using the windows SHARE (SMB) facilities. Therefore, all servers must be part of the same windows domain.
- It is highly recommended to configure the Firewall with the required ports to ensure proper communication prior to the software installation. See [Firewall Configuration](#) on page 59.

### ➤ To install the Media Server:

1. Run the Install.bat from the SmartTAP "Suite\" folder.
2. Select the Distributed software Custom Setup type.
3. Check on AudioCodes Inc. Media Server option.
4. Click **Install** to continue.
5. Click **Next** to continue.
6. Select the Monitoring IP Address from the drop-down list.
  - Typically the IP of the physical or virtual server.
  - The Monitoring IP Address is the IP address of the interface that listens for the RTP media to be recorded. This RTP media is sent from the Call Delivery Server, Media Delivery or Media Proxy depending upon deployment solution.
7. Enter the Communication Server IP Address when prompted.
8. Enter the Application Server IP Address when prompted.
9. Select Complete, and then click Next to continue.
10. Click **Install** to continue.
11. Click **Finish** to complete the installation.

## Media Server Configuration



This procedure is not relevant if the media files are stored on the same server as the Media Server.

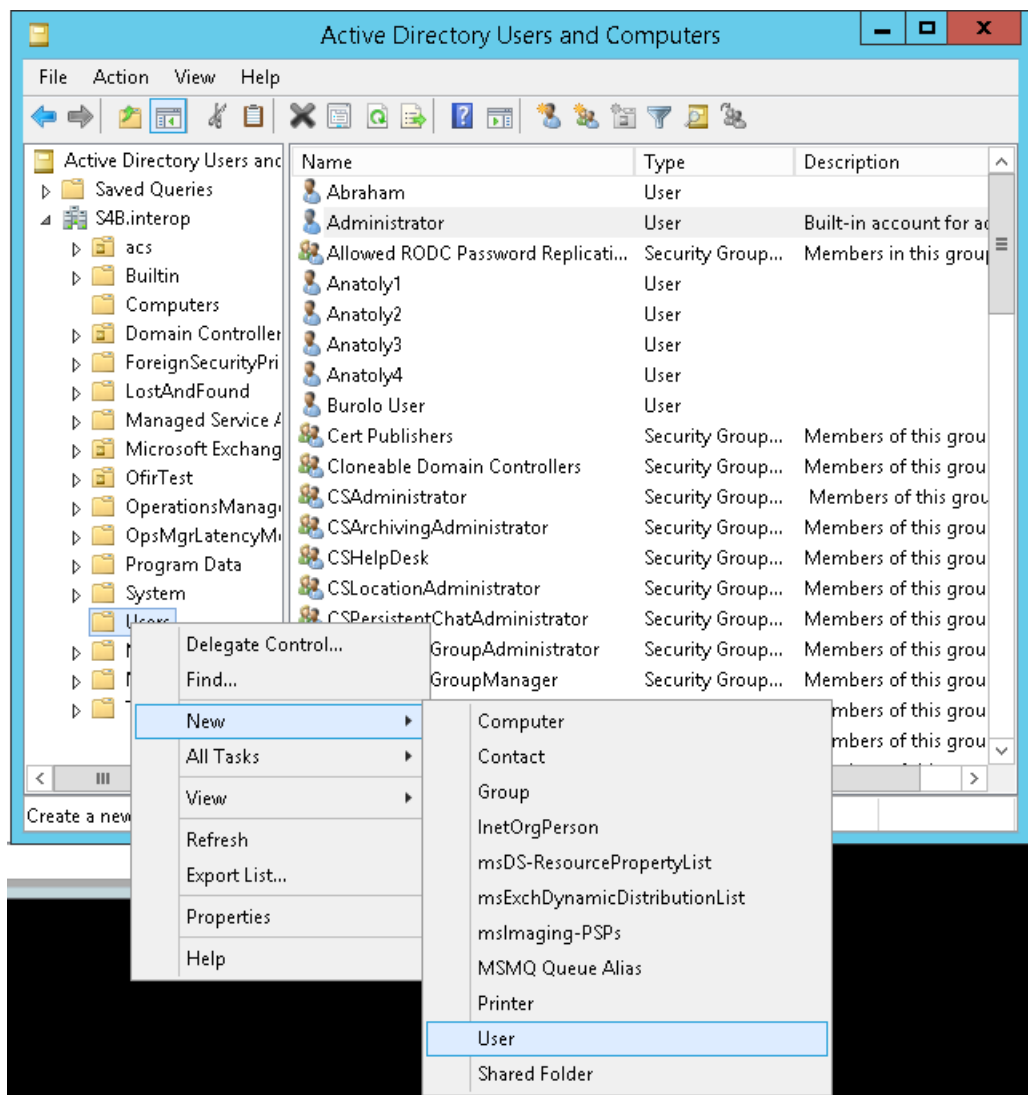
## Network File Server

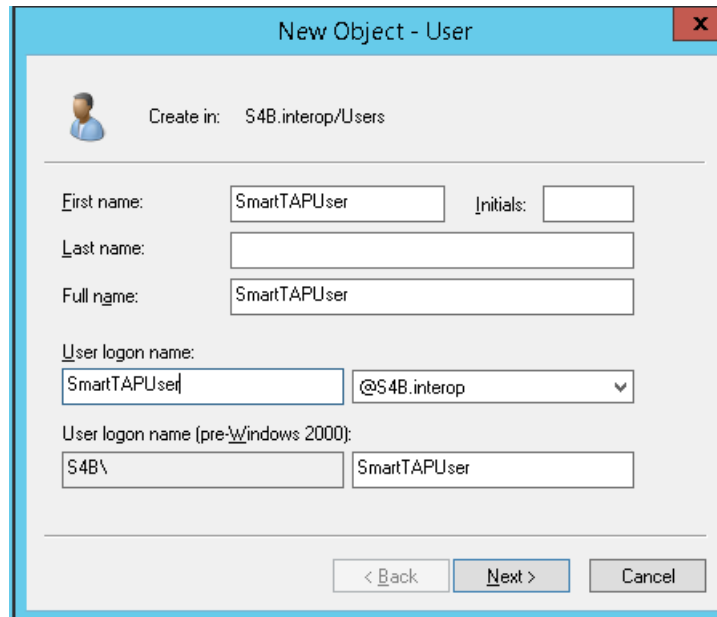
This section describes how to create a user account for SmartTAP 360° Live on the domain. For example “SmartTAPUser” for the Network File server.

### ➤ To setup the network file server accounts:

1. In the Active Directory Users and Computers folder, select the Users folder and then right-click **New** > **User**.

**Figure 5-4: Active Directory Users and Computers**



**Figure 5-5: New SmartTAP 360° Live User**

**New Object - User**

Create in: S4B.interop/Users

First name: SmartTAPUser Initials:

Last name:

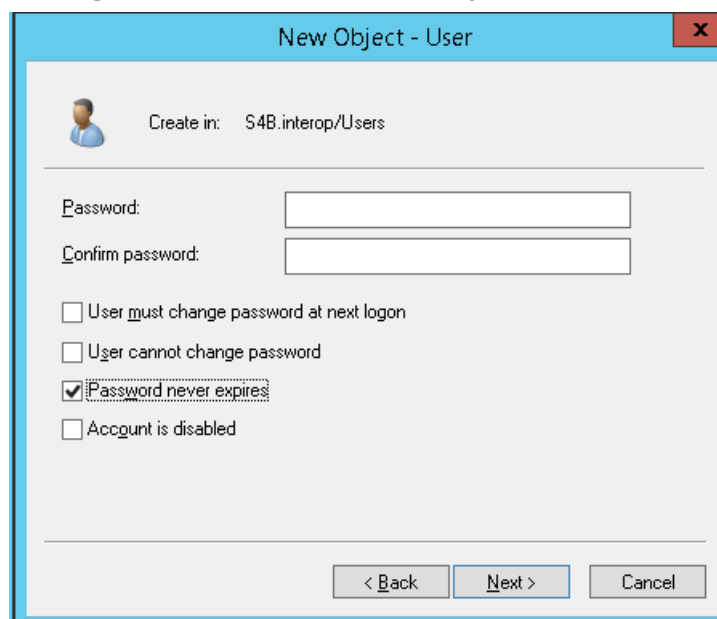
Full name: SmartTAPUser

User logon name: SmartTAPUser @S4B.interop

User logon name (pre-Windows 2000): S4B\ SmartTAPUser

< Back Next > Cancel

2. Enter the name of the SmartTAP 360° Live user in the First Name and User logon name fields and click **Next**.

**Figure 5-6: Password Never Expires**

**New Object - User**

Create in: S4B.interop/Users

Password:

Confirm password:

User must change password at next logon

User cannot change password

Password never expires

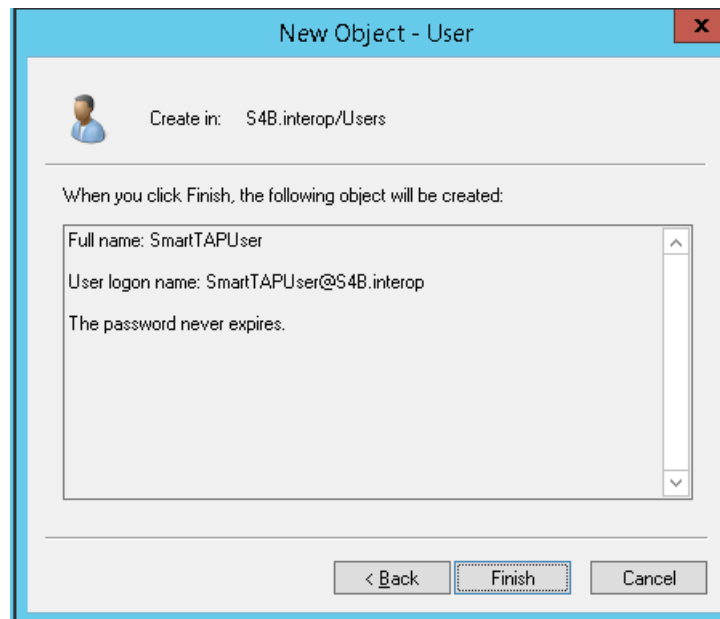
Account is disabled

< Back Next > Cancel

3. Enter a password, select the “Password never expires” check box and click **Next**.

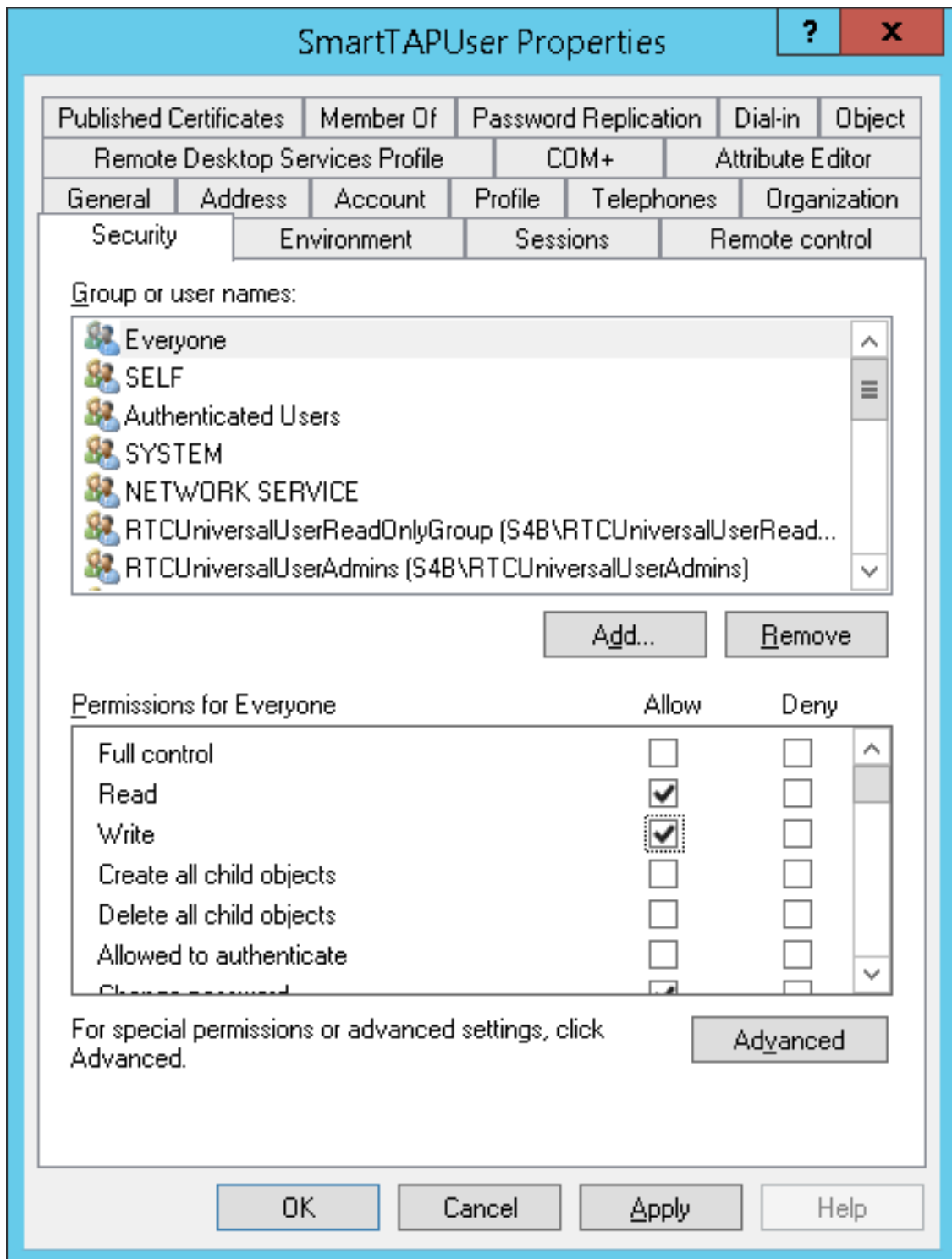
The following confirmation dialog is displayed:



**Figure 5-7: User Add Confirmation**

4. Click **Finish**.
5. Right-click the newly created user, choose Properties and click the **Security** tab.

Figure 5-8: Assign Read and Write Permissions



6. Assign "Read" and "Write" permissions and click **OK**.
7. Log in to the Media server as user "SmartTAP 360° Live".
8. Access the SmartTAP 360° Live shared media storage in the File server.
9. Create, edit, and delete a test file in the storage directory.
10. Log off.

## Media Server

This section describes how to add the SmartTAP domain user to the local Administrators Group and to assign it to the SmartTAP Remote Transfer Service.

### ➤ Do the following:

1. Add SmartTAP user to local Administrators Group:
  - a. In the Active Directory Users and Computers, right-click the newly created SmartTAP user and choose Add to a group.

**Figure 5-9: Add SmartTAP user to Administrators Group**

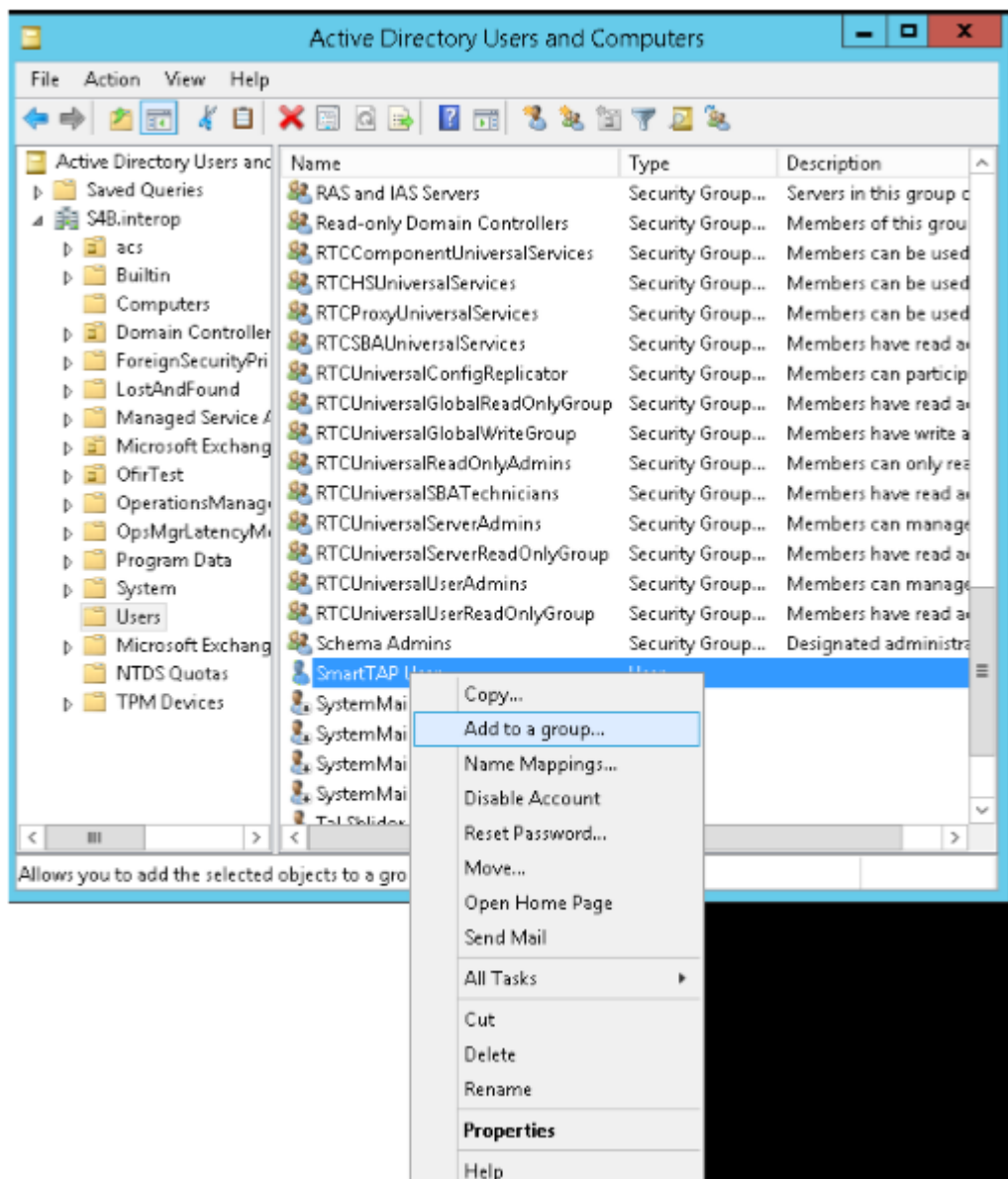
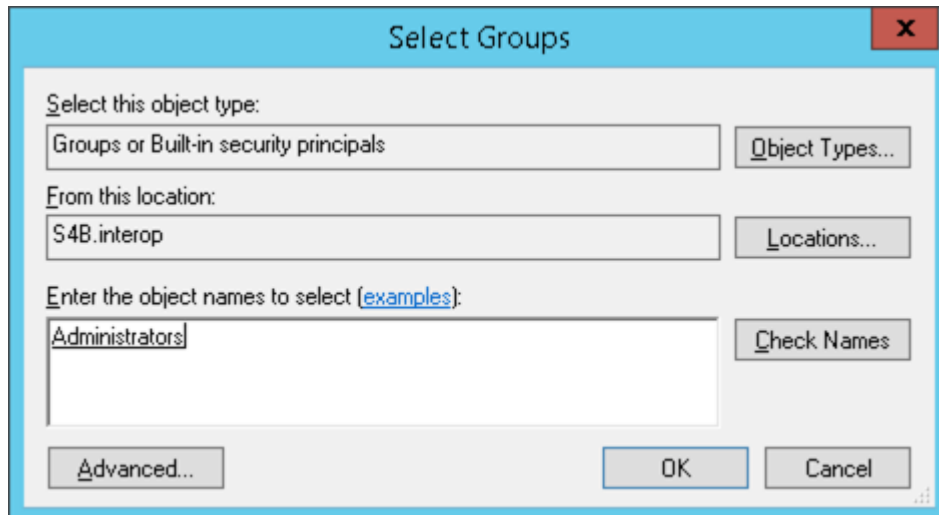


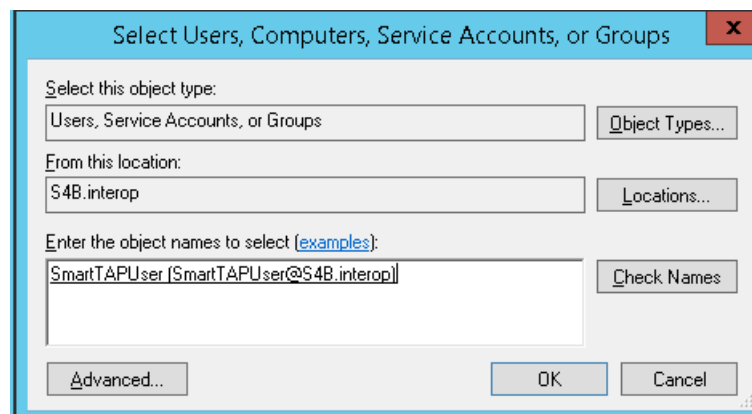
Figure 5-10: Add Smart TAP User to Administrator



- b. Enter Administrator and then click Check Names. The successfully recognized entry is underlined.
    - c. Click **OK**. A confirmation screen is displayed.
  2. Assign the SmartTAP user to the AudioCodes MS-TR service:
    - a. Open the Services (Local) application (services.msc).
    - b. Select the service “SmartTAP MS-TR”, right-click Properties and click the Logon tab.
    - c. Select the ‘This account’ check box.
    - d. Click Browse to search for the domain user who has permissions for the shared media directory in the file server.

This user may be the SmartTAP user or any other user defined for this purpose.

Figure 5-11: Assign User to SmartTAP MS-TR Service Account



- e. Click **Check Names**. The successfully recognized entry is underlined.
      - f. Restart the service.

## Installing SmartTAP Call Delivery Server



It is highly recommended to configure the Firewall with the required ports to ensure proper communication prior to the software installation. See [Firewall Configuration](#) on page 59.

### ➤ To Install the Call Delivery server:

1. Run the “Install.bat” from the SmartTAP 360° Live “Suite\” folder.
2. Select the Distributed Software Custom Setup type.
3. Click AudioCodes Inc. Call Delivery Server.
4. Click **Install** to continue.
5. Select “Microsoft Lync” or “Other” when prompted.
  - Other: (NON Microsoft LYNC)
6. Server IP Setup Screen:
  - Specify the IP of the Communication & Application Servers.
  - Specify the IP of the Local Machine.
7. Click link to install Skype for Business, see Plugin Configuration.
  - Return here once the configuration has completed.
  - No additional CD-IP configuration should be necessary.
8. Click link to install the Other (IP), see [VoIP Port Mirroring on page 135](#).
  - Return here once the configuration has completed.
  - Once the installation of the CD-IP has completed, additional configuration is required, see [Additional Configuration for VoIP Port Mirroring](#) on page 139.
9. Click link to install Analog Trunk/Radio, see [Analog Trunk / Radio](#) on page 142:
  - Return here once the configuration has completed.
  - Once the installation of the CD-AL has completed, additional configuration is required, see [Additional Configuration for Analog Trunk and Radio](#) on page 146.
10. Click **Next** to continue.
11. Click **Install** to complete the installation.

## SmartTAP 360° Live File Server Installation



It is preferable, that the File Server is installed and configured before installation of the (MS) Media Server and the (AS) Application Server.

## Firewall Configuration

It is highly recommended to configure the Firewall with the required ports to ensure proper communication prior to the software installation. See [Firewall Configuration](#) on page 59.

## Domain Controller Configuration

This configuration is an example of what must be performed in a windows environment to allow the SmartTAP software running on a different server to read and write to the file server directory where the recordings are stored. Alternatively, in the absence of a domain controller, the same can be achieved by the configuration of windows file sharing feature.

### ➤ To configure the SmartTAP user on the Windows server Domain Controller:

1. Create a user account for SmartTAP on the Domain Controller. For example “SmartTAP User”:
  - a. In the Active Directory Users and Computers folder, select the Users folder and then right-click **New > User**.

**Figure 5-12: Active Directory Users and Computers**

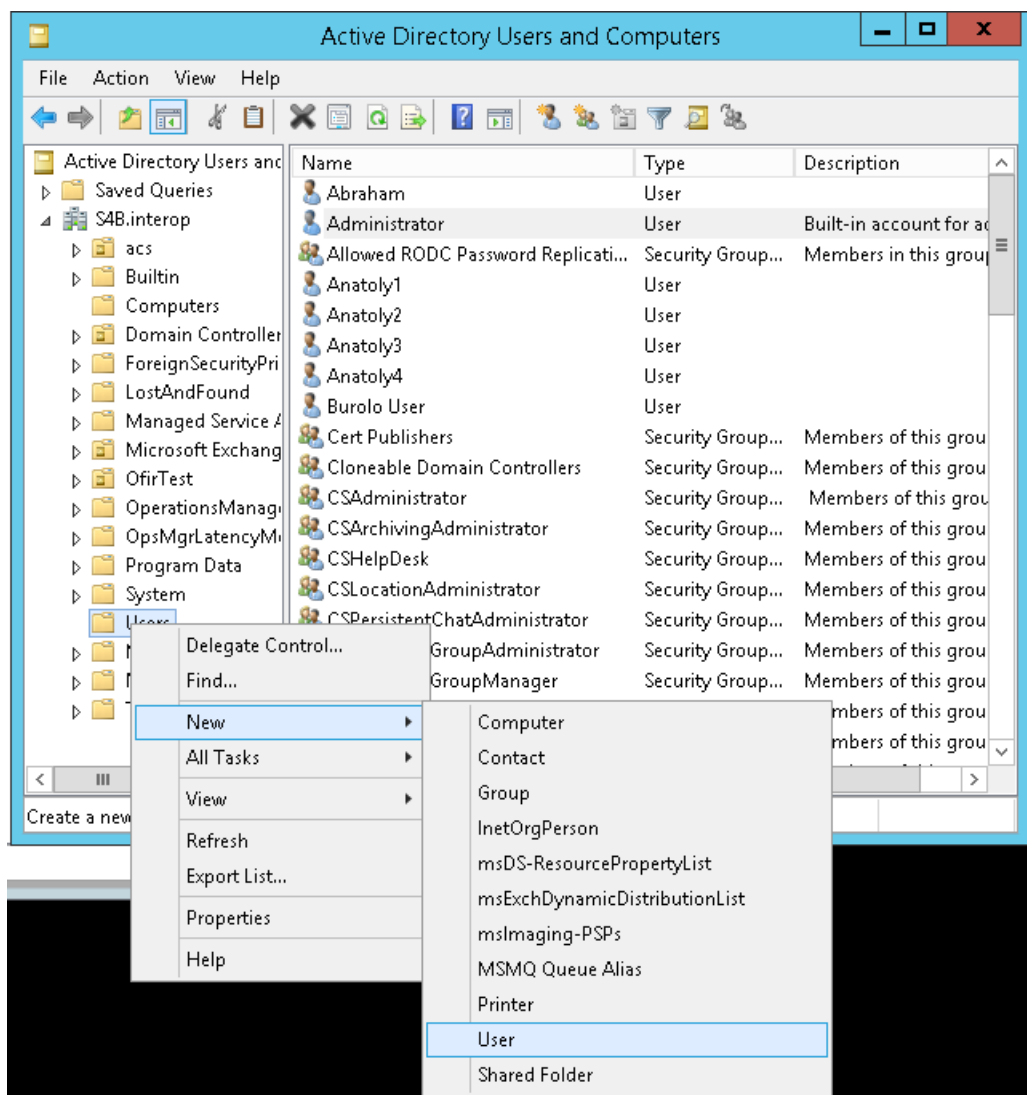
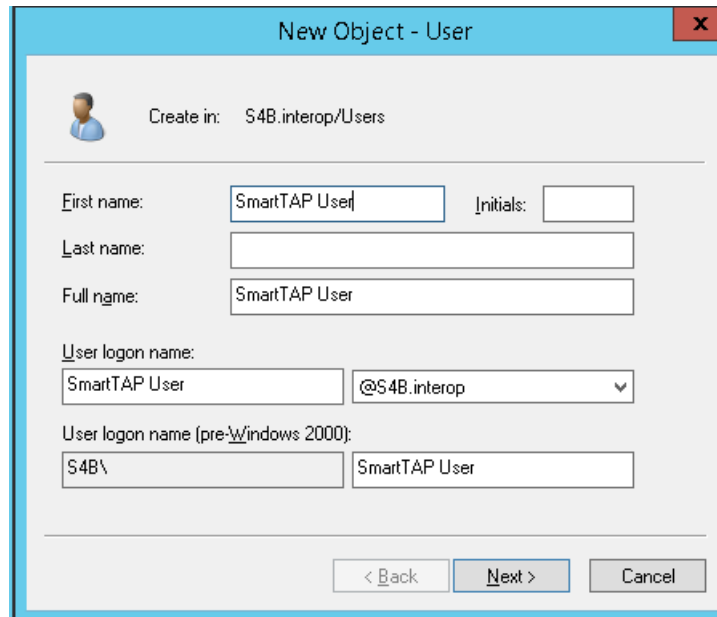


Figure 5-13: New SmartTAP User



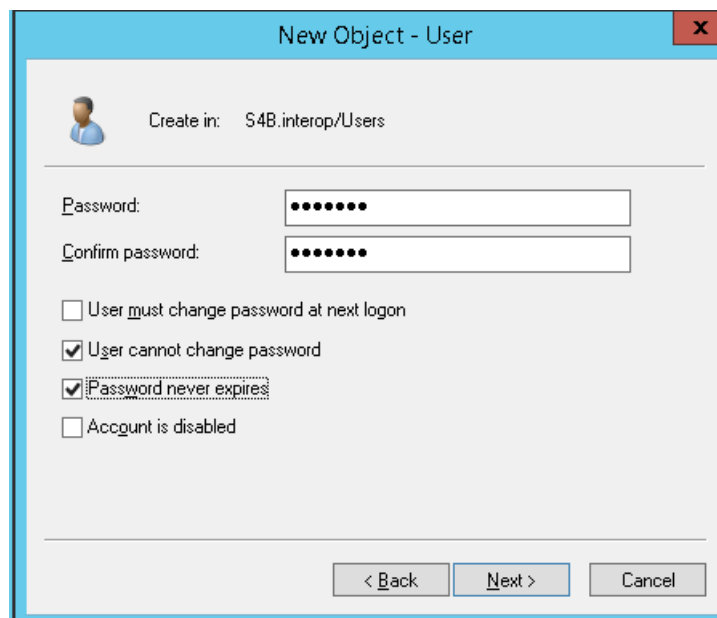
The screenshot shows a dialog box titled "New Object - User" with a close button (X) in the top right corner. Below the title bar, there is a user icon and the text "Create in: S4B.interop/Users". The main area contains several input fields and a dropdown menu:

- First name:** SmartTAP User
- Initials:** (empty field)
- Last name:** (empty field)
- Full name:** SmartTAP User
- User logon name:** SmartTAP User (text field) and @S4B.interop (dropdown menu)
- User logon name (pre-Windows 2000):** S4B\ (text field) and SmartTAP User (text field)

At the bottom, there are three buttons: "< Back", "Next >", and "Cancel".

2. Click **Next**, enter a password and then configure the following settings:
  - a. Clear the **User must change password at next logon** check box.
  - b. Select the **User cannot change password** check box.
  - c. Select the **Password never expires** check box.

Figure 5-14: User Settings



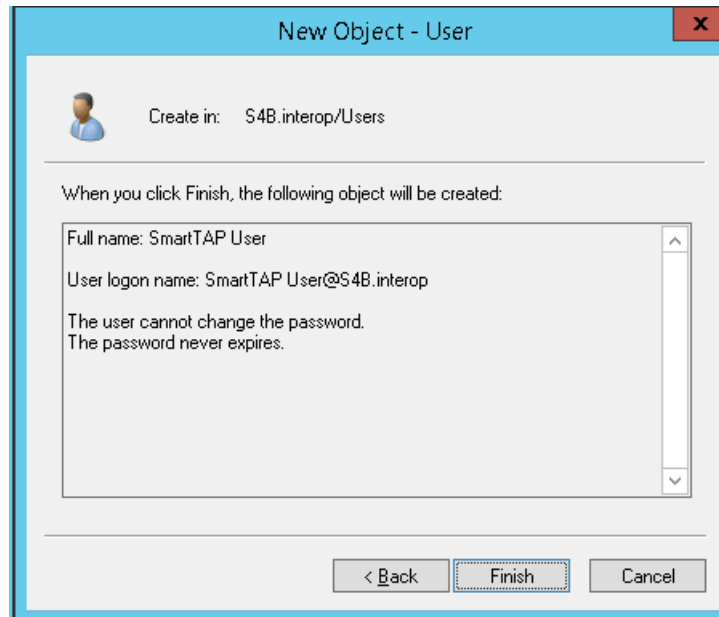
The screenshot shows the same "New Object - User" dialog box, but now it is in the "User Settings" step. The "Password:" and "Confirm password:" fields are filled with dots. Below these fields are four checkboxes:

- User must change password at next logon
- User cannot change password
- Password never expires
- Account is disabled

At the bottom, there are three buttons: "< Back", "Next >", and "Cancel".

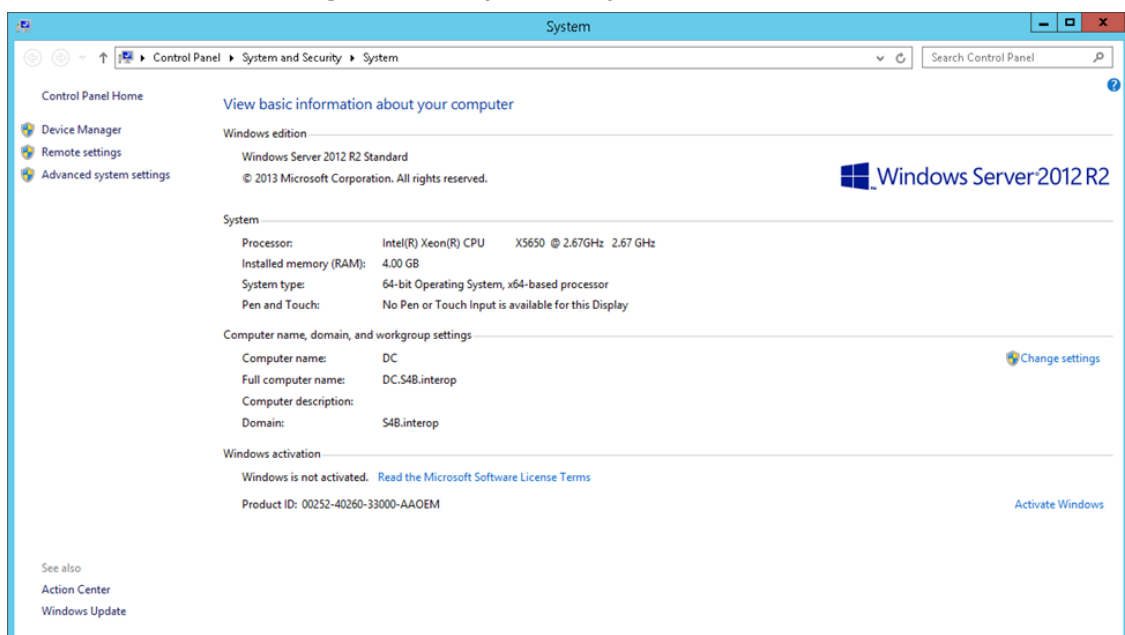
The following confirmation dialog is displayed:

Figure 5-15: User Add Confirmation



3. Click **Finish**.
4. Add the File Server to the Domain:
  - a. Right-click **Start > System**.

Figure 5-16: System Properties



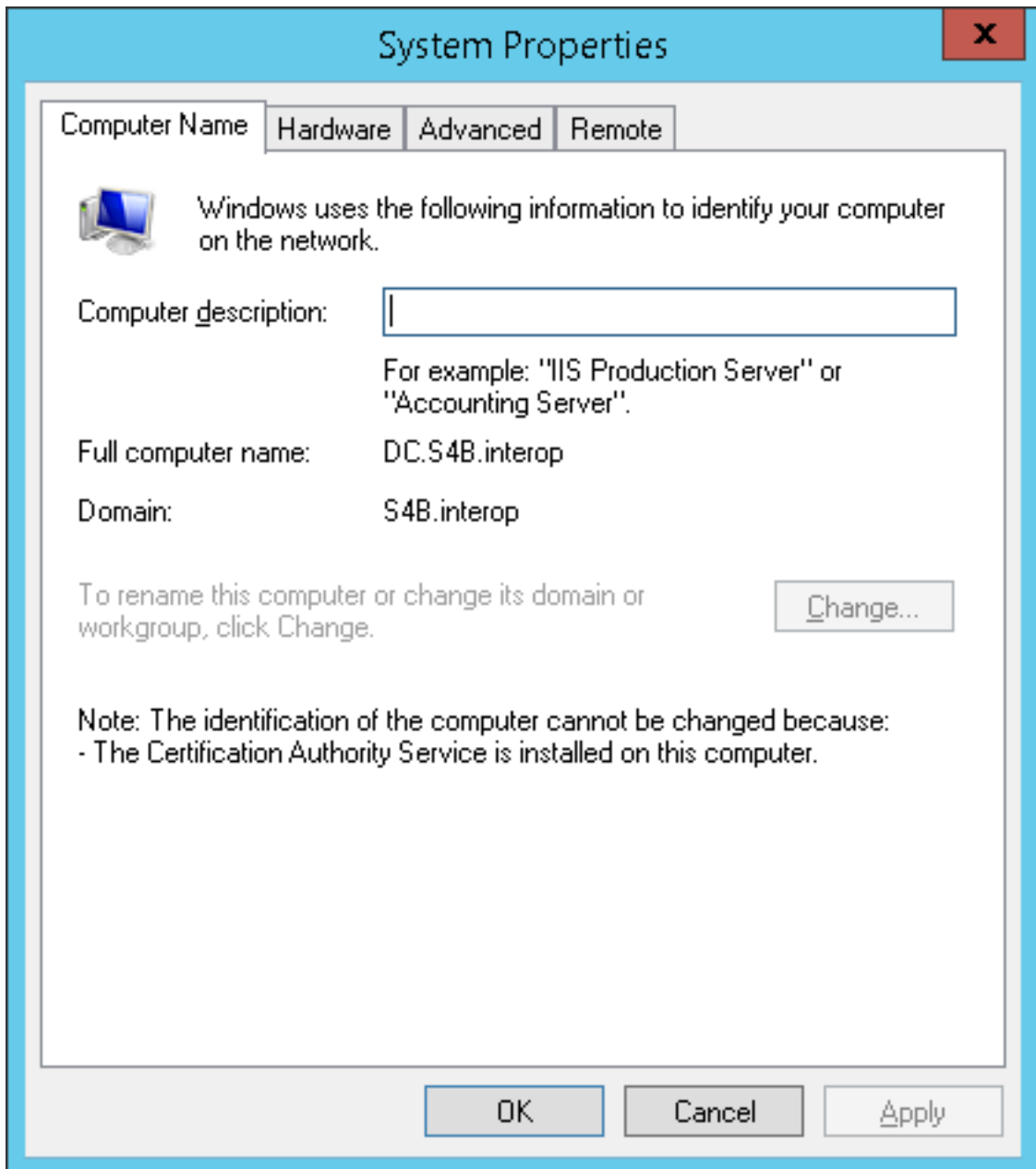
- b. Select **Change settings** in the Computer name, domain, and workgroup settings.
- c. Click **Change.. in the Computer Name** tab.
- d. Select the Domain radio button and enter the name of the domain.
- e. When prompted, enter the domain administrator user and password.



The Welcome to the <domain name> domain dialog confirms that the server is now joined to the domain.

- f. Restart the File Server.

Figure 5-17: System Properties



5. Log in into the file server as user "SmartTAP" in the domain.
6. Create the media storage directory (...\\media) on the file server.
7. Share the media storage:
  - a. Right-click the storage directory and select Properties.
    - ◆ Select the Sharing tab and click share... in the Network File and Folder Sharing section.

- ◆ Click the Share button and enter the domain administrator user and password when prompted.

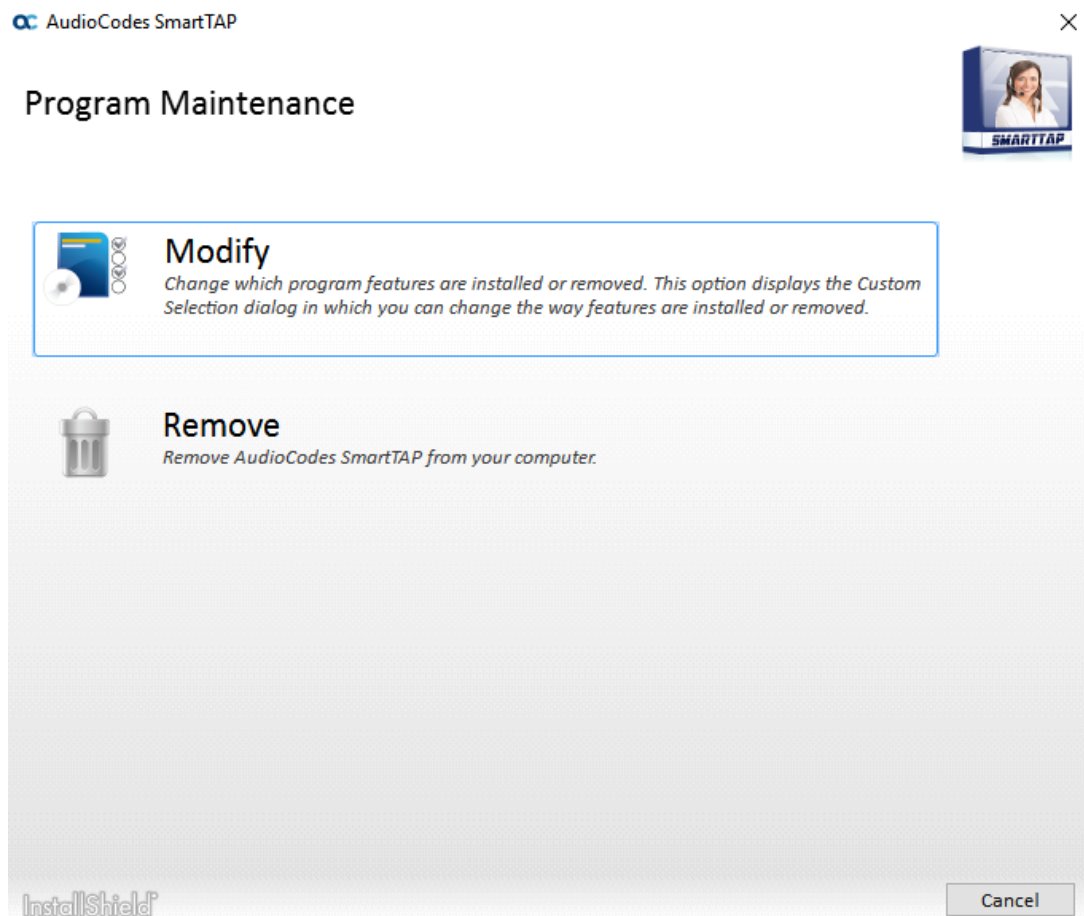
## 6 Uninstalling SmartTAP 360° Live

The following describes how to uninstall SmartTAP 360° Live.

➤ **To uninstall SmartTAP 360° Live:**

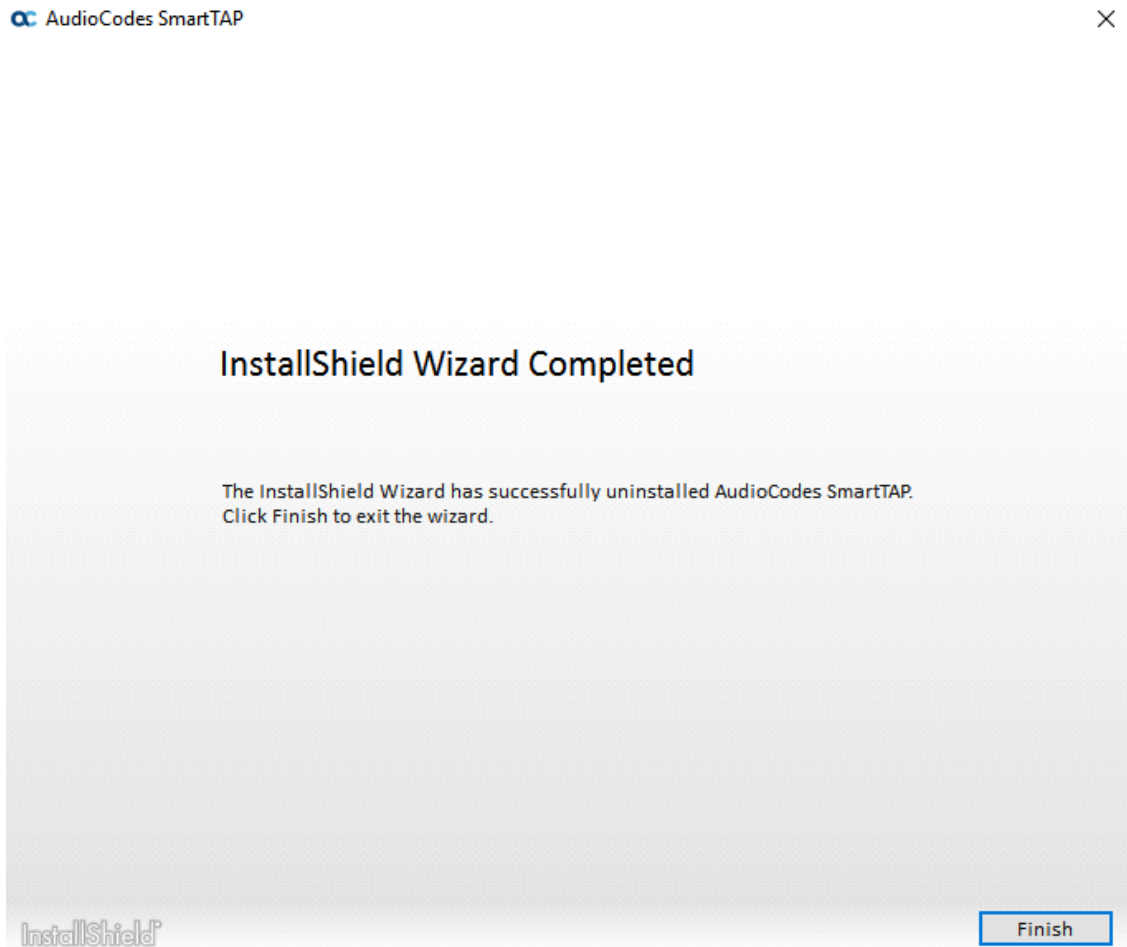
1. Launch install.bat from the “Suite” folder.
2. From the Program Maintenance screen, click Remove to remove the SmartTAP 360° Live component from the PC.

**Figure 6-1: Program Maintenance - Remove**




3. When the InstallShield Wizard Completed screen appears, click Finish.

**Figure 6-2: InstallShield Wizard Completed - Uninstall**



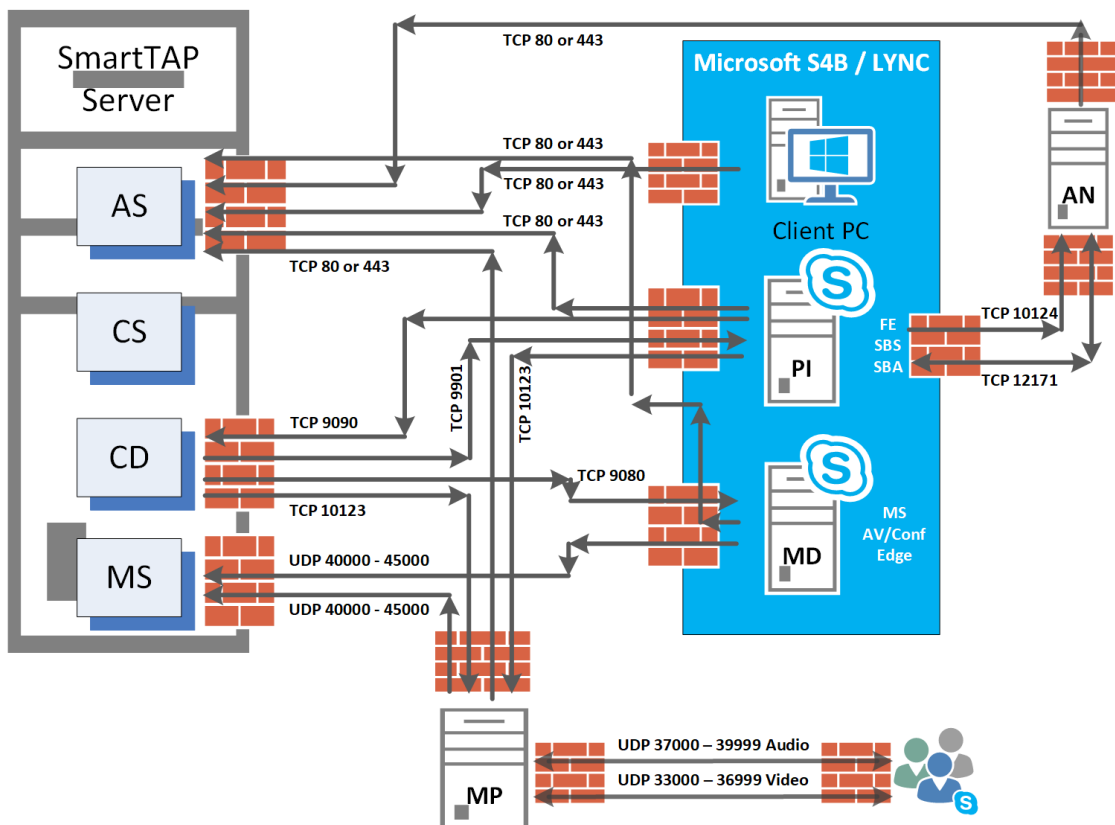
# 7 Firewall Configuration

The deployment of the SmartTAP servers may have to comply with customer security policies, which require the implementation of firewall rules. This section provides the basic information required by the Windows administrator to configure the Windows firewall, to ensure the required connectivity between the SmartTAP applications and services.

 All Firewall ports listed are default ports.

## Skype for Business Recording Firewall

Figure 7-1: Skype for Business Recording Firewall



### Front End Server(s)

The following Inbound firewall exceptions are required.

Table 7-1: Front End Server(s) - Inbound Firewall

Protocol	Allow Port	Allowed Network
TCP	9901	DOMAIN/INTERNAL (from SmartTAP to FE)

Protocol	Allow Port	Allowed Network
TCP	12171	DOMAIN/INTERNAL (from SmartTAP Announcement Server to FE)

The following Outbound firewall rule may be required if the FE has a particularly restrictive firewall configuration (non-Default).

**Table 7-2: Front End Server(s) - Outbound Firewall**

Protocol	Allow Port	Allowed Network
TCP	9090	DOMAIN/INTERNAL (from FE to SmartTAP CD)
TCP	80	DOMAIN/INTERNAL (from FE to SmartTAP AS)
TCP	443	DOMAIN/INTERNAL (from FE to SmartTAP AS when AS is configured with HTTPS)
TCP	10123	DOMAIN/INTERNAL (from FE to SmartTAP MP)
TCP	10124	DOMAIN/INTERNAL (from FE to Announcement server)

## Edge, Mediation or Conference Server(s)

The following Inbound firewall exceptions are required.

**Table 7-3: Edge, Mediation or Conference Server(s) - Inbound Firewall**

Protocol	Allow Port	Allowed Network
TCP	9080	DOMAIN/INTERNAL (from SmartTAP CD)

The following Outbound firewall rules are required if the Edge Server has a particularly restrictive firewall configuration:

**Table 7-4: Edge, Mediation or Conference Server(s) - Outbound Firewall**

Protocol	Allow Port	Allowed Network
UDP	40000-45000	DOMAIN/INTERNAL (towards SmartTAP)
TCP	80	DOMAIN/INTERNAL (from SmartTAP MD to SmartTAP AS)
TCP	443	DOMAIN/INTERNAL (from SmartTAP MD to SmartTAP AS when SmartTAP AS is configured with HTTPS)



To record calls traversing Edge Server (with remote users, federated users) enable A/V/STUN.MSTURN communication with Edge Server Pool on the UDP port 3478 for compliance with MSFT port and planning requirements.

## SmartTAP 360° Live Server

The following Inbound firewall exceptions are required.

**Table 7-5: SmartTAP 360° Live Server - INBOUND Firewall**

Protocol	Allow Port	Allowed Network
TCP	80	<ul style="list-style-type: none"> <li>■ DOMAIN/INTERNAL (from FE servers)</li> <li>■ DOMAIN/INTERNAL (from Edge servers)</li> <li>■ EXTERNAL (Web Browser Access for end-users)</li> </ul>
TCP	443	<ul style="list-style-type: none"> <li>■ DOMAIN/INTERNAL (from FE to AS when AS is configured with HTTPS)</li> <li>■ DOMAIN/INTERNAL (From Edge servers to AS when AS is configured with HTTPS)</li> </ul>
TCP	9090	DOMAIN/INTERNAL (from FE servers)
UDP	40000-45000 <sup>1</sup>	DOMAIN/INTERNAL (from MD) DOMAIN/INTERNAL (from MP servers)
TCP	10125	DOMAIN/INTERNAL (from AS) Note: The port is only required for CD when AS is installed on another server.

The following Outbound firewall exceptions are required.

**Table 7-6: SmartTAP 360° Live Server - Outbound Firewall**

Protocol	Allow Port(s)	Allowed Network
TCP	9080 <sup>1</sup>	DOMAIN/INTERNAL (to MD)
TCP	9901	DOMAIN/INTERNAL (to FE servers)
TCP	10123	DOMAIN/INTERNAL (to MP servers)

<sup>1</sup>Required when Media Delivery resides on Edge, Mediation or Conference server.

## SmartTAP 360° Live Media Proxy Server

The following Inbound firewall exceptions are required.

**Table 7-7: SmartTAP 360° Live Media Proxy Server - Inbound Firewall**

Protocol	Allow Port	Allowed Network
TCP	10123	DOMAIN/INTERNAL (from FE and SmartTAP 360° Live servers)
UDP	37000-39999	DOMAIN/INTERNAL (from Skype for Business clients to MP) (Audio)
UDP	33000-36999	DOMAIN/INTERNAL (from Skype for Business clients to MP) (Video)

The following Outbound firewall exceptions are required.

**Table 7-8: SmartTAP 360° Live Media Proxy Server - Outbound Firewall**

Protocol	Allow Port	Allowed Network
UDP	37000-39999	DOMAIN/INTERNAL (from MP to Skype for Business or Lync clients) (Audio)
UDP	33000-36999	DOMAIN/INTERNAL (from Skype for Business clients to MP) (Video)
UDP	40000-45000	DOMAIN/INTERNAL (from the MP to the MS)
TCP	80	DOMAIN/INTERNAL (from MP to AS)
TCP	443	DOMAIN/INTERNAL (from MP to AS when AS is configured with HTTPS)

## SmartTAP 360° Live Announcement Server

The following Inbound firewall exceptions are required.

**Table 7-9: SmartTAP 360° Live Announcement Server- Inbound Firewall**

Protocol	Allow Port	Allowed Network
TCP	12171	DOMAIN/INTERNAL (from FE servers)
TCP	10124	DOMAIN/INTERNAL (from FE servers)

The following Outbound firewall exceptions are required.



**Table 7-10: SmartTAP 360° Live Announcement Server - Outbound Firewall**

Protocol	Allow Port	Allowed Network
TCP	80	DOMAIN/INTERNAL (from ANN to SmartTAP 360° Live AS)
TCP	443	DOMAIN/INTERNAL (from ANN to SmartTAP 360° Live AS when AS is configured with HTTPS)

For further information regarding Skype for Business port requirements, refer to the following.

<http://technet.microsoft.com/en-us/library/gg398798.aspx>

## Automated Firewall Exception Scripts for Windows Firewall

PowerShell scripts are installed to facilitate in adding firewall exceptions to all of the SmartTAP and Lync components. They are installed by default in the following location:

```
...\AUDIOCODES\SmartTAP\Install\EnableFWRules
```

The following file needs to be modified before it can be used: EnableSmartTAPFWRules.ps1. The configuration section is at the beginning of the Powershell script.

### ➤ To use the script, do the following:

1. Populate all of the fields for your installation. Save the file.
2. Copy the entire directory to each component that needs to have firewall exceptions added (SmartTAP, Skype for Business Edge, Mediation or Conference Server and the Skype for Business Front Ends).
3. On each server, modify the \$machine\_type line to match the machines functionality (SmartTAP, Edge or FE)
4. Run the EnableSmartTAPFWRules.bat to run the script, either by double clicking on it, or running it from a command prompt.
5. You can now confirm that the firewall exceptions have been added. If there was an error that you need to correct, just remove the exceptions that the script added, and rerun the script. All SmartTAP firewall exceptions start with the word "SmartTAP".

## Distributed SmartTAP Firewall

The following firewall rules are required in the event that you install each component of the SmartTAP installation on a physically separate machine (as described in Chapter [Installation Wizard - Distributed Method](#) on page 40). Under normal circumstances, when all of the components are on the same machine you would only need to add an exception for port 80 or 443 (see Section [Application Server \(AS\)](#) on page 65).


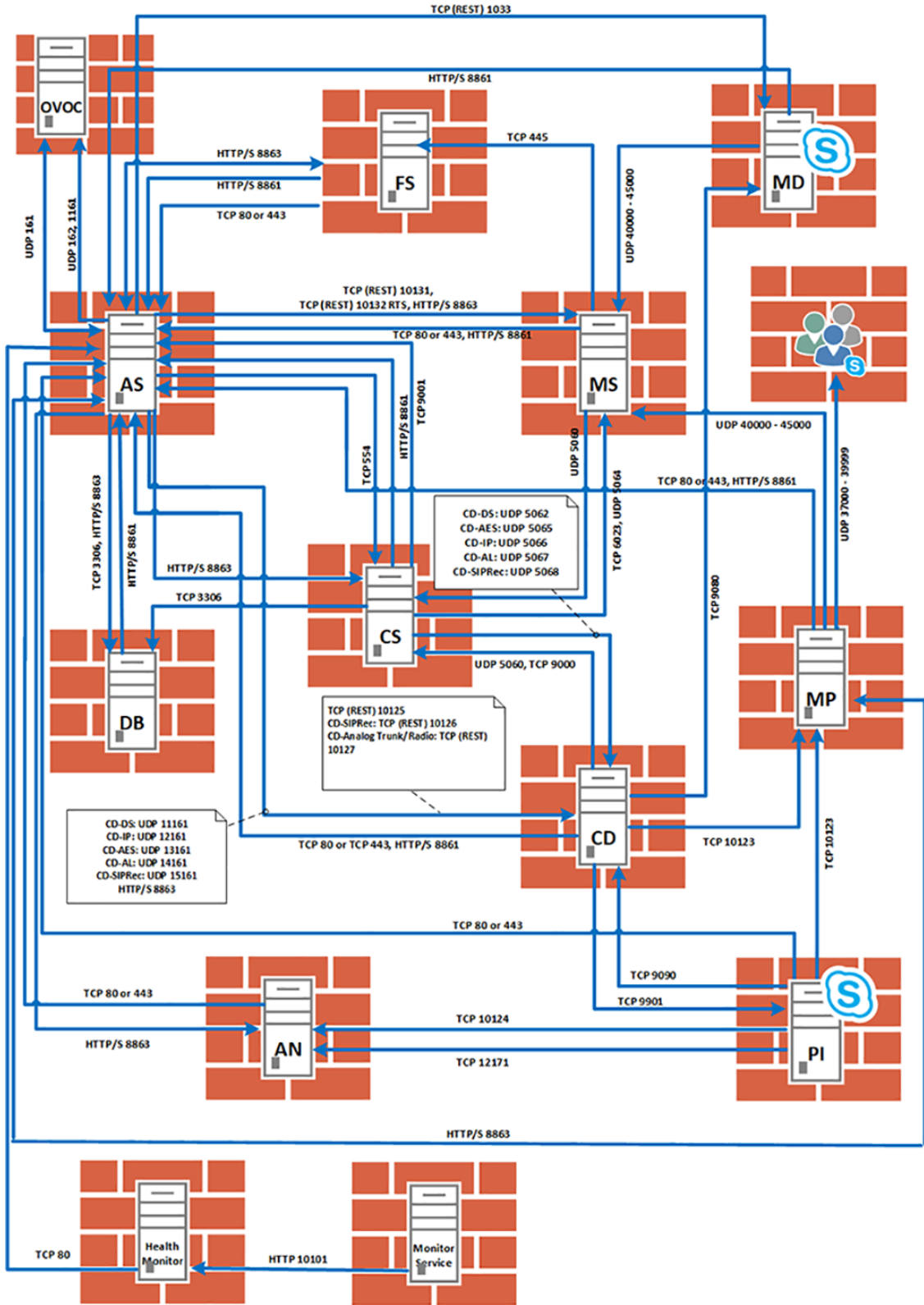
 The Windows firewall must be setup to allow INBOUND connections on the specified ports.

Figure 7-2: Distributed SmartTAP Firewall



## Application Server (AS)

**Table 7-11: Firewall - Application Server (AS)**

Protocol	Allow Port	Allowed Network
TCP	80	EXTERNAL (Web Browser Access for end-users) DOMAIN/INTERNAL (from other SmartTAP servers)
TCP	443	EXTERNAL (Web Browser Access for end-users) DOMAIN/INTERNAL (from other SmartTAP servers)
TCP	9001	DOMAIN/INTERNAL (from other SmartTAP servers)
UDP	161	Used for SNMP traffic for managing traps/alarms between AS and OVOC (Bi-directional)
UDP	162	Used for SNMP traffic for sending Keep-alive messages from AS to OVOC (Send-only)
UDP	1161	Used for SNMP traffic for sending Keep-alive messages from AS to OVOC (this port is predominantly used when AS is installed behind a NAT) (Send-only)
HTTP/S	8861	Communication from OVOC clients (other than SmartTAP servers) to OVOC Main Agent
HTTP/S	8863	Requests sent from OVOC Main Agent to OVOC client agents Virtual Machines (they also run on SmartTAP AS) (send-only).

## Communications Server (CS)

**Table 7-12: Firewall - Communications Server (CS)**

Protocol	Allow Port	Allowed Network
UDP	161, 1161, 5060	DOMAIN/INTERNAL (from other SmartTAP servers)
TCP	554	DOMAIN/INTERNAL (from other SmartTAP servers)
TCP	9000	DOMAIN/INTERNAL (from other SmartTAP servers)

## Database Server (DB)

**Table 7-13: Firewall - Database Server (DB)**

Protocol	Allow Port	Allowed Network
TCP	3306	DOMAIN/INTERNAL (from other SmartTAP servers)
UDP	161	DOMAIN/INTERNAL (from other SmartTAP servers)

## File Server (FS)

**Table 7-14: Firewall - File Server (FS)**

Protocol	Allow Port	Allowed Network
SMB	Windows Network File Sharing (see File Server installation)	DOMAIN/INTERNAL (from Application and Media servers)
UDP	161	DOMAIN/INTERNAL (from other SmartTAP servers)

## Media Server (MS)

**Table 7-15: Firewall - Media Server (MS)**

Protocol	Allow Port	Allowed Network
UDP	5064, 40000-45000	DOMAIN/INTERNAL (from other SmartTAP servers)
TCP	6023	DOMAIN/INTERNAL (from other SmartTAP servers)
TCP REST	10131	DOMAIN/INTERNAL (from other SmartTAP servers)
TCP REST	10132	DOMAIN/INTERNAL (from other SmartTAP servers)

## Remote Transfer Service (RTS)

**Table 7-16: Remote Transfer Service (RTS)**

Protocol	Allow Port	Allowed Network
TCP REST	10132	Remote Transfer Service (RTS)

## Call Delivery(CD)

**Table 7-17: Firewall - Call Delivery(CD)**

Protocol	Allow Port	Allowed Network
UDP (Add any required)	11161 – CD-DS	DOMAIN/INTERNAL (from other SmartTAP servers)
	12161 – All VoIP	DOMAIN/INTERNAL (from other SmartTAP servers)
	13161 – AES	DOMAIN/INTERNAL (from other SmartTAP servers)
	14161 – Analog	DOMAIN/INTERNAL (from other SmartTAP servers)
	15161 – SIPRec	DOMAIN/INTERNAL (from other SmartTAP servers)
	5062-CD-DS	DOMAIN/INTERNAL (from other SmartTAP servers)
	5065-CD-AES	DOMAIN/INTERNAL (from other SmartTAP servers)
	5066 – All VoIP	DOMAIN/INTERNAL (from other SmartTAP servers)
	5067 – Analog	DOMAIN/INTERNAL (from other SmartTAP servers)
	5068 – SIPRec	DOMAIN/INTERNAL (from other SmartTAP servers)
TCP	9090	DOMAIN/INTERNAL (from other SmartTAP servers)
	10125 – All VoIP	DOMAIN/INTERNAL (from other SmartTAP servers)
TCP (REST)	10125	DOMAIN/INTERNAL (from other SmartTAP servers)
TCP (REST)	10126	DOMAIN/INTERNAL (from SIP Recording server)
TCP (REST)	10127	DOMAIN/INTERNAL (from Analog Trunk / Radio)

## Media Delivery (MD)

This applies to Skype for Business Edge, Mediation or Conference servers.

**Table 7-18: Firewall - Media Delivery (MD)**

Protocol	Allow Port	Allowed Network
TCP	9080	DOMAIN/INTERNAL (from other SmartTAP servers)
TCP REST	10133	DOMAIN/INTERNAL (from other SmartTAP servers)
TCP REST	80	DOMAIN/INTERNAL (from other SmartTAP servers)

## Media Proxy (MP)

This applies to SmartTAP Proxy servers exclusively in a Microsoft Skype for Business environment.

**Table 7-19: Firewall - Media Proxy (MP)**

Protocol	Allow Port	Allowed Network
TCP	10123	DOMAIN/INTERNAL (from FE servers)
UDP	37000 - 39999	DOMAIN/INTERNAL (from MP to Skype for Business Skype for Business clients)
UDP	37000 - 39999	DOMAIN/INTERNAL (from Skype for Business clients to MP)

## Announcement Server (AN)

This applies to SmartTAP Announcement servers only in a Microsoft Skype for Business environment.

**Table 7-20: Firewall - Announcement Server (AN)**

Protocol	Allow Port	Allowed Network
TCP	12171	DOMAIN/INTERNAL (from FE servers to SmartTAP Announcement servers).
TCP	10124	DOMAIN/INTERNAL (from FE servers to SmartTAP Announcement servers).

## Example

In this example, we are setting up the Windows server firewall for the Media Server UDP connections. The Media Server firewall must allow inbound connections from the Domain and Internal servers on UDP ports 161, 5064, 10161, and in the range 40000-45000.

### ➤ To setup the firewall for the MS:

1. **Start > Administrative Tools > Windows Firewall with Advanced Security.**
2. Select **Inbound Rules > New Rule.**
3. Select the Port radio button and click **Next.**
4. Select UDP Specific local ports and type in the UDP ports separated by commas and a dash separating the range (161, 5064, 10161, 40000-45000).
5. Select the Allow the connection and click **Next.**
6. Check “Domain” and “Private” and click **Next.**
7. Name the rule and click **Finish** (the rule will be active immediately).

## OVOC Server

The following table describes the ports used for connection with SmartTAP 360° Live server. For more information, refer to the *OVOC IOM Manual*.

**Table 7-21: Firewall -.OVOC Inbound**

Protocol	Allow Port	Allowed Network
UDP	161	Used for SNMP traffic for managing traps/alarms between AS and OVOC (Bi-directional)
UDP	1161	Used for SNMP traffic for sending Keep-alive messages from AS to OVOC (this port is predominantly used when AS is installed behind a NAT) (Send-only)
UDP	162	Used for SNMP traffic for sending Keep-alive messages from AS to OVOC (Send-only)

## 8 Microsoft Skype for Business Deployment

In a Skype for Business environment, SmartTAP will deploy a trusted plugin application on the standard or enterprise Front End Server (Pool). The configured plugin sends the necessary signaling from the FE, SBS or SBA to the SmartTAP server(s) so that SmartTAP is aware of call states only for recorded calls. Using the call signaling, SmartTAP can then correlate the SRTP data to record the complete call. The SRTP data is captured in various ways depending upon what call types need to be recorded. See table below for details.

**Figure 8-1: Capture Call Signaling - 1**

Criteria	Capture Call Signaling			Capture Call Audio			
	Front End Server	SBA Appliance	Proxy Server	Edge Server	Mediation Server	Conference Server	Mirror Port
Requires SmartTAP software	YES	YES	YES	YES	YES	YES	n/a
Data Captured	SIP	SIP	SRTP	SRTP	SRTP	SRTP	SRTP
Mirror Port Required	n/a	n/a	n/a	n/a	n/a	n/a	YES
Media Path Routing	n/a	n/a	YES	YES	n/a	n/a	n/a
Client to Client	✓	✓	✓	✓	n/a	n/a	✓
PSTN – Media Bypass Disabled	✓	✓	✓	✓	✓	n/a	✓
PSTN - Media Bypass Enabled	✓	✓	✓	✓	n/a	n/a	✓
Conferencing	✓	n/a	✓	✓	n/a	✓	✓
Remote / Federated	✓	n/a	n/a	✓	n/a	n/a	n/a
Mobile	✓	n/a	n/a	✓	n/a	n/a	n/a
Home User	✓	n/a	n/a	✓	n/a	n/a	n/a

✓ = Call Type Supported | n/a = Not Applicable

The following table lists the SmartTAP software components and the appropriate deployment server.

**Figure 8-2: Capture Call Signaling - 2**

Software	Capture Call Signaling			Capture Call Audio					
	SmartTAP Server	Front End Server	SBA Appliance	Proxy Server	Edge Server	Mediation Server	Conference Server	Mirror Port	S4B Client
S4B / Lync plug-in	n/a	✓	✓	n/a	n/a	n/a	n/a	n/a	n/a
Application Server	✓	n/a	n/a	n/a	n/a	n/a	n/a	n/a	n/a
Communication Server	✓	n/a	n/a	n/a	n/a	n/a	n/a	n/a	n/a
Database	✓	n/a	n/a	n/a	n/a	n/a	n/a	n/a	n/a
Media Server	✓	n/a	n/a	n/a	n/a	n/a	n/a	n/a	n/a
Call Delivery	✓	n/a	n/a	n/a	n/a	n/a	n/a	n/a	n/a
Media Delivery	n/a	✓ <sub>1</sub>	✓ <sub>1</sub>	n/a	✓	✓	✓	n/a	n/a
Media Proxy	n/a	n/a	n/a	✓ <sub>2</sub>	n/a	n/a	n/a	n/a	n/a
SmartTAP CWE Toolbar	n/a	n/a	n/a	n/a	n/a	n/a	n/a	n/a	✓ <sub>3</sub>

- <sup>1</sup> Assumes Mediation or Conference server are co-located.
- <sup>2</sup> Proxy Server must be installed on dedicated physical or virtual server.
- <sup>3</sup> Requires configuration of Microsoft Skype for Business client. No software is installed.



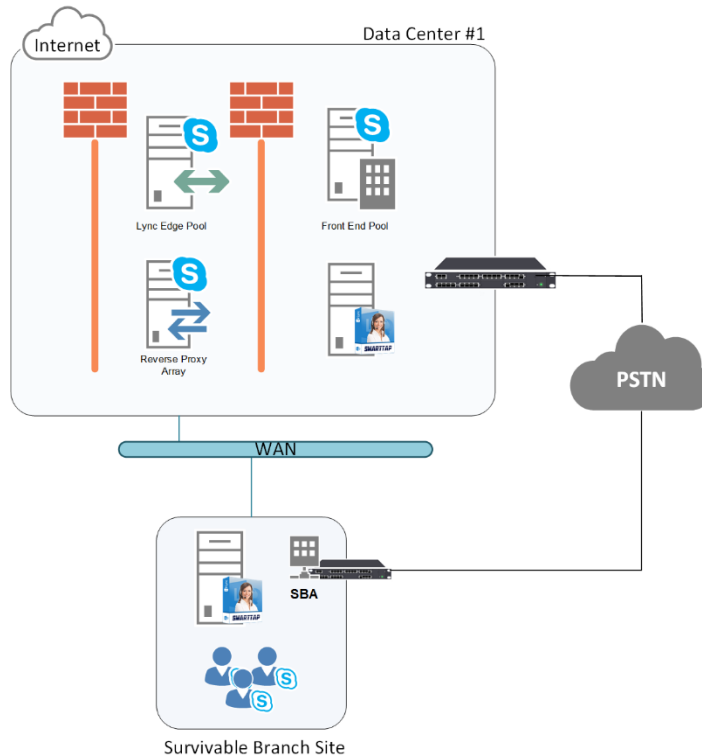
Unlike other IP Station side IP PBX, Skype for Business recording requires the installation of the AudioCodes Microsoft trusted plugin on the Front End (FE) servers, and the Skype for Business specific configuration on the Call Delivery.

This chapter describes the following procedures for installing and configuring SmartTAP to Record Skype for Business:

- Installing SmartTAP 360° Live Skype for Business plugin (see [Installing Skype for Business Plugin](#) on page 75 [Installing Skype for Business Plugin](#) on page 75)
- Installing SmartTAP Call Delivery, choose Microsoft Lync as network type (see [Installing Call Delivery for Skype for Business \(IP-based Recording\)](#) on page 95)
- Installing Media Proxy in case of utilizing the Media Proxy solution (see [Installing Media Proxy Server for Skype for Business](#) on page 108)
- Installing SmartTAP Media Delivery (see [Installing Media Delivery Server for Skype for Business](#) on page 116)
- Installing Announcement Server (see [Installing Announcement Server](#) on page 117)
- Installing SmartTAP Monitoring Service (see [Installing SmartTAP Monitoring Service](#) on page 129)

## Skype for Business Remote Branch Site

The Remote site is typically a branch location that connects back to the main data center. The branch site may or may not have survivable telephony services if the WAN goes down. SmartTAP 360° Live deployed in the branch location can record user/device calls regardless of WAN up/down.

**Figure 8-3: Skype for Business Remote Branch Site**

In the main datacenter, you may deploy an All-In-One solution or distributed. In the branch, you will typically use the Distributed configuration setup because not all components are required in the branch site.

In the branch, the following components are required:

Microsoft SBA:

- Install Skype for Business plugin on SBA (Separate installer not part of the distributed setup package). See Section [Microsoft Skype for Business Deployment](#) on page 70.
- (Optional) Install Media Delivery to record PSTN calls. See Section [Installing Media Proxy Server for Skype for Business](#) on page 108.

SmartTAP 360° Live Server:

- Install Communication Server. See Section [Installing SmartTAP Communication Server](#) on page 43.
- Install Media Server. See Section [Installing SmartTAP Media Server](#) on page 44.
- Install Call Delivery Server. See Section [Installing SmartTAP Call Delivery Server](#) on page 51.

Media Proxy: (Optional):

- Install Media Proxy (Optional method to record Internal IP-to-IP and PSTN calls). See Section [Installing Media Proxy Server for Skype for Business](#) on page 108.

## Before Installing Microsoft Skype for Business Components

This section lists the Microsoft requirements for the SmartTAP 360° Live components for different Skype for Business deployments.

### ■ Unified Communications Managed API (UCMA):

- For Announcement server, SmartTAP Monitoring Service, Microsoft Lync Server 2013 Plugin, Skype for Business 2015 Plugin and Skype for Business 2019 Plugin, this component must be pre-installed with the following versions:
  - ◆ Skype for Business 2019:  
UCMA 6.0
  - ◆ Skype for Business 2015: UCMA 5.0
  - ◆ Lync Server 2013: UCMA 4.0
- For Media Proxy server, installation is not required
- **UCMA6 Windows Server Updates:**
  - ◆ Windows Server 2016 with the latest update
  - ◆ Windows Server 2019 with the latest update
- **UCMA6 Runtime requirements:**
  - ◆ The target platform must be a 64-bit computer
  - ◆ Microsoft .NET framework 4.7 or later service packs
  - ◆ For details on the latest UCMA6 updates, see: <https://www.microsoft.com/en-us/download/details.aspx?id=57507>

### ■ Windows Server 2016:

- The Announcement Server, SmartTAP Monitoring Service and the Skype for Business 2019 Plugin must run on Windows Server 2016 when running on the Skype for Business 2019 platform.

■ **Anti-virus software** If the Windows server run anti-virus software, then SmartTAP components should be included in the anti-virus software's exception list.

■ **HTTPS:** several of the installation setups includes an option to enable an HTTPS connection between the SmartTAP Application server and the Announcement server. These settings, do not entirely complete the HTTPS setup, therefore you must also run the procedures described in [Configuring HTTP/S](#) on page 165.

■ For Announcement server-specific requirements, see [Announcement Server-Specific Requirements](#) on the next page

■ For SmartTAP Monitoring Service-specific, see [SmartTAP 360° Live Monitoring Service-Specific Requirements](#) on the next page

■ For details on configuring a remote branch site in a Skype for Business deployment, see [Skype for Business Remote Branch Site](#) on page 71

## Announcement Server-Specific Requirements

- Ensure the Announcement installation server platform is joined to the domain
- Stand-alone Physical or Virtual server
- Microsoft Windows Server 2012/R2 and Microsoft Windows Server 2016
- Microsoft Windows Server 2012 and Microsoft Windows Server 2016 features:
  - Windows Server Media Foundation
  - Windows Identify Foundation
- Windows Server 2016 is required when recording on the Skype for Business 2019 platform.
- From the Skype for Business Installation Media:
  - Skype for Business Local Config Store - (Skype for Business Install CD) - Core components
  - Skype for Business Administration Tools (Skype for Business Install CD)

## Firewall Configuration

It is highly recommended to configure the Firewall with the required ports to ensure proper communication prior to the software installation. See Chapter [Firewall Configuration](#) on page 59.

## SmartTAP 360° Live Monitoring Service-Specific Requirements

The SmartTAP 360° Live Monitoring Service-Specific requirements are described below:

- Should be installed on a server that is joined to the domain
- Media Foundation
- Health Monitor installed locally or on a remote machine.
  - For the Skype for Business 2015 and 2019 deployment:
    - ◆ Skype for Business Local Config Store - (Skype for Business Install CD) - Core components
    - ◆ Skype for Business Administration Tools (Skype for Business Install CD)
  - For the Lync 2013 deployment:
    - ◆ Lync 2013 Local Config Store - (Lync 2013 Install CD) - Core components
    - ◆ Skype for Business Administration Tools (Lync 2013 Install CD)
    - ◆ Make sure UCMA 4.0 is installed.

## Installing Skype for Business Plugin

The Skype for Business plugin is a Microsoft trusted application that communicates with the Front End Software and provides the SmartTAP server with the signaling and metadata of calls to record. The Skype for Business plugin must be installed on every Front End Server, SBA or SBS that may process calls to record.

The following pre installation actions must be performed:

- [Skype for Business Plugin-Pre-install Setup on AD Domain Controller](#) below
- [Skype for Business Plugin Pre-install Setup on each Front End, SBS or SBA](#) on page 79

The installation procedure is described in [Skype for Business Plugin Installation Procedure](#) on page 88



- It is highly recommended to configure the Firewall with the required ports to ensure proper communication prior to the software installation. See [Firewall Configuration](#) on page 59.
- Install the Skype for Business plugin described in this section on every Front End Server processing calls to record.
- Before proceeding, ensure that you have noted the installation requirements (see [Before Installing Microsoft Skype for Business Components](#) on page 73).

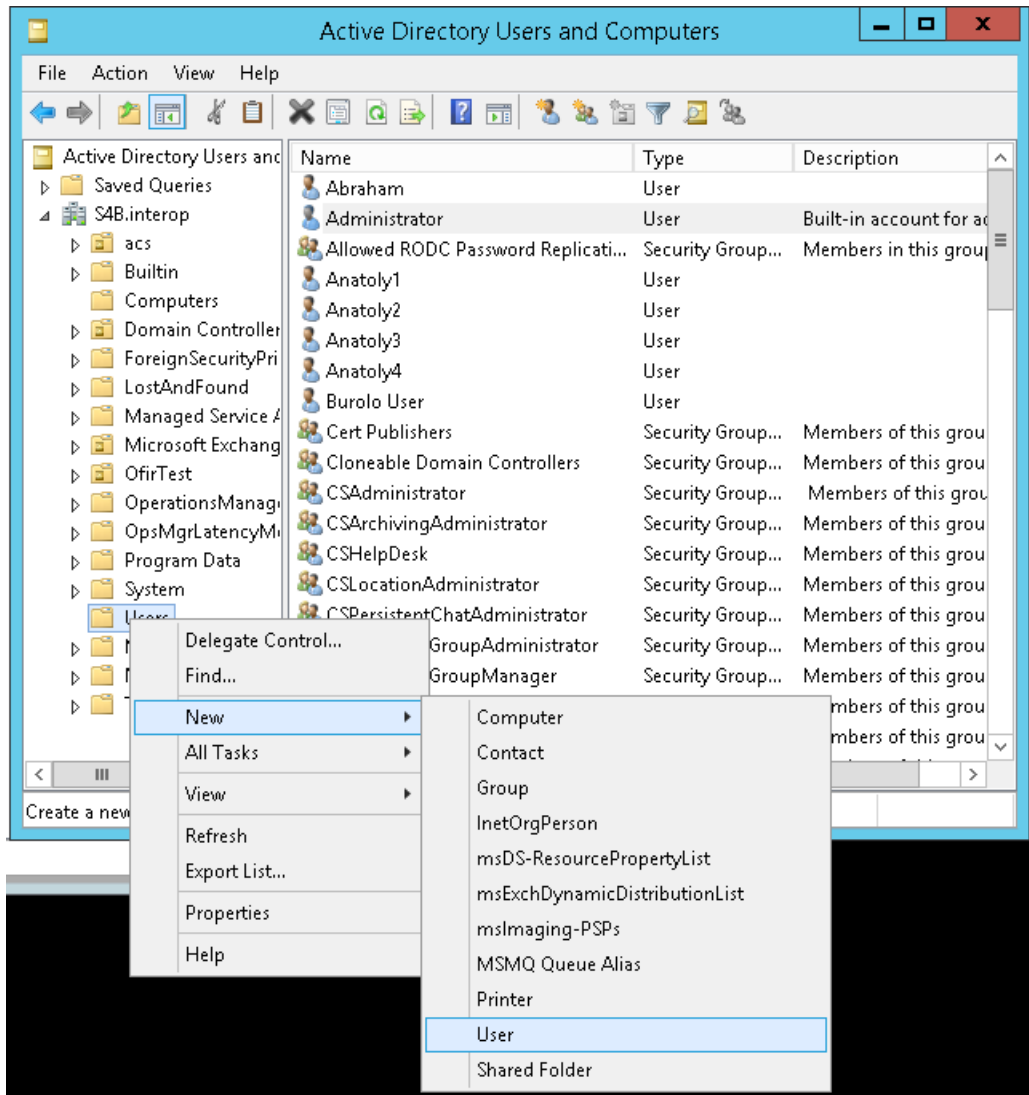
### Skype for Business Plugin-Pre-install Setup on AD Domain Controller

This section describes the pre-install setup for the Skype for Business Plugin on the Active Directory Domain Controller.

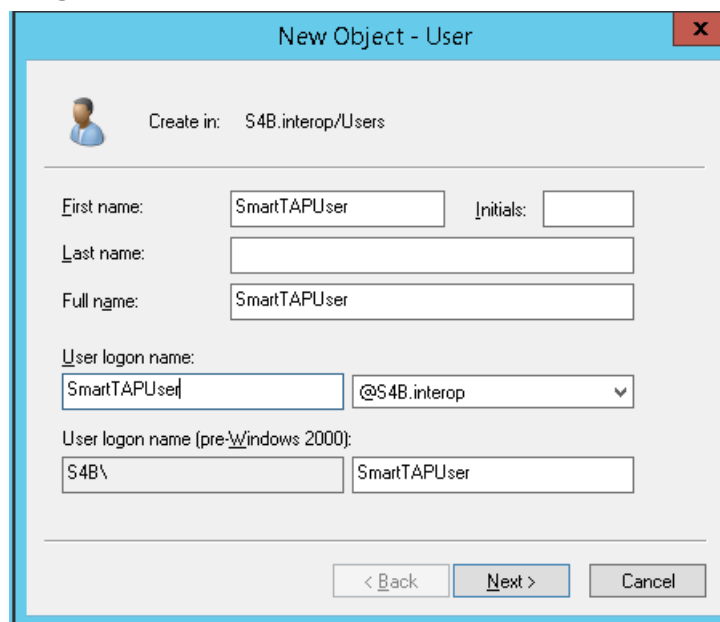
➤ **Do the following:**

1. Create a user account for SmartTAP 360° Live on the domain. For example “SmartTAPUser”:
  - a. In the Active Directory Users and Computers folder, select the Users folder and then right-click **New > User**.

**Figure 8-4: Active Directory Users and Computers**



**Figure 8-5: New SmartTAP 360° Live User**



- b. Enter the name of the SmartTAP 360° Live user in the First Name and User logon name fields and click **Next**.

**Figure 8-6: Password Never Expires**

The screenshot shows a dialog box titled "New Object - User" with a close button (X) in the top right corner. Below the title bar, there is a user icon and the text "Create in: S4B.interop/Users". The main area contains two text input fields for "Password:" and "Confirm password:". Below these fields are four checkboxes: "User must change password at next logon", "User cannot change password", "Password never expires" (which is checked), and "Account is disabled". At the bottom of the dialog are three buttons: "< Back", "Next >", and "Cancel".

- c. Enter a password, confirm the new password, select the "Password never expires" check box and click **Next**.

The following confirmation dialog is displayed:

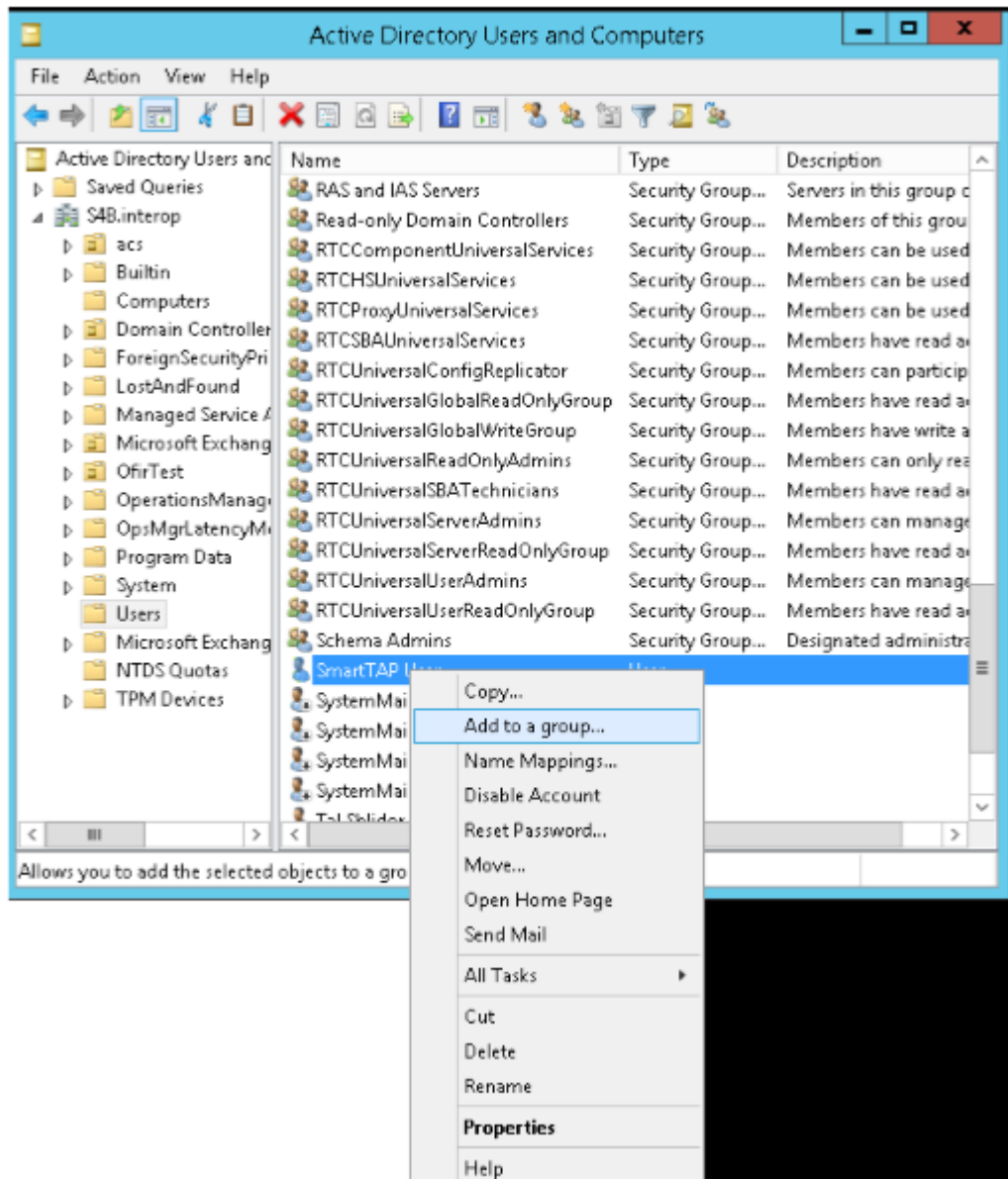
**Figure 8-7: User Add Confirmation**

The screenshot shows the same "New Object - User" dialog box, but now it displays a confirmation summary. The text "When you click Finish, the following object will be created:" is followed by a scrollable text area containing: "Full name: SmartTAPUser", "User logon name: SmartTAPUser@S4B.interop", and "The password never expires." At the bottom of the dialog are three buttons: "< Back", "Finish", and "Cancel".

- d. Click **Finish**.
2. (Optional) Add the account to the "CSAdministrator" group. This membership is not mandatory; however, may be required for running the Plugin installation. The account can be removed from the group after the installation:

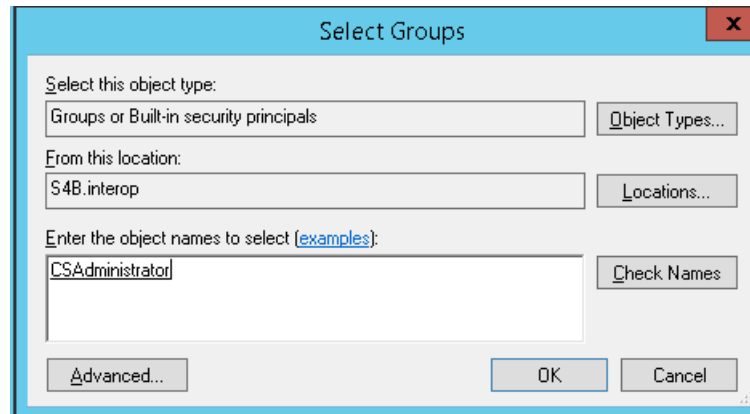
- a. Right-click the newly created SmartTAP 360° Live user and choose **Add to a group**.

**Figure 8-8: Add SmartTAP 360° Live user to CSAdministrators group**

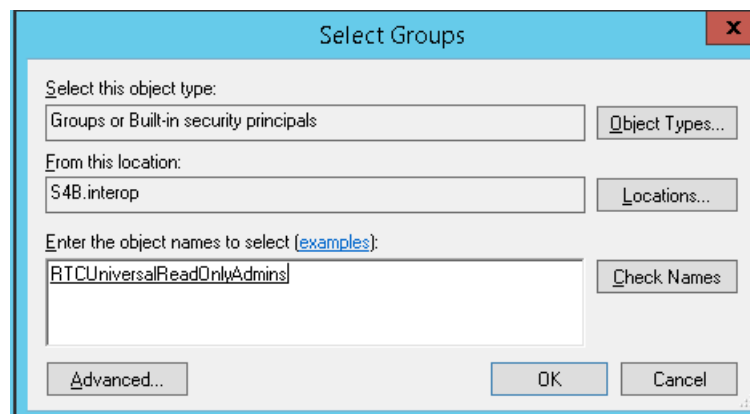


- b. Enter CSAdministrator and then click Check Names. The successfully recognized entry is underlined.



**Figure 8-9: Add Smart TAP User to CSAdministrator**

- c. Click **OK**. A confirmation screen is displayed.
3. Add the SmartTAP 360° Live account to the RTCUniversalReadOnlyAdmins group. This account must be part of "RTCUniversalReadOnlyAdmins" group. This group membership enables the Plug-in to retrieve the Skype For Business topology:
    - a. Right-click the newly created SmartTAP 360° Live user and choose Add to a group.
    - b. Enter RTCUniversalReadOnlyAdmins and then click **Check Names**. The successfully recognized entry is underlined.

**Figure 8-10: Add Smart TAP User to RTCUniversalReadOnlyAdmins**

- c. Click **OK**. A confirmation screen is displayed.

## Skype for Business Plugin Pre-install Setup on each Front End, SBS or SBA

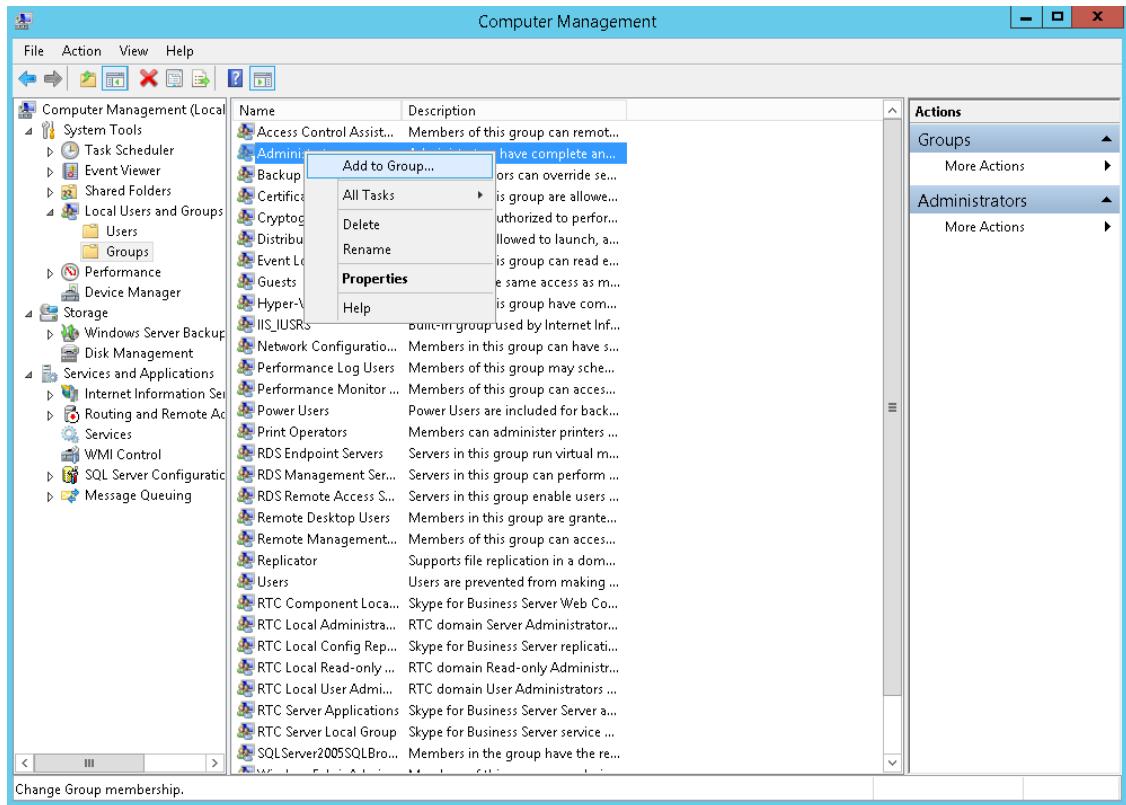
This section describes the setup on the Front End, SBS or SBA.

### ➤ Do the following:

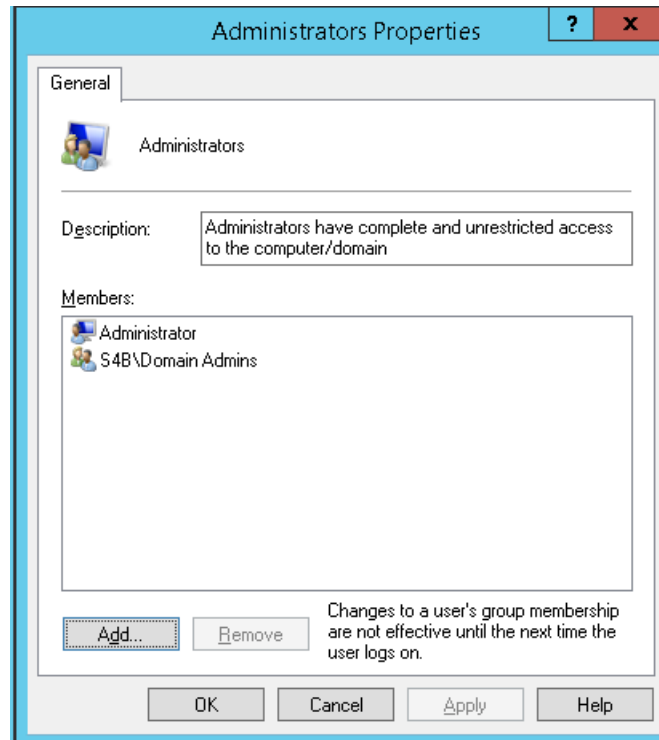
1. Add new "SmartTAP 360° Live User" to the local "Administrators" group:
  - a. Log in to the machine using a local administrator or a domain administrator account.
  - b. Open the Computer Management window.

- c. Open the Local Users and Groups folder.
- d. Select the Groups folder and then select the Administrators entity.
- e. Right-click and choose **Add to Group**.

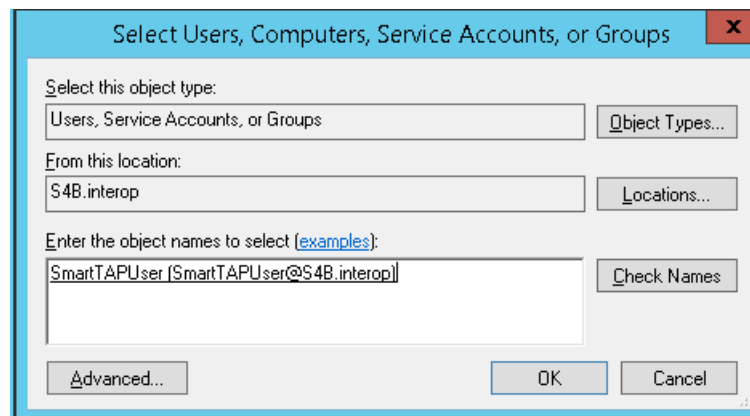
**Figure 8-11: Add SmartTAP 360° Live user to the Administrators group**



- f. In the Administrator Properties window, click **Add**.

**Figure 8-12: Administrators Properties**

- g. Enter the name of the SmartTAP 360° Live user (that you created on the Domain Controller) and then click Check Names. The successfully added entry is highlighted.

**Figure 8-13: SmartTAP 360° Live User Added to Administrators**

- h. Click OK. A confirmation screen is displayed.
2. Add the SmartTAP 360° Live user to the RTCServerApplications group. The group membership enables the Plug-in to register and operate as a Skype For Business Trusted application:
- a. Select the RTCServerApplications entity, right-click and choose **Add to Group**.

Figure 8-14: RTCServerApplications

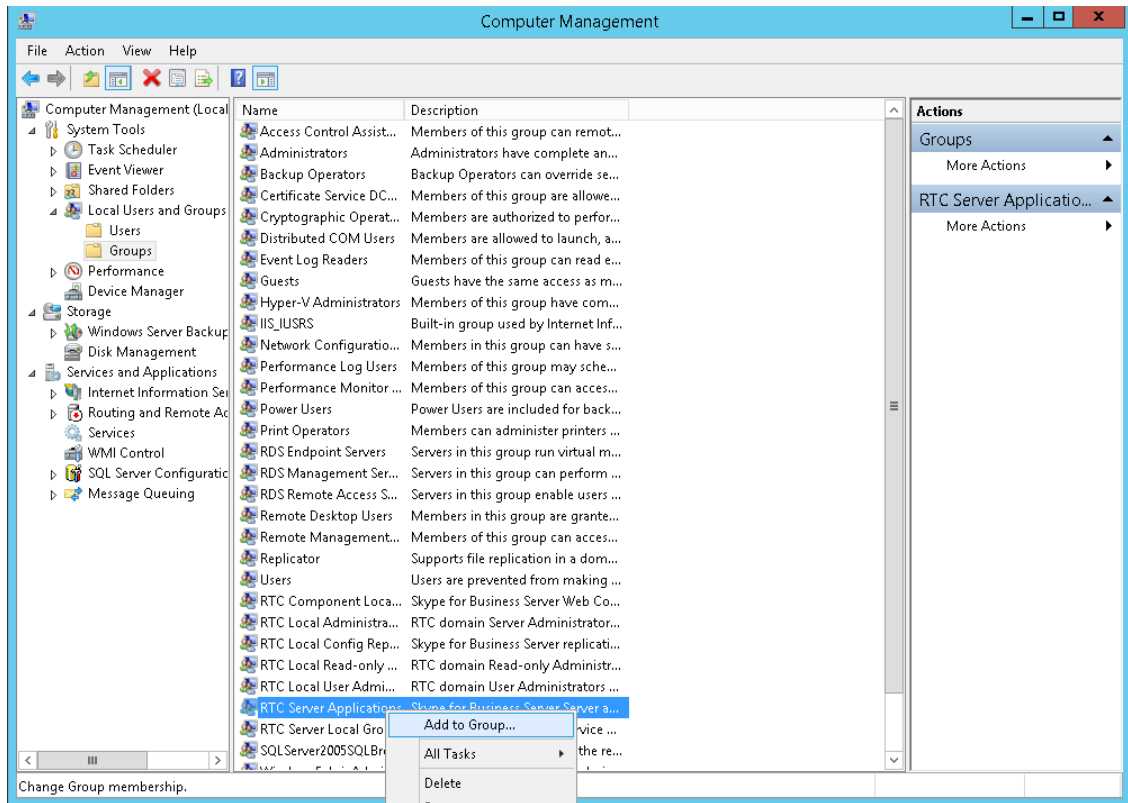
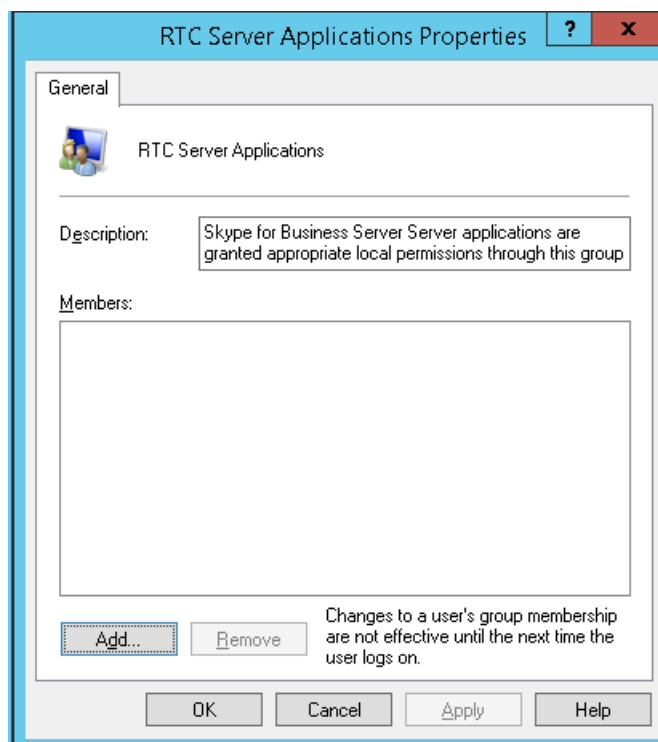


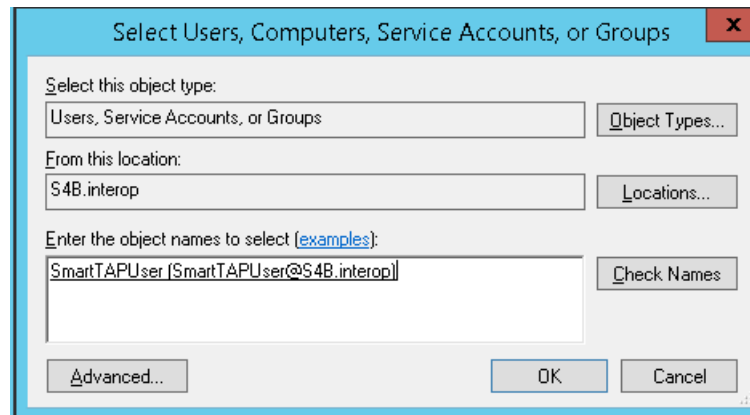
Figure 8-15: RTC Server Applications Properties



b. In the RTC Server Applications Properties screen, click **Add**.

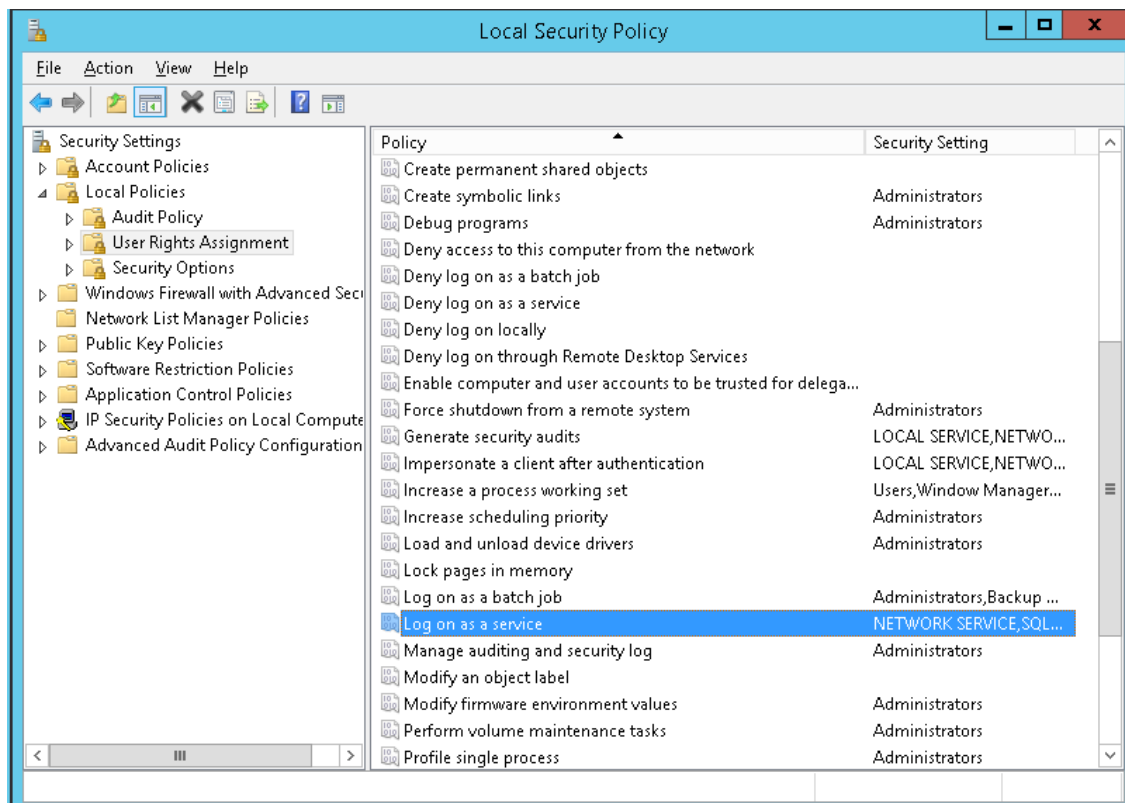
- c. Enter the name of the SmartTAP 360° Live user (that you created above on the Domain Controller) and then click Check Names. The successfully added entry is highlighted.

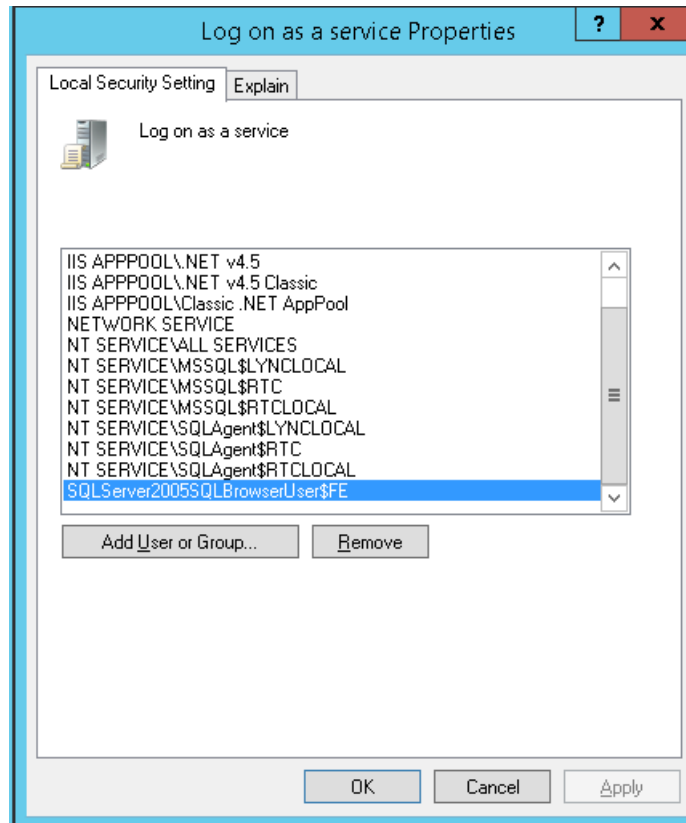
**Figure 8-16: Add RTC Server Applications User**



- d. Click **OK**. A confirmation screen is displayed.
3. **Assign “logon as service” privileges to the “SmartTAPUser” account:**
    - a. Open **Administrative Tools > Local Policies > User Rights Assignment**.
    - b. Select the Log on as a service entity.
    - c. Enable the Computer Browser service.

**Figure 8-17: Local Security Policy**



**Figure 8-18: Log on as a service Properties**

4. Assign the SmartTAP 360° Live user account with at least RemoteSigned execution policy. RemoteSigned execution policy is required for executing PowerShell scripts during the Plugin's installation and run time.

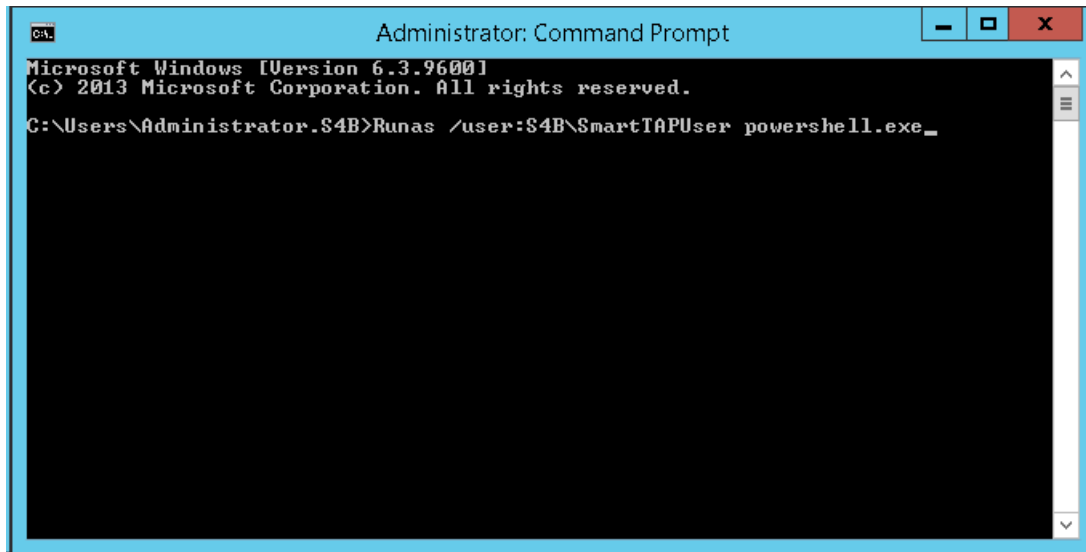
- a. Run PowerShell as the "SmartTapUser" that you defined on the Domain Controller using one of the following methods:

- ◆ Command line:

Enter the following command and press enter:

```
Runas /user:[domain]\SmartTapUser powershell.exe
```

Figure 8-19: SmartTAP 360° Live User



Enter the SmartTAP 360° Live User password that you defined for the user defined on the Domain Controller and press enter.

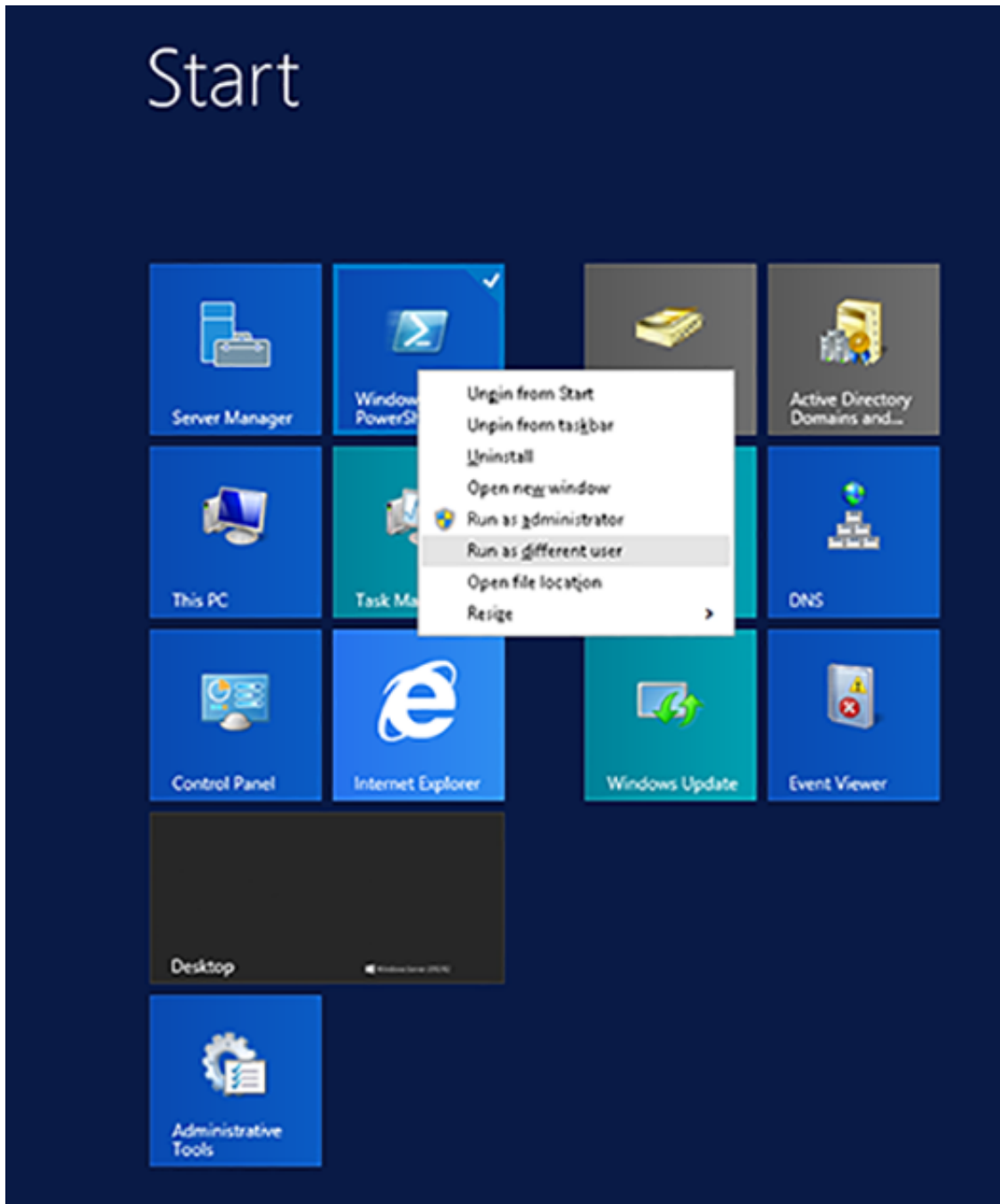


If the SmartTAP 360° Live username contains spaces, ensure that you insert quotation marks at the beginning and end of the user name string in the command line e.g. "SmartTAP 360° Live User".

◆ Using PowerShell:

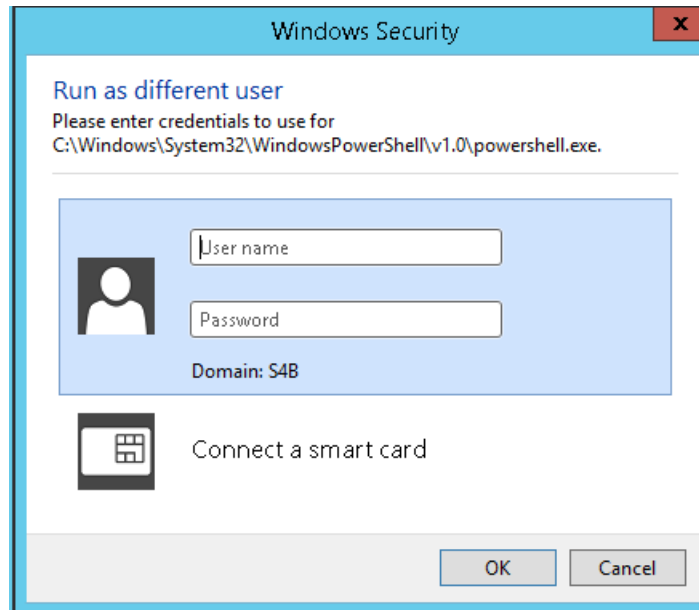
-On the Domain Controller in the Start menu, right-click the Windows PowerShell icon and choose Run as different user:

Figure 8-20: Start Menu



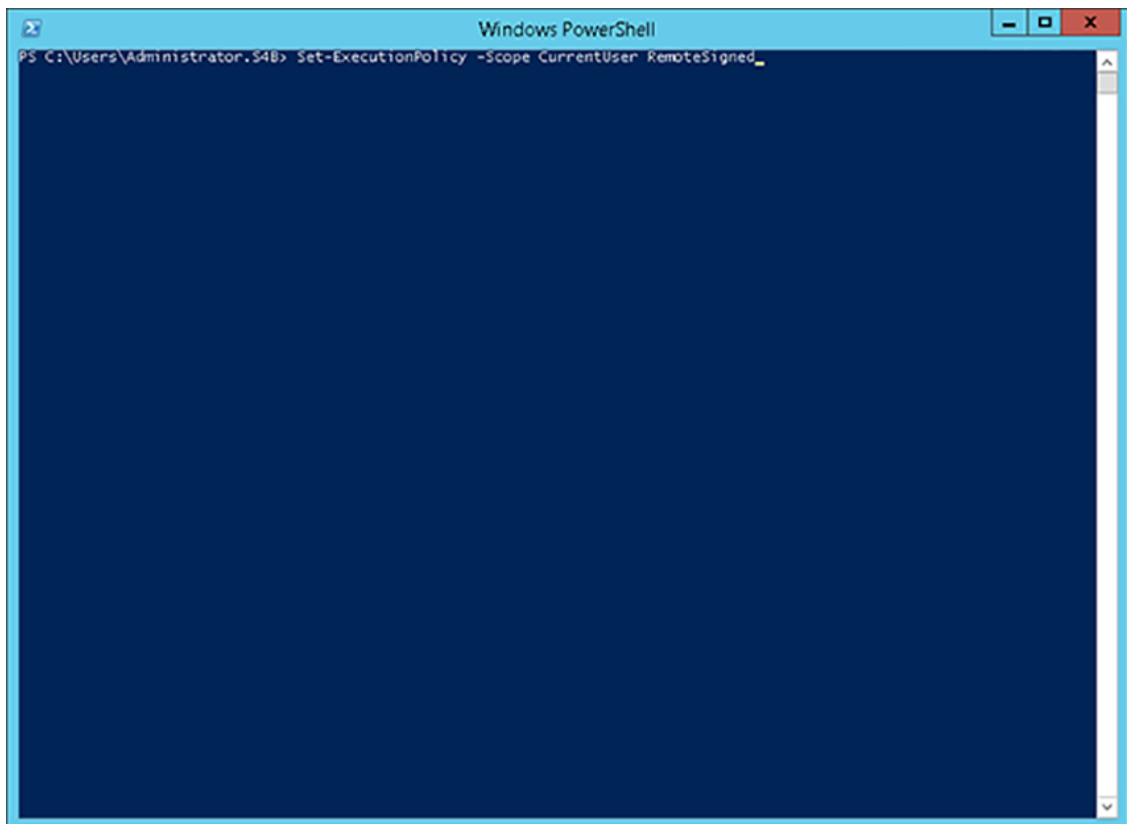
-Enter the credentials for the "SmartTapUser" that you defined on the Domain Controller:



**Figure 8-21: Windows Security**

-Open the Windows PowerShell and set the following Execution Policy for this user:

```
Set-ExecutionPolicy -Scope CurrentUser RemoteSigned
```

**Figure 8-22: Windows PowerShell**



A Domain Admin account may be required to perform Plug-in installation; however, the created “SmartTAPUser” account is recommended to be used to run the Plug-in service.

## Skype for Business Plugin Installation Procedure

This section describes the procedure for installing the Skype for Business plugin.

### ➤ To install the plugin:

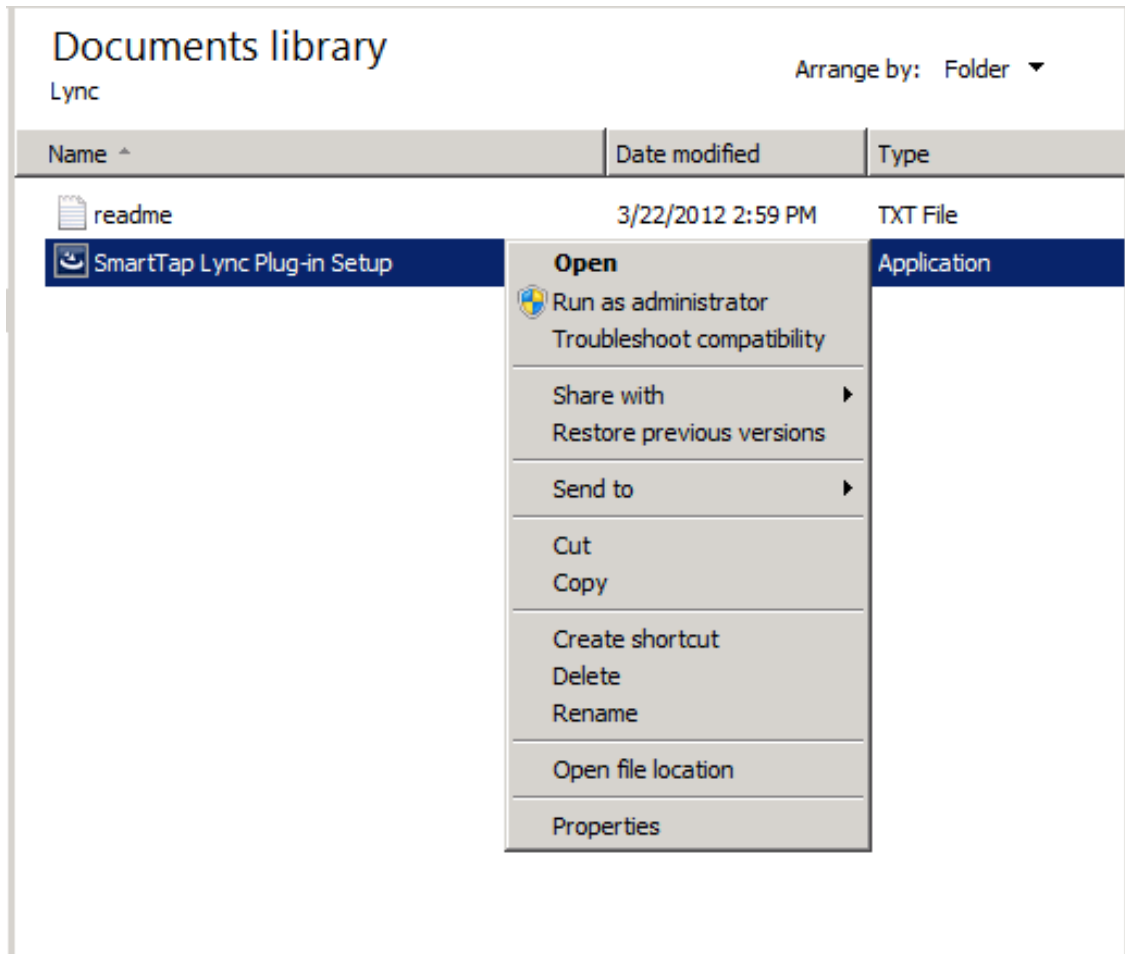
1. Copy the Skype for Business installation application SmartTAP 360° Live <Plugin\_type> Plugin Setup to the FE, SBS or SBA desktop.
  - Where <Plugin\_type> is one of the following:
    - Lync2010
    - Lync2013
    - Skype for Business



AudioCodes recommends enabling the “Computer Browser” service prior to running the installer. Once the installation is complete, the “Computer Browser” service can be disabled.

1. Right-click on the file and select Run as Administrator.

Figure 8-23: Documents Library



2. If you see the warning, "Computer Browser" service is not running as shown below it is highly recommended to cancel the install. Enable the Computer Browser Service then restart the install. You can disable the "Computer Browser" service once install is complete.
3. If you are performing an upgrade and have changed the default values for the following parameters, an informative message is displayed.
  - RecordExternalCallsOnly – If exists and value is true then we prompt
  - recordPSTNCallsOnly – If exists and value is true then we prompt
  - EnableAnnouncements - If exists and value is true then we prompt

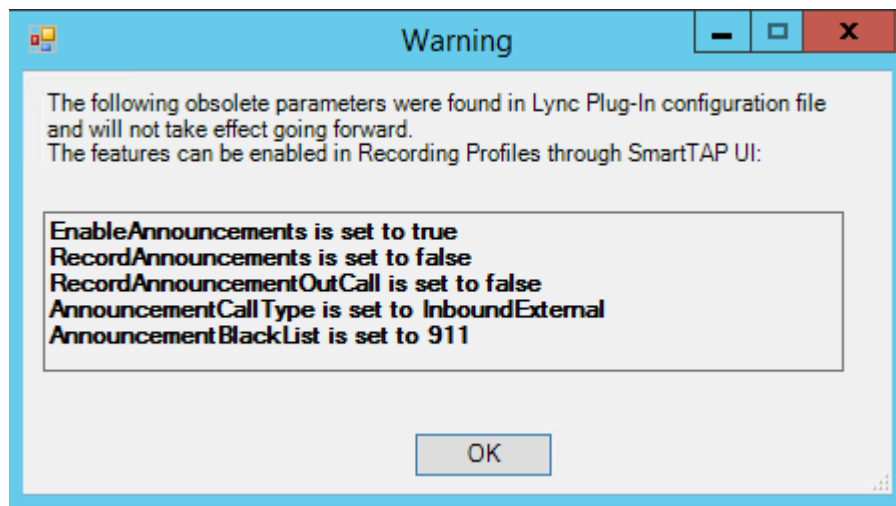
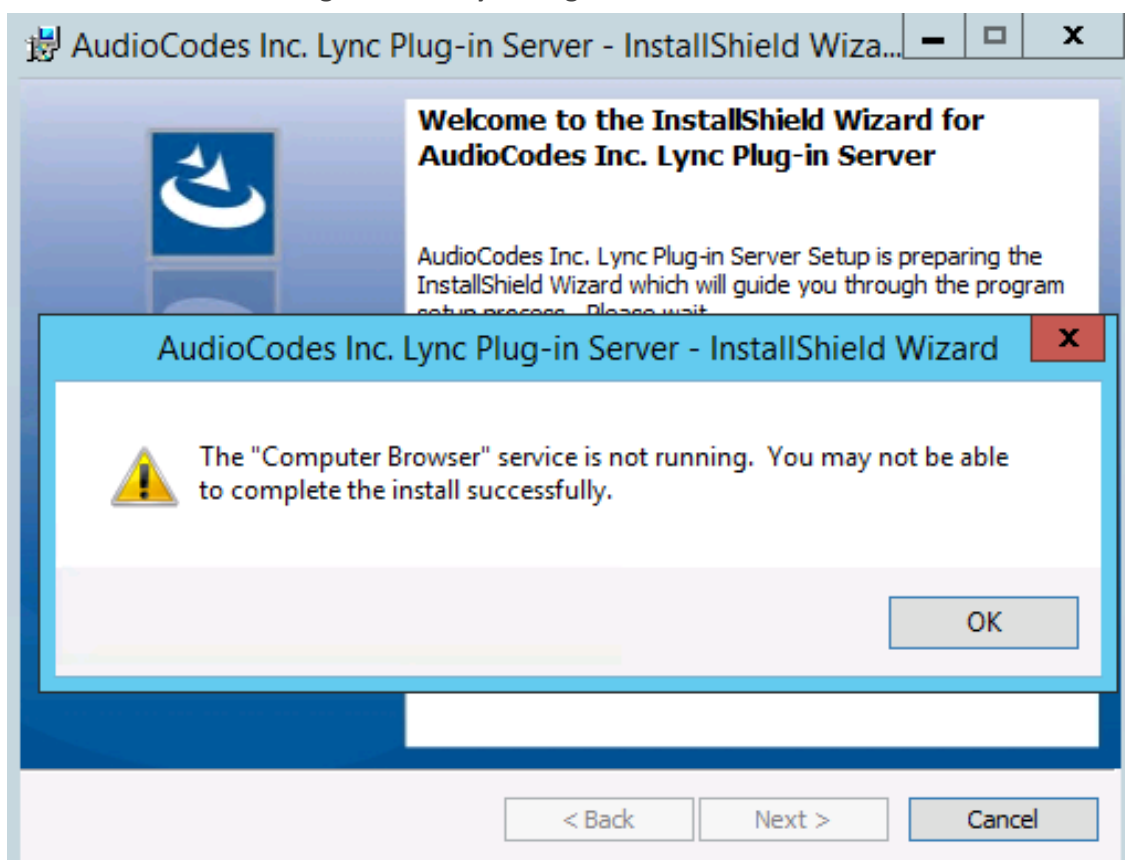
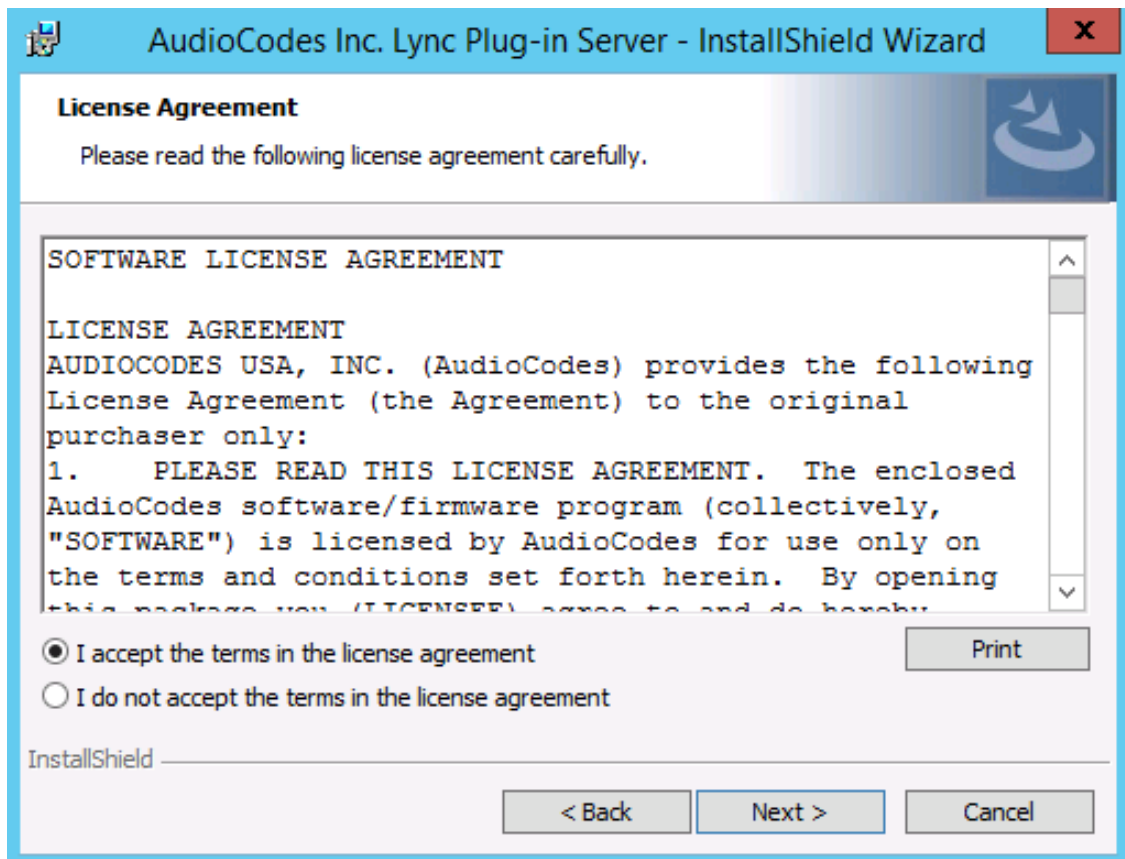


Figure 8-24: Lync Plug-in Server



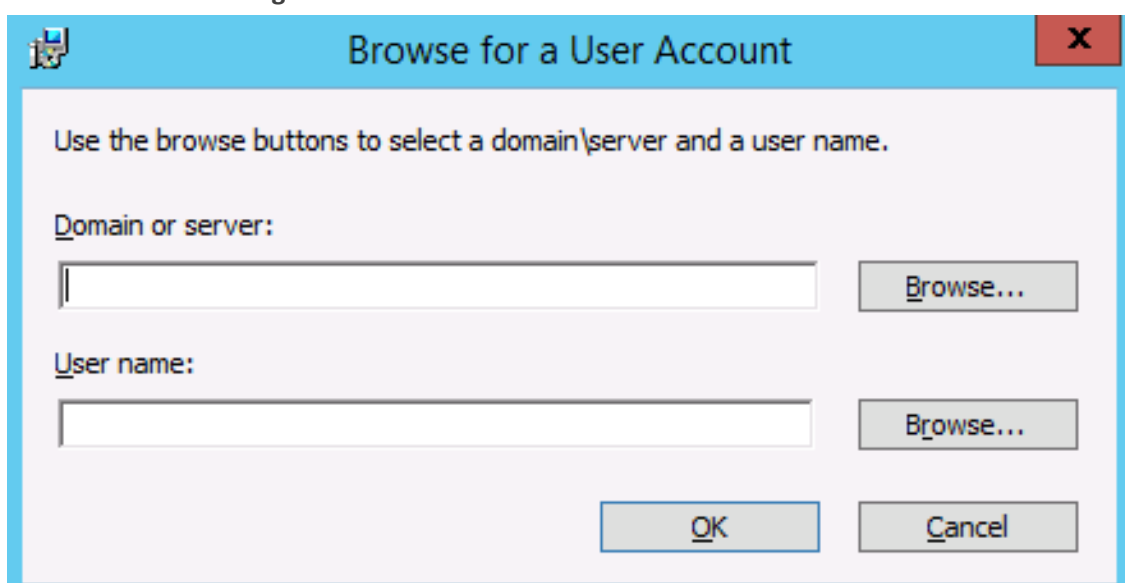
4. Click **Next** to continue.
5. Click the I accept the terms in the license agreement radio button, and then click **Next**.

Figure 8-25: Software License Agreement



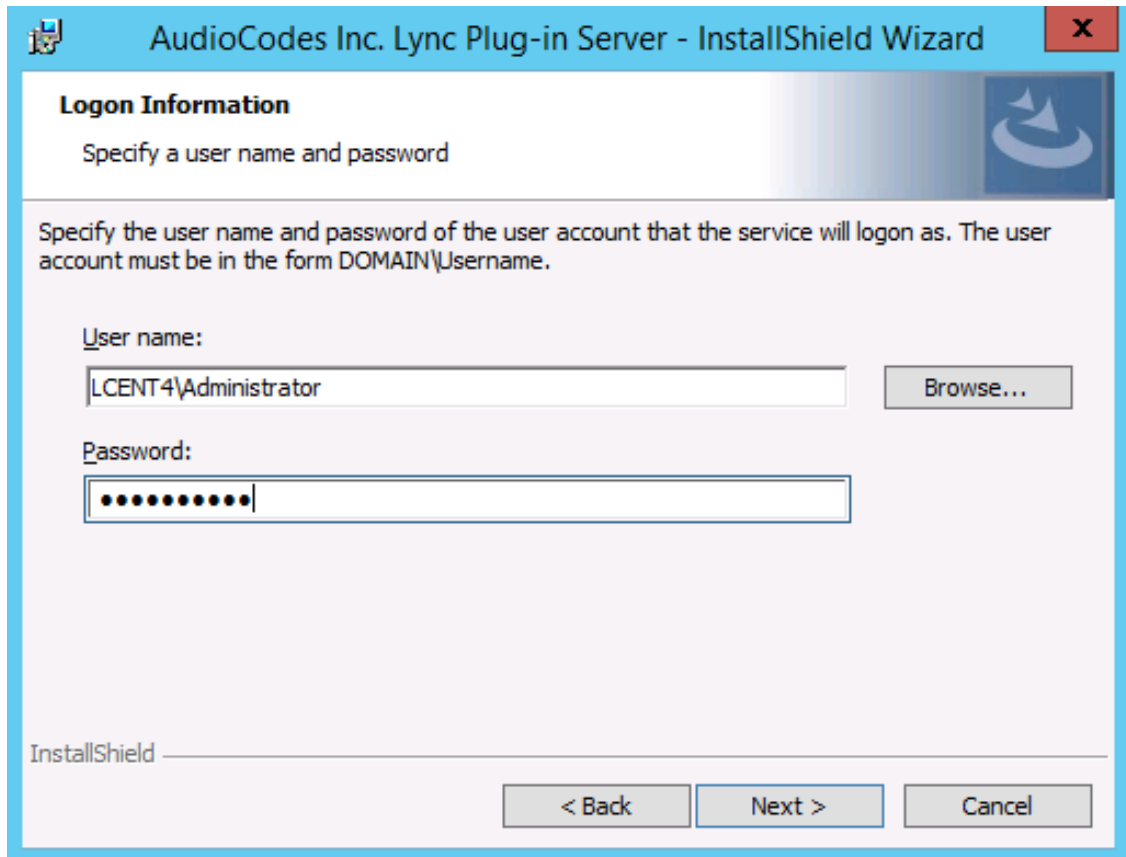
6. Enter the user account that the service will use to log:
  - This user must be the "SmartTAPUser" account created previously on the domain.
  - The user account must be in the form DOMAIN\Username.
  - Optionally click the Browse... button to locate the user in the Active Directory.

Figure 8-26: Browse for a User Account



7. Click **Next** to continue.

Figure 8-27: Logon Information



**AudioCodes Inc. Lync Plug-in Server - InstallShield Wizard**

### Logon Information

Specify a user name and password

Specify the user name and password of the user account that the service will logon as. The user account must be in the form DOMAIN\Username.

User name:

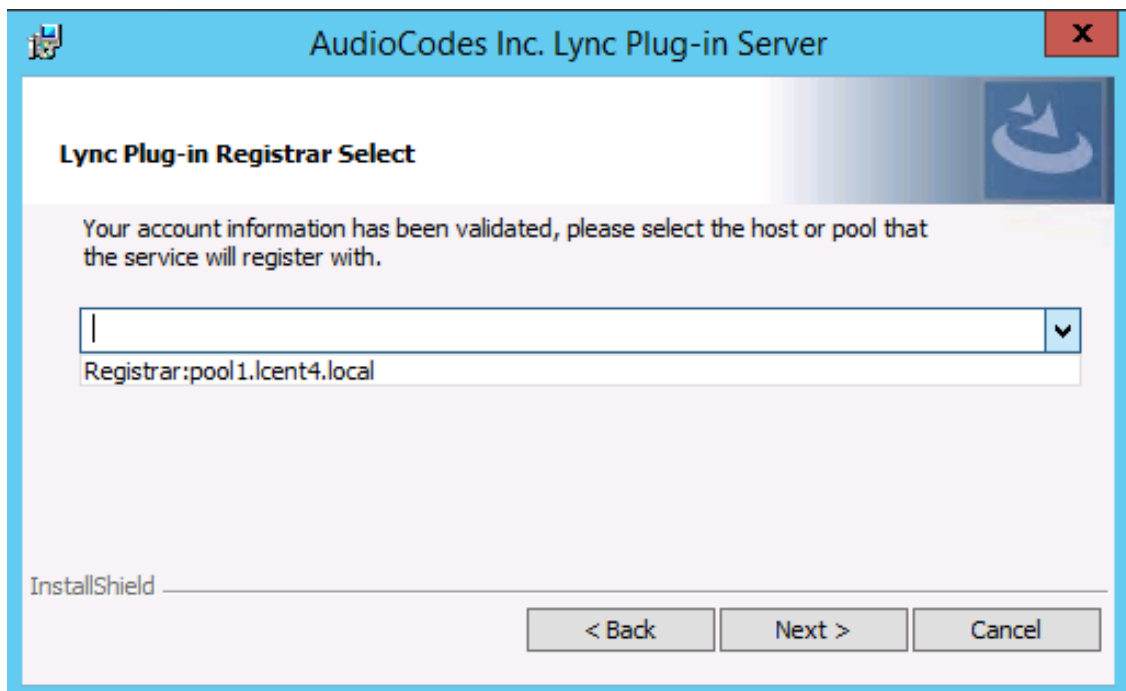
Password:

InstallShield

< Back    Next >    Cancel

8. Select the host or pool that the Plug-in will use to register, and then click Next.

Figure 8-28: Lync Plug-in Registrar Select



**AudioCodes Inc. Lync Plug-in Server**

### Lync Plug-in Registrar Select

Your account information has been validated, please select the host or pool that the service will register with.

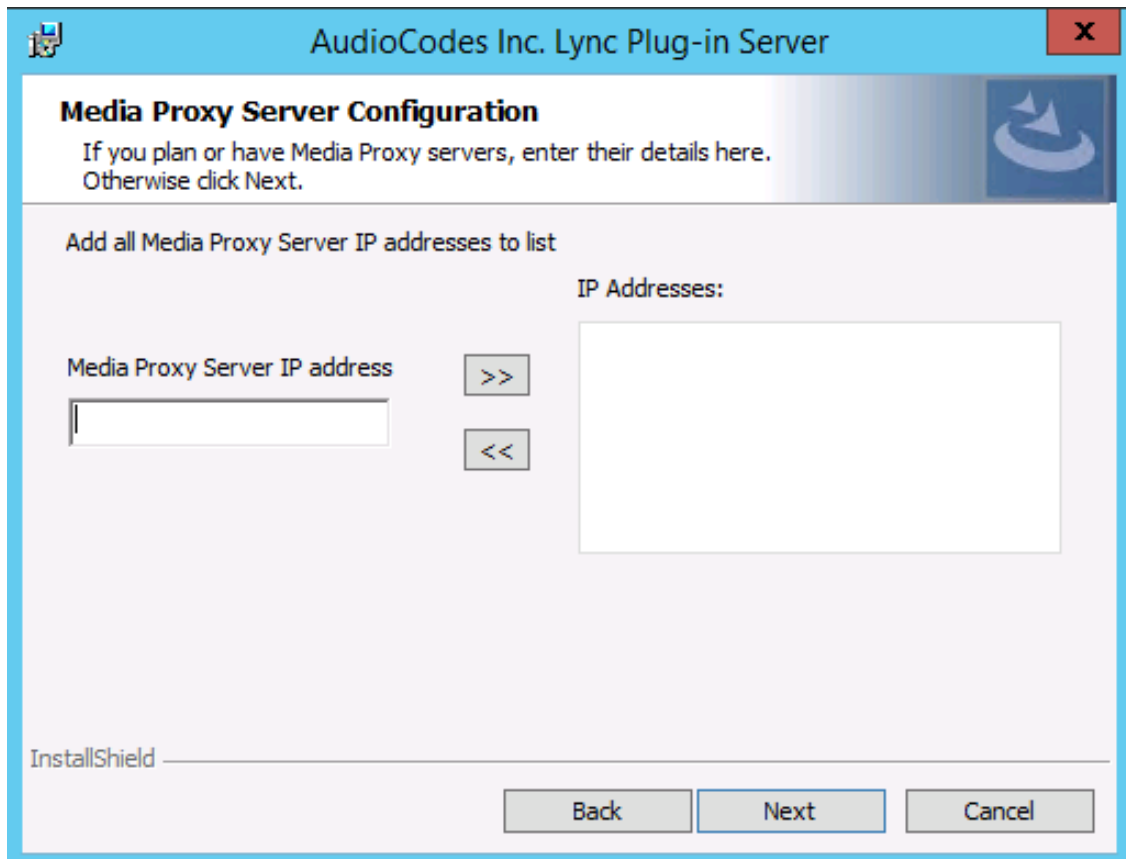
InstallShield

< Back    Next >    Cancel

9. Click **Next**.

10. Enter IP addresses of Media Proxy servers in case the Media Proxy recording method is utilized for the SmartTAP 360° Live installation, otherwise leave the fields empty.

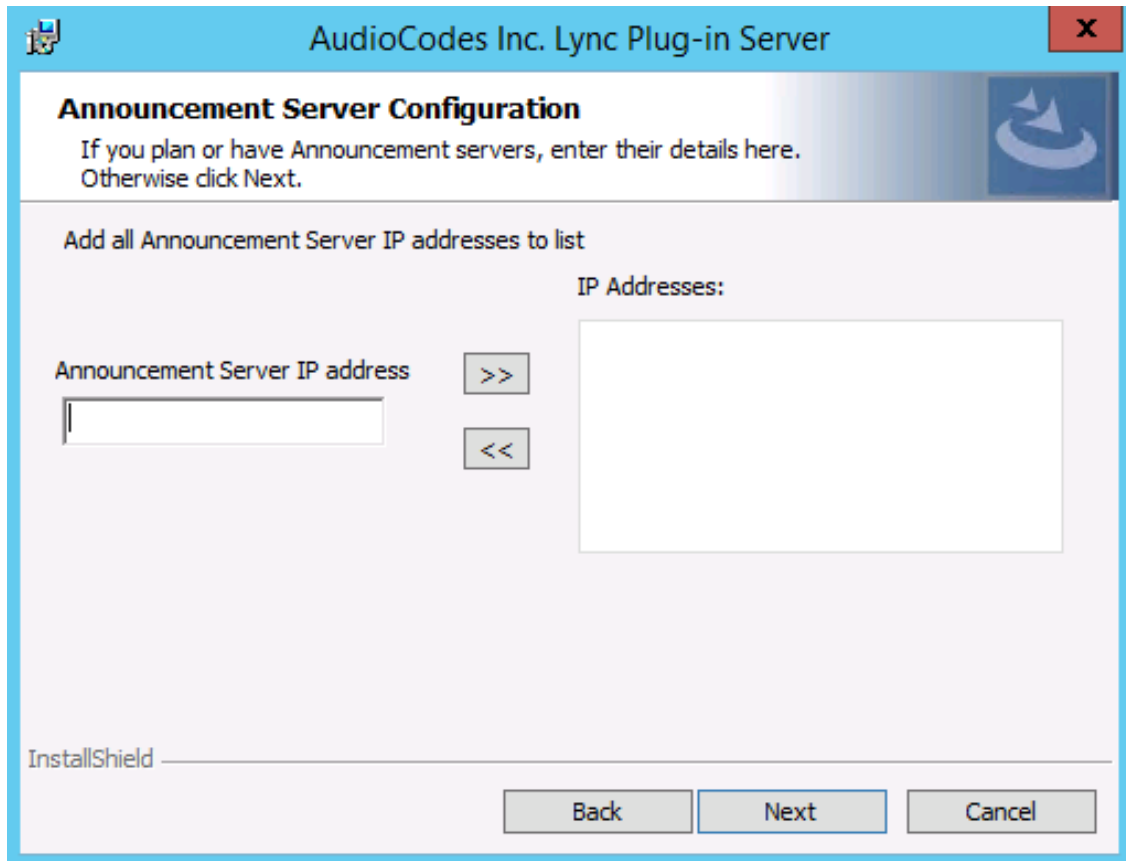
Figure 8-29: Media Proxy Server Configuration



The screenshot shows a dialog box titled "AudioCodes Inc. Lync Plug-in Server" with a close button (X) in the top right corner. The main heading is "Media Proxy Server Configuration". Below the heading, there is a sub-heading and instructions: "Media Proxy Server Configuration" followed by "If you plan or have Media Proxy servers, enter their details here. Otherwise click Next." To the right of this text is a blue circular icon with a white arrow. Below the instructions, the text "Add all Media Proxy Server IP addresses to list" is displayed. Underneath, there is a section for "IP Addresses:" which contains a large empty text box. To the left of this box is a smaller input field labeled "Media Proxy Server IP address" with a vertical cursor. To the right of this input field are two buttons: ">>" (to add the address to the list) and "<<" (to remove the address from the list). At the bottom left of the dialog, the "InstallShield" logo is visible. At the bottom right, there are three buttons: "Back", "Next" (which is highlighted with a blue border), and "Cancel".

11. Click **Next**.
12. Enter IP addresses of Announcement servers in case SmartTAP 360° Live Announcement servers are installed, otherwise leave the fields empty.

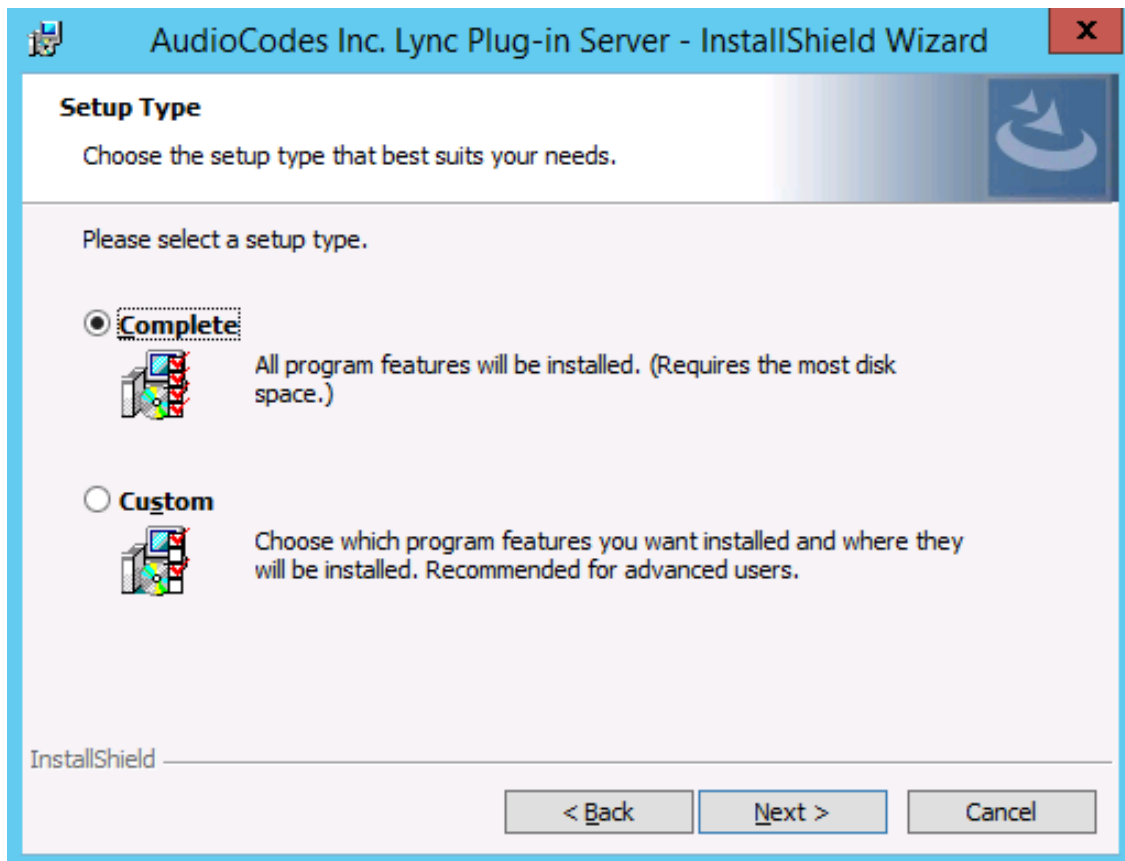
Figure 8-30: Announcement Server Configuration



13. Click **Next**. Click the Complete installation to install the plugin in the default path on C: drive, otherwise click Custom to change the install path.



Figure 8-31: Setup Type



14. Click **Next**.
15. Click **Install** to install the plugin.
16. Click **Finish** to complete installation.



If the plugin installation fails, refer to [Troubleshoot Skype for Business Recording](#) on page 203

## Installing Call Delivery for Skype for Business (IP-based Recording)

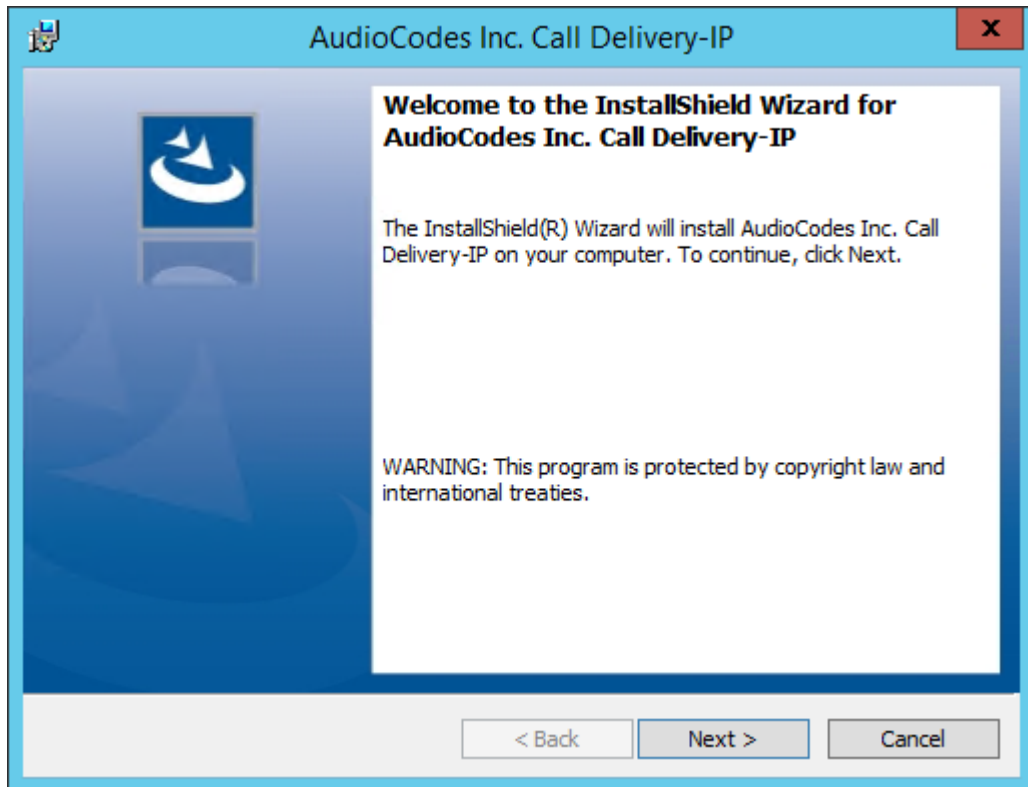


It is highly recommended to configure the Firewall with the required ports to ensure proper communication prior to the software installation. See [Firewall Configuration](#) on page 59.

### ➤ To install IP-based recording (Skype for Business):

1. Click **Next** to continue.

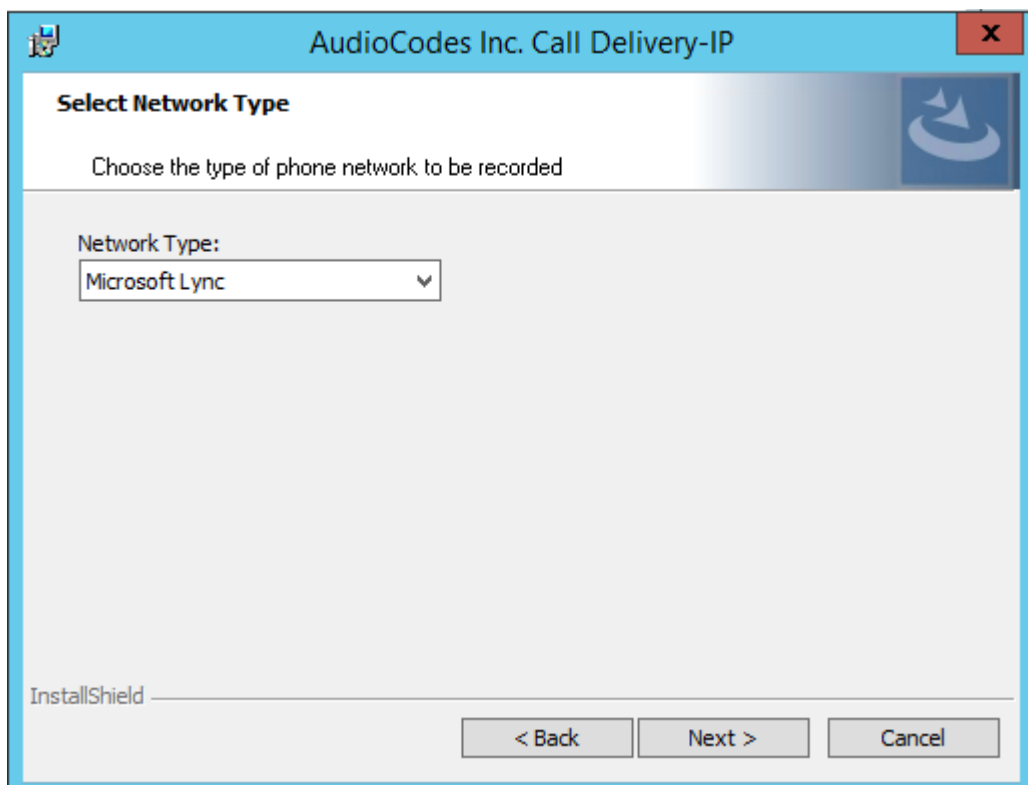
Figure 8-32: Call Delivery-IP



Assuming you are setting up for a Skype for Business installation, select "Microsoft Lync" when prompted for the network type.

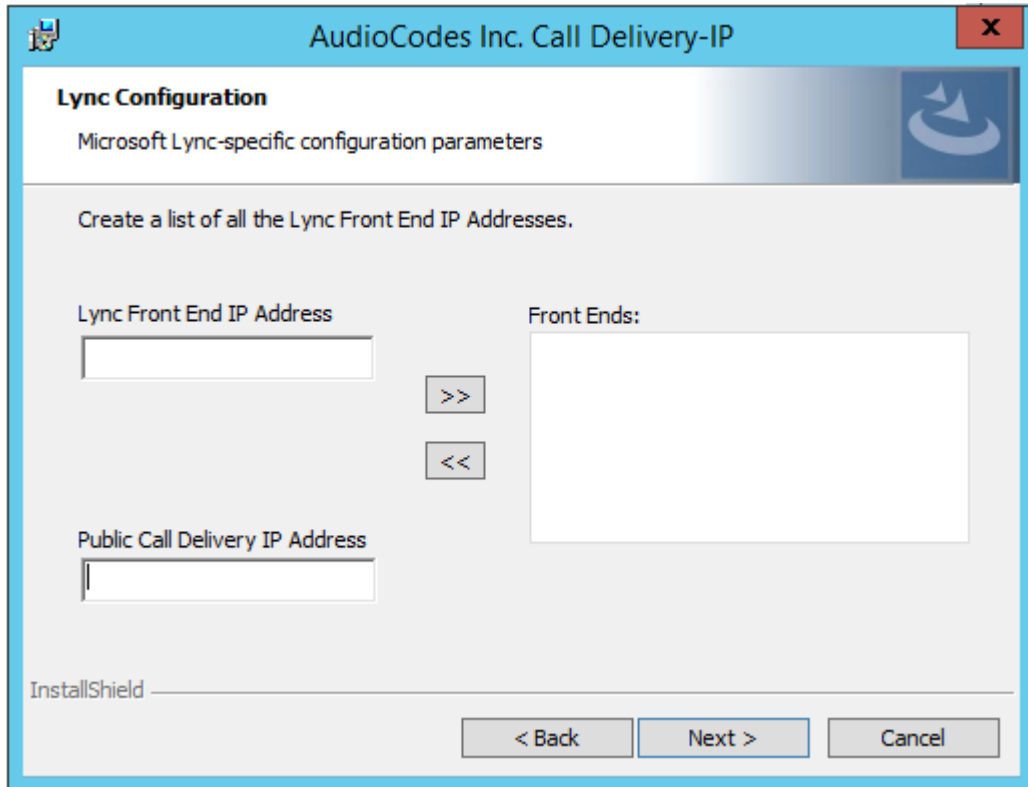
2. Click **Next** on the Server IP Setup.

Figure 8-33: Network Type



3. Add each of your Skype for Business Front End IP addresses to the “Lync Front End IP Address” field, and click on the right arrow, to add it to the Front Ends list on the right.
4. Under “Public Call Delivery IP Address”, type in the IP address of the computer you are currently installing the Call Delivery component on.
5. Click **Next** on the Server IP Setup.

Figure 8-34: Lync Configuration



6. To capture the audio:
  - See Section [Monitoring](#) below:
    - ◆ Local – Port Mirroring
    - ◆ Remote – Conference or Mediation Server
  - See Section [Edge](#) on page 102
  - See Section [Configuring Media Proxy for Call Delivery-IP](#) on page 104.
7. Click **Next** to select the Recording Type.

## Monitoring

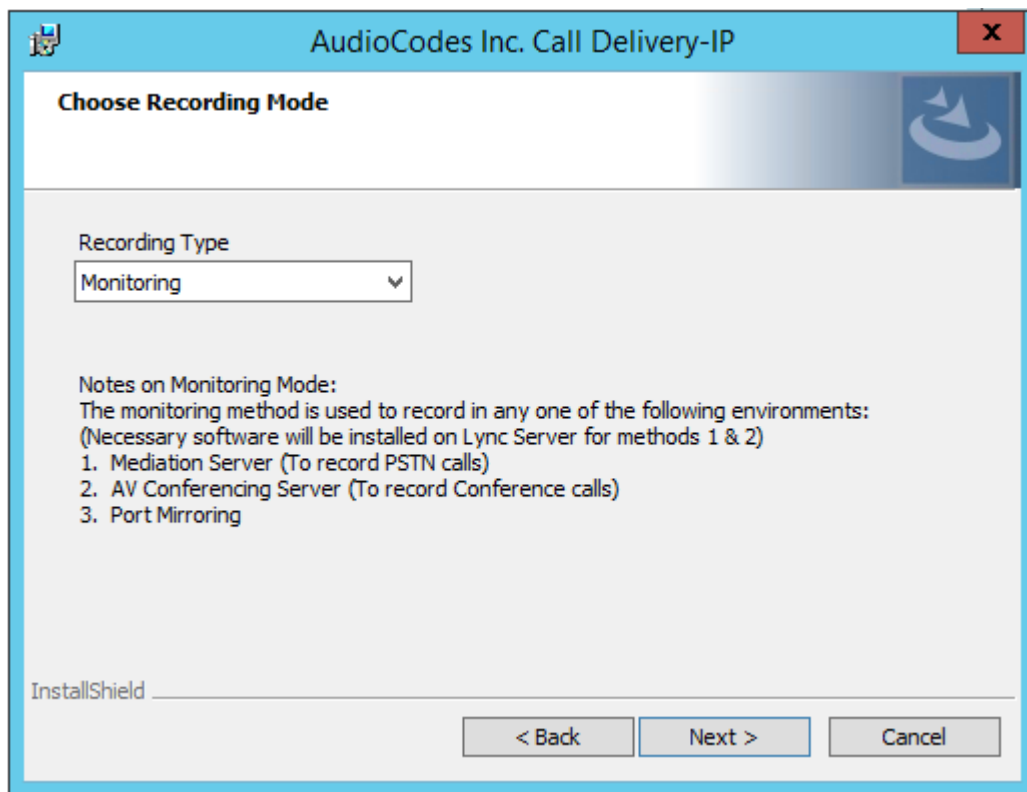
This section describes how to configure the location for capturing monitored recording:

- **Local** is typically used with Port Mirroring in a Skype for Business environment.
- **Remote** is typically used when Media Delivery is installed on Mediation or AV Conferencing server to capture SRTP.

➤ **To capture monitored recordings locally:**

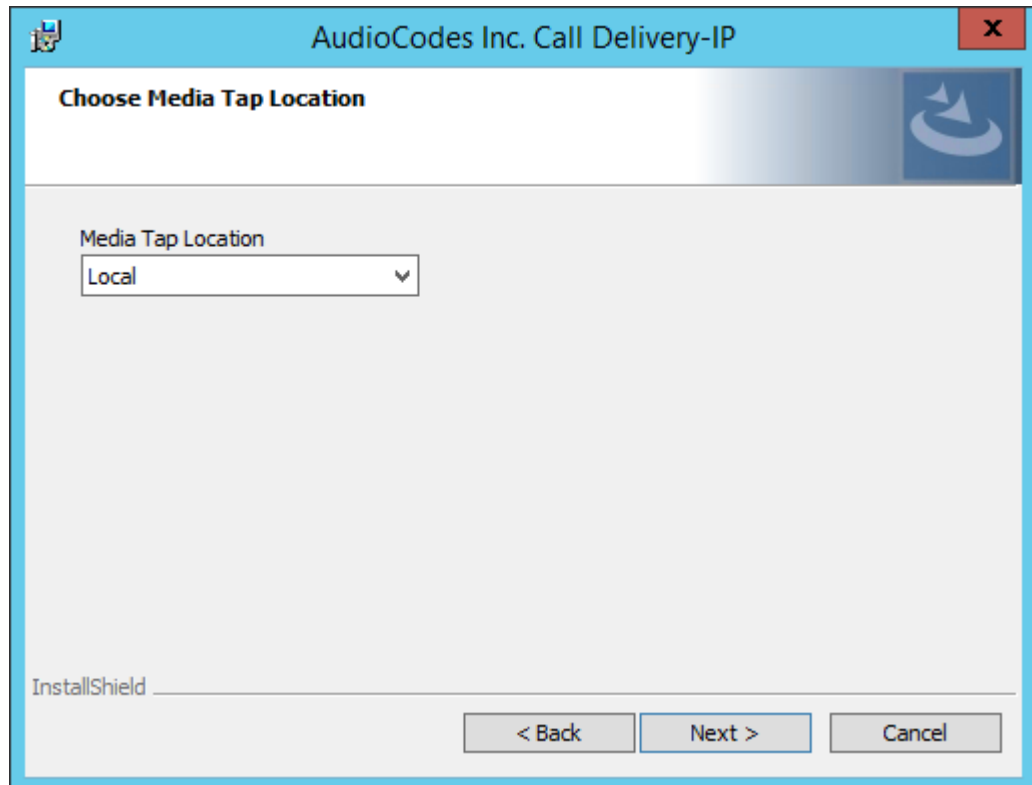
1. From the Recording Type drop-down list, select **Monitoring**.

**Figure 8-35: Choose Recording Mode**



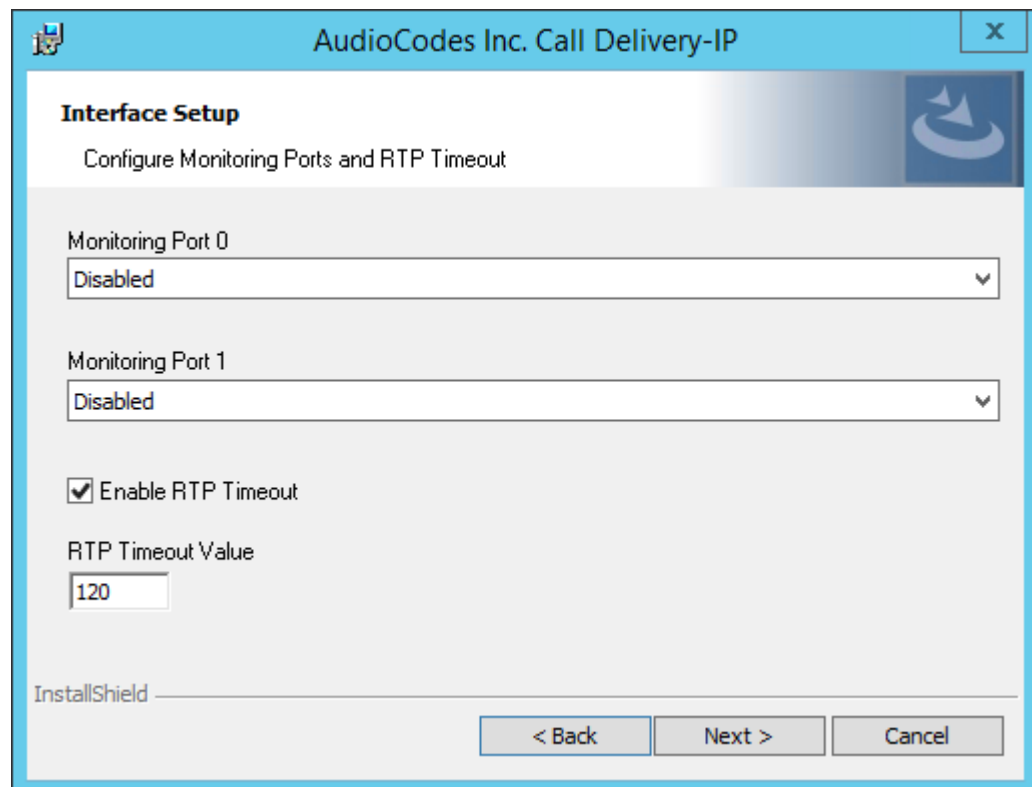
2. From the Media Tap Location drop-down list, select **Local**.

Figure 8-36: Choose Media Tap Location



3. Select the appropriate interfaces from the dropdown menu in the Interface Setup screen.

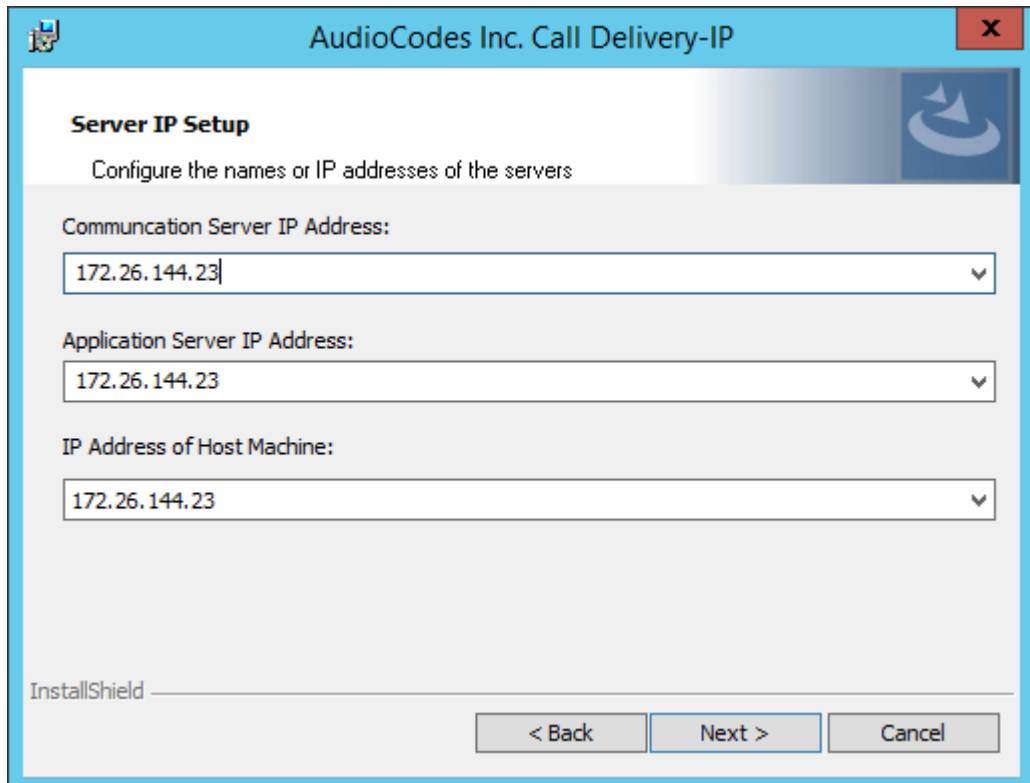
Figure 8-37: Interface Setup



In case of distributed or remote branch deployment, enter the IP address of the Application Server (AS), Communication Server (CS), and IP address of the Host Machine.

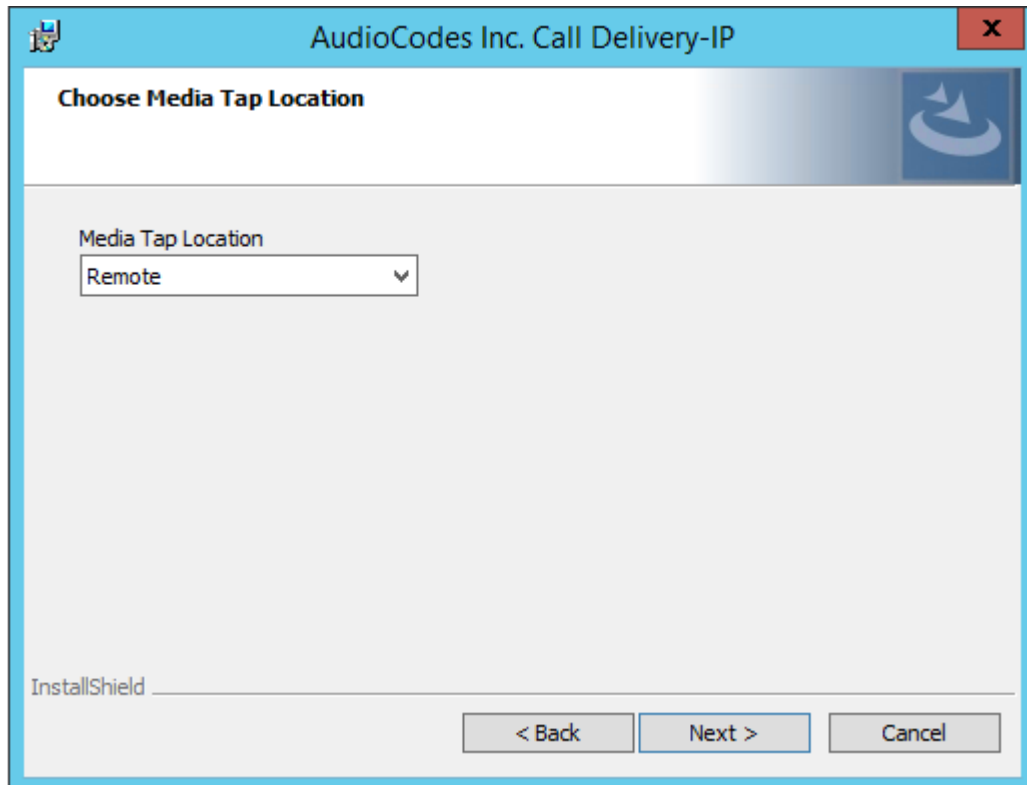
In case of all-in-one deployment, use the drop down list and choose the SmartTAP IP address.

Figure 8-38: Server IP Setup



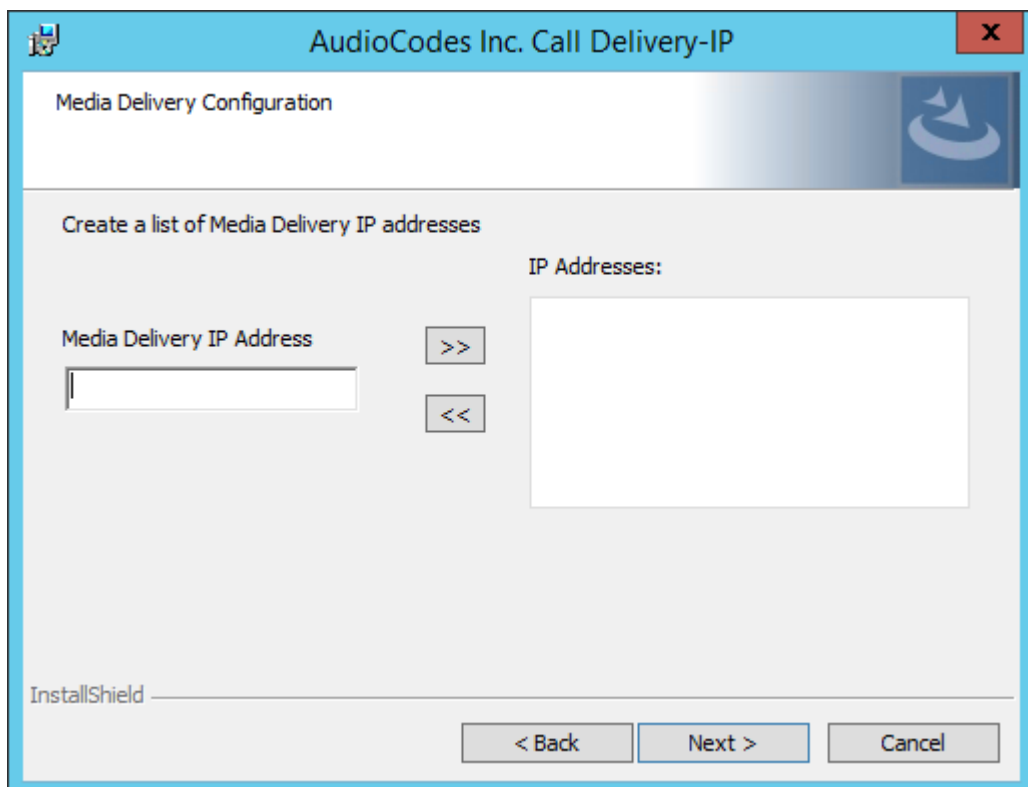
4. Click **Next** on the Server IP Setup.
  5. Click **Next** on the Setup Type screen.
  6. Click **Install** on the install screen.
  7. Click **Finish** to finish.
- **To capture monitored recordings remotely:**
1. From the Media Tap Location drop-down list, select **Remote**.

Figure 8-39: Choose Media Tap Location



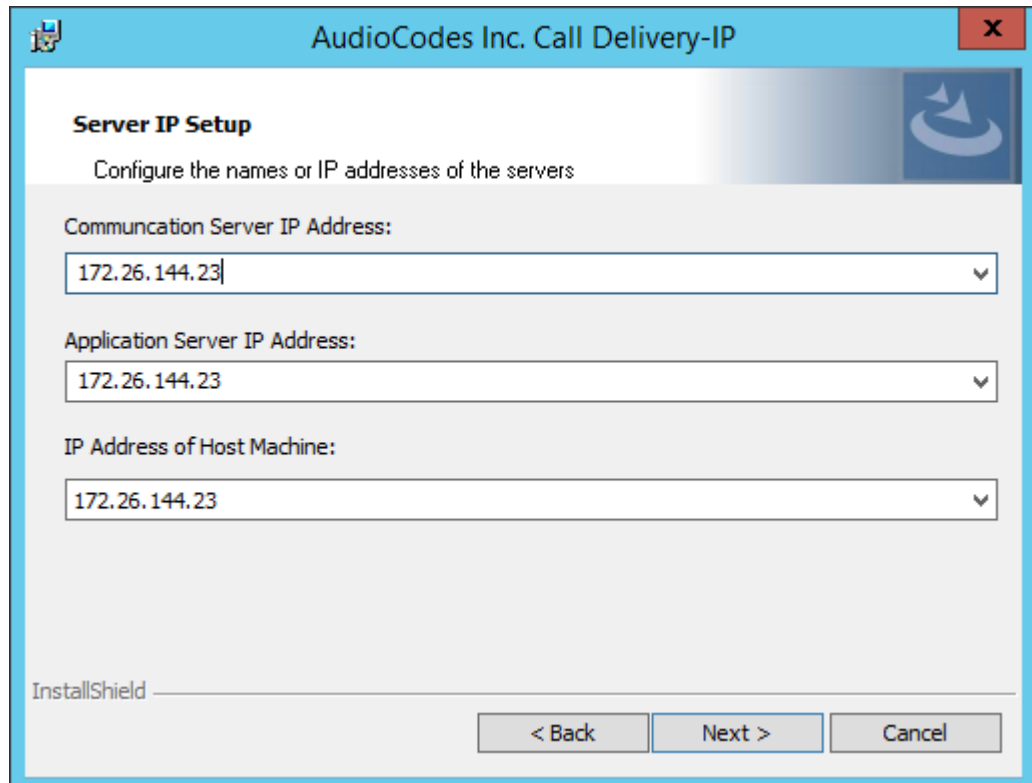
2. Specify the IP Address of the Media Delivery Host machine and click >> to add it to the IP Address list.
3. Repeat for each Host machine where Media Delivery is installed.

Figure 8-40: Media Delivery Configuration



In case of distributed or remote branch deployment, type in the real IP address of the Application Server (AS), Communication Server (CS), and IP address of the Host Machine (don't type in 127.0.0.1). In case of all-in-one deployment use the AS, CS, and the Host machine parameters drop down list and choose the SmartTAP IP address.

Figure 8-41: Server IP Setup



4. Click **Next** on the Server IP Setup.
5. Click **Next** on the Setup Type screen.
6. Click **Install** on the install screen.
7. Click **Finish**.

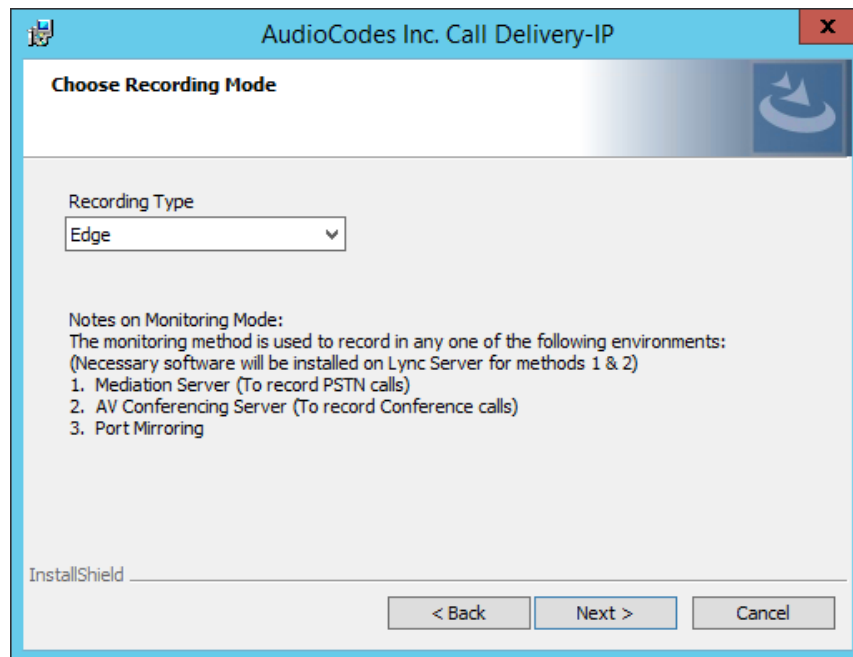
## Edge

The Media Delivery component is installed on each Edge server in the Pool. Use the Edge solution to record any call scenario in a Microsoft environment.



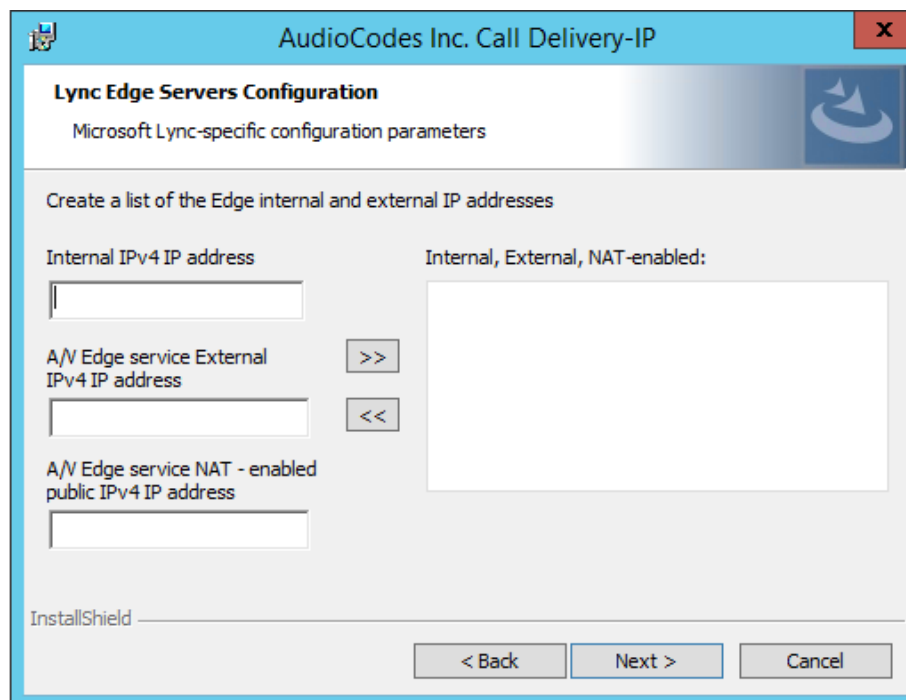
➤ To install the Edge server:

Figure 8-42: Choose Recording Mode



1. Click **Next** to select Record Type “Edge”.

Figure 8-43: Lync Edge Servers Configuration

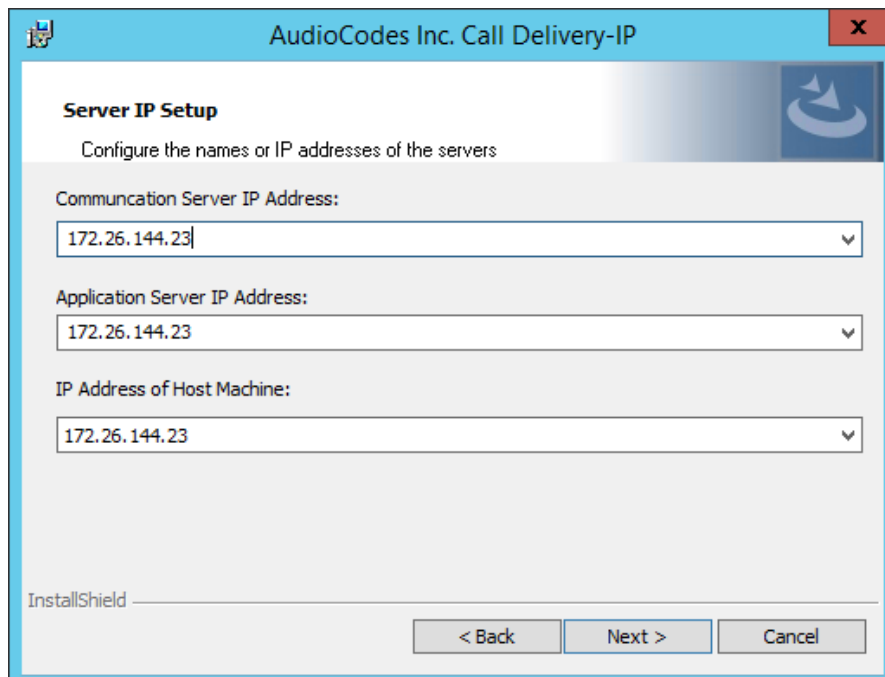


2. Specify the Internal, External & NAT IP then click the >> to add to list.
3. Repeat for each Edge server in the pool.

In case of distributed or remote branch deployment, type in the real IP address of the Application Server (AS), Communication Server (CS), and IP address of the Host Machine

(don't type in 127.0.0.1). In case of all-in-one deployment use the AS, CS, and the Host machine parameters drop down list to choose the SmartTAP IP address.

**Figure 8-44: Server IP Setup**



4. Click **Next** on the Server IP Setup.
5. Click **Next** on the Setup Type screen
6. Click **Install** on the install screen
7. Click **Finish**.

## Firewall Exceptions

Firewall exceptions are REQUIRED for this solution to work. See [Firewall Configuration](#) on page 59 [Firewall Configuration](#) on page 59 for the required exceptions.

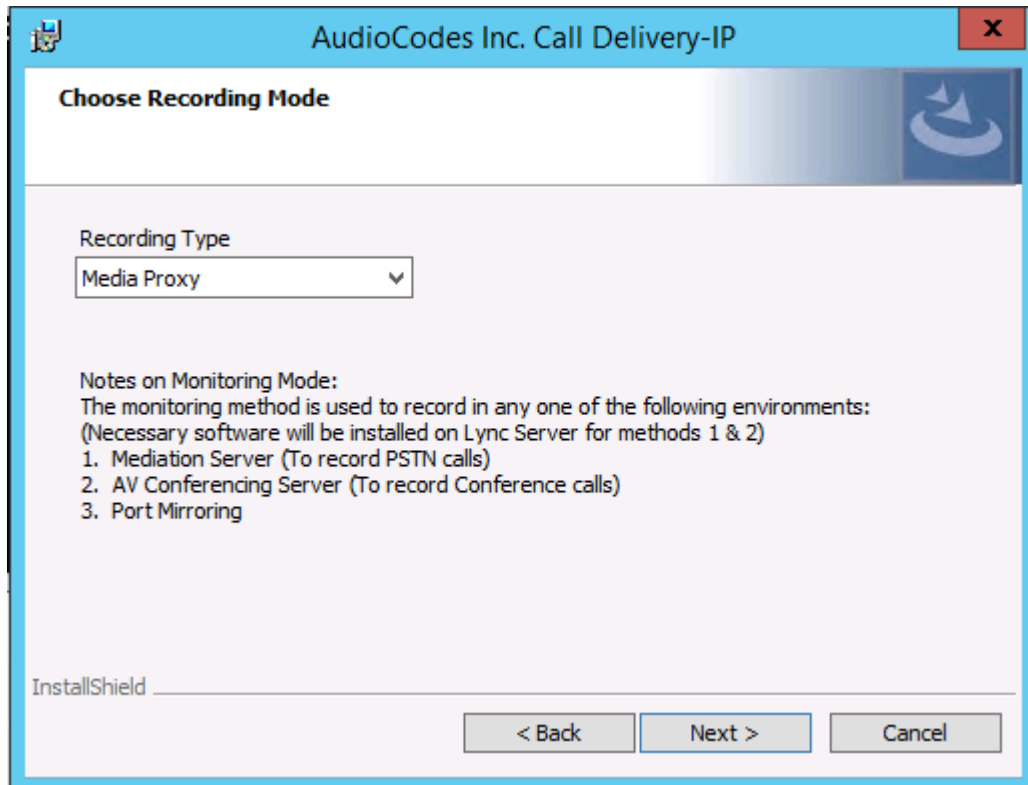
## Configuring Media Proxy for Call Delivery-IP

The SmartTAP Media Proxy is a stand-alone server designed to relay the SRTP “Voice” to the final destination providing SmartTAP 360° Live with a centralized point to capture the audio. The SmartTAP Skype for Business plugin on the FE / SBA will pin the media through the proxy so SmartTAP 360° Live has a central point to capture the SRTP for Internal, PSTN, and Conference calls.

### ➤ To configure Media Proxy for Call Delivery-IP:

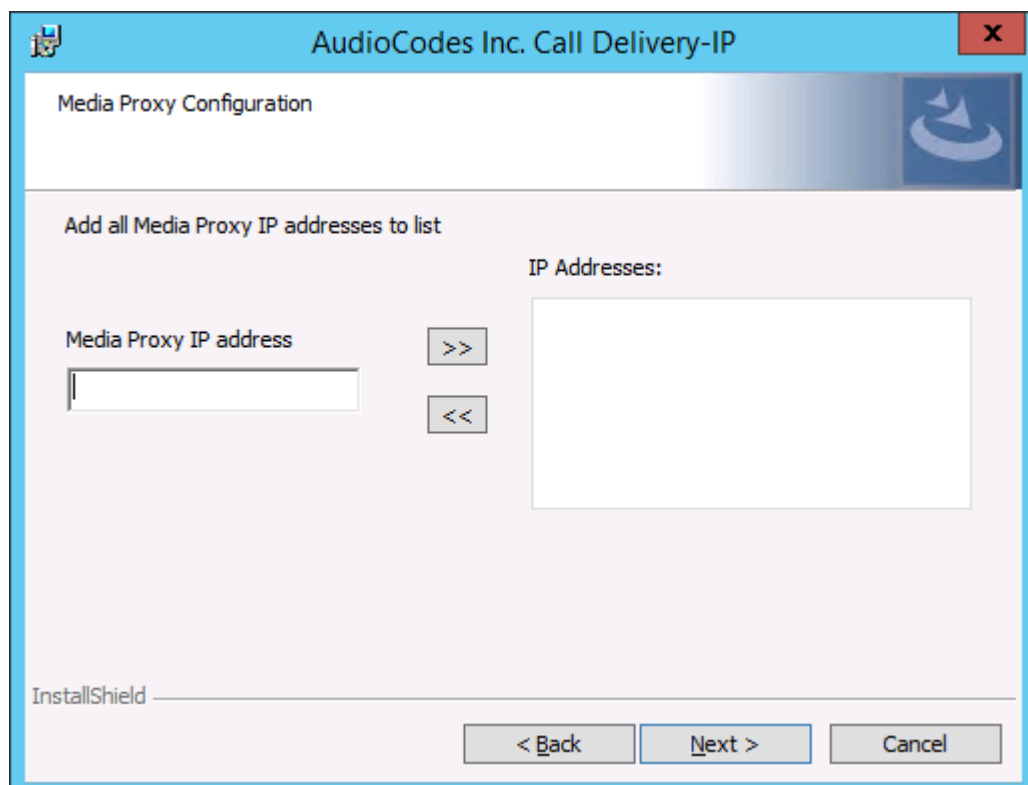
1. Select the Media Proxy recording type.

Figure 8-45: Choose Recording Mode – Media Proxy



2. Specify the IP Address of the Media Proxy server.
3. Specify the Media proxy port to use (default 10123).

Figure 8-46: Media Proxy Configuration



You can combine the Media proxy model that records Internal, PSTN and Conference calls with the Edge recording model, which will record (Remote, Federated and Mobile calls). If you intend to use the Edge model in conjunction with the Media proxy, provide the Edge details in the following screen and install the Media Delivery software on the Edge server:

1. Provide the Internal & External Edge IP.
2. Add the NAT IP if configured.

Figure 8-47: Lync Edge Servers Configuration

**AudioCodes Inc. Call Delivery-IP**

**Lync Edge Servers Configuration**  
Microsoft Lync-specific configuration parameters

Create a list of the Edge internal and external IP addresses

Internal IPv4 IP address

A/V Edge service External IPv4 IP address

A/V Edge service NAT - enabled public IPv4 IP address

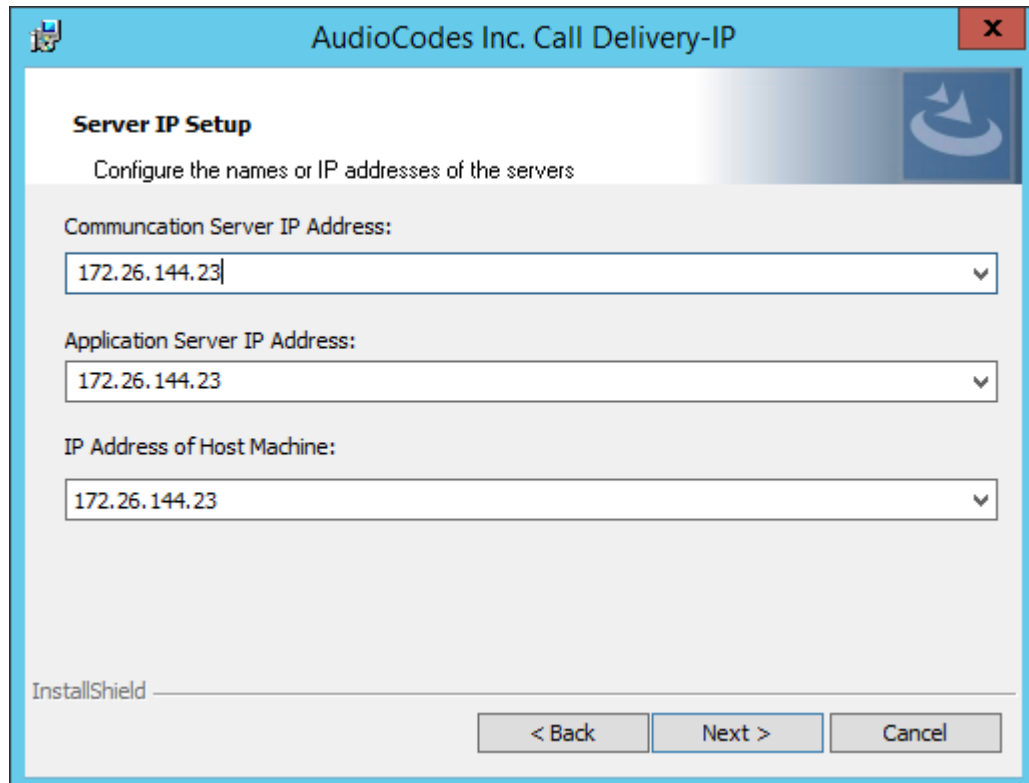
Internal, External, NAT-enabled:

< Back   Next >   Cancel

InstallShield

3. Specify the real IP addresses of the SmartTAP Communication Server and Application Server.
4. Select the NIC interface of the local server.

Figure 8-48: Server IP Setup



5. Select Complete setup type, and then click **Next** to continue.
6. Click **Install** to complete installation.

### Configuring Call Delivery for Skype for Business

The Voip.cfg file located in the target path of the Call Delivery will automatically be configured during the SmartTAP software installation. Remember to restart the service if any changes are made manually to the voip.cfg file.

Default Path: ..... \AUDIOCODES\SmartTAP\CD-IP\Config\Voip.cfg



Do not make changes to the Voip.cfg unless the IP address assigned to the FE/SBA or the SmartTAP server has changed.

Figure 8-49: Description of the Skype for Business Specific Changes

Field	Default	Description
MICROSOFT=[...]	N/A	The MICROSOFT field defines the CD configuration specific to Skype for Business recording. The # must be removed from every line starting with MICROSOFT line and the matching ] at the end of the definition
SWSERVERPORT	TCP, 9090	

Field	Default	Description
CC	ON	
PLUGINLIST	blank	Add list of Front End Server IP Addresses in the pool separated by “,” connecting to this Call Delivery service. Each server in pool should be listed.
SWSERVER	blank	Set to SmartTAP server IP where Call Delivery resides
RECORDINGTYPE	0	<ul style="list-style-type: none"> <li>■ 0 = Mediation, Conference server or Port Monitoring</li> <li>■ 3 = Use with Edge</li> <li>■ 4 = Use the Media Proxy and Edge (Optional)</li> </ul>
MEDIAPROXYURL	blank	IP Address:Port of Media Proxy server (Port default 10123)

Voip.cfg changes in bold below:

```

MICROSOFT =
[
  SWSERVERPORT=TCP,9090
  CC=ON
  PLUGINLIST=Front End / SBA IP:9901
  SWSERVER=SmartTAP Server IP
  RECORDINGTYPE=# # 0 - monitoring(default), 3 - EdgeProxy (used on the
Edge server), 4 - MediaProxy
  MEDIAPROXYURL=http://IP:10123 # required if RECORDINGTYPE=4
(MediaProxy)

```

## Installing Media Proxy Server for Skype for Business

The Media Proxy (MP) is used specifically in Microsoft Skype for Business environment as a voice media proxy. The SmartTAP Skype for Business plugin on the FE will redirect the targeted SRTP “voice” only to the Media Proxy, which then sends the voice on to the original destination. A copy of the SRTP “voice” call that traverses the MP is sent to the SmartTAP server for long-term storage.

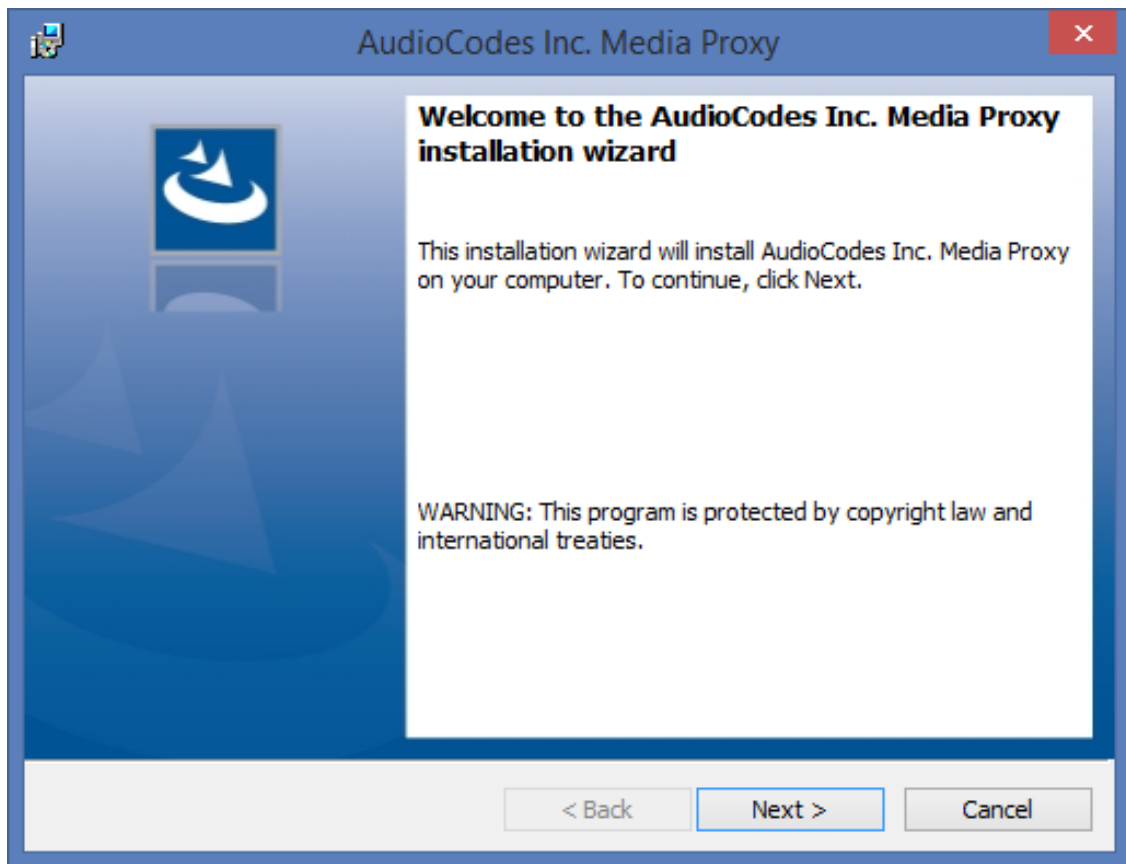


- It is highly recommended to configure the Firewall with the required ports to ensure proper communication prior to the software installation. See [Firewall Configuration](#) on page 59.
- Before proceeding, ensure that you have noted the installation requirements (see [Before Installing Microsoft Skype for Business Components](#) on page 73)

➤ **To install the Media Proxy:**

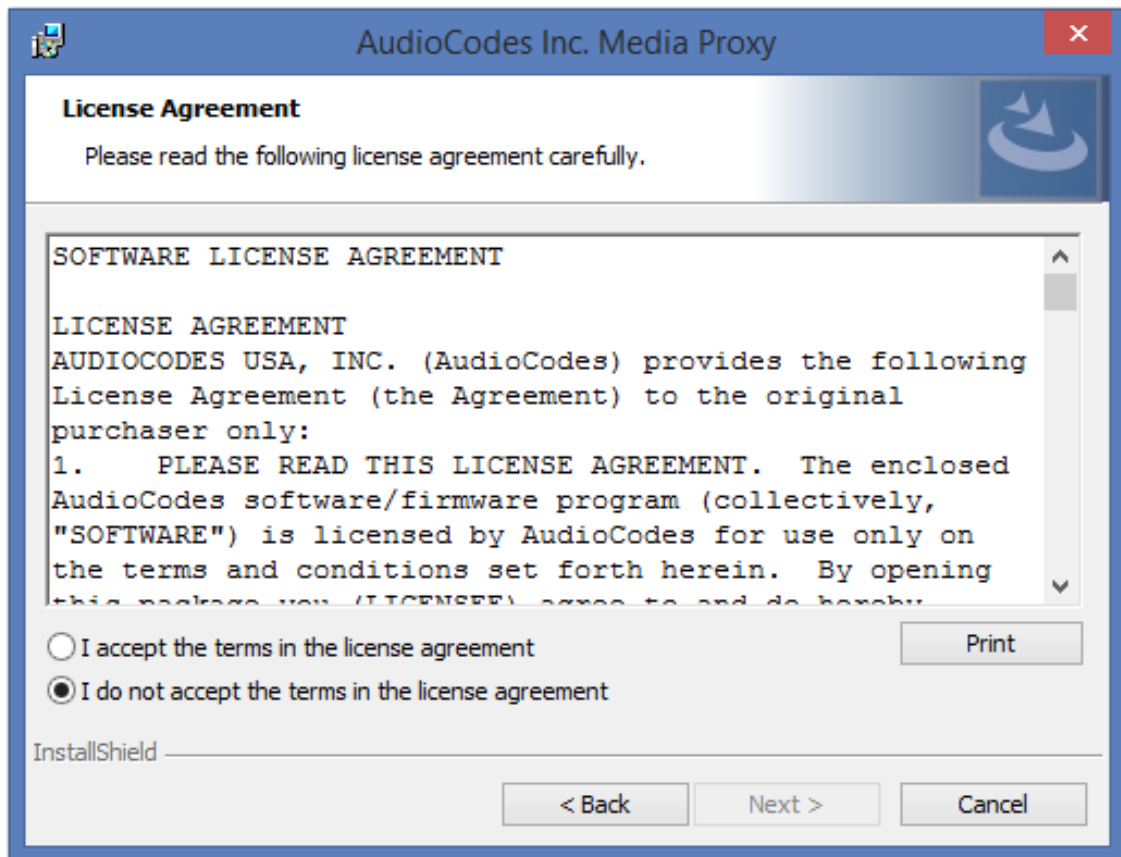
1. When the Media Proxy installation wizard starts, click **Next** to install.

**Figure 8-50: Media Proxy Welcome**



If you are installing from a Suite, the following screen may not be displayed.

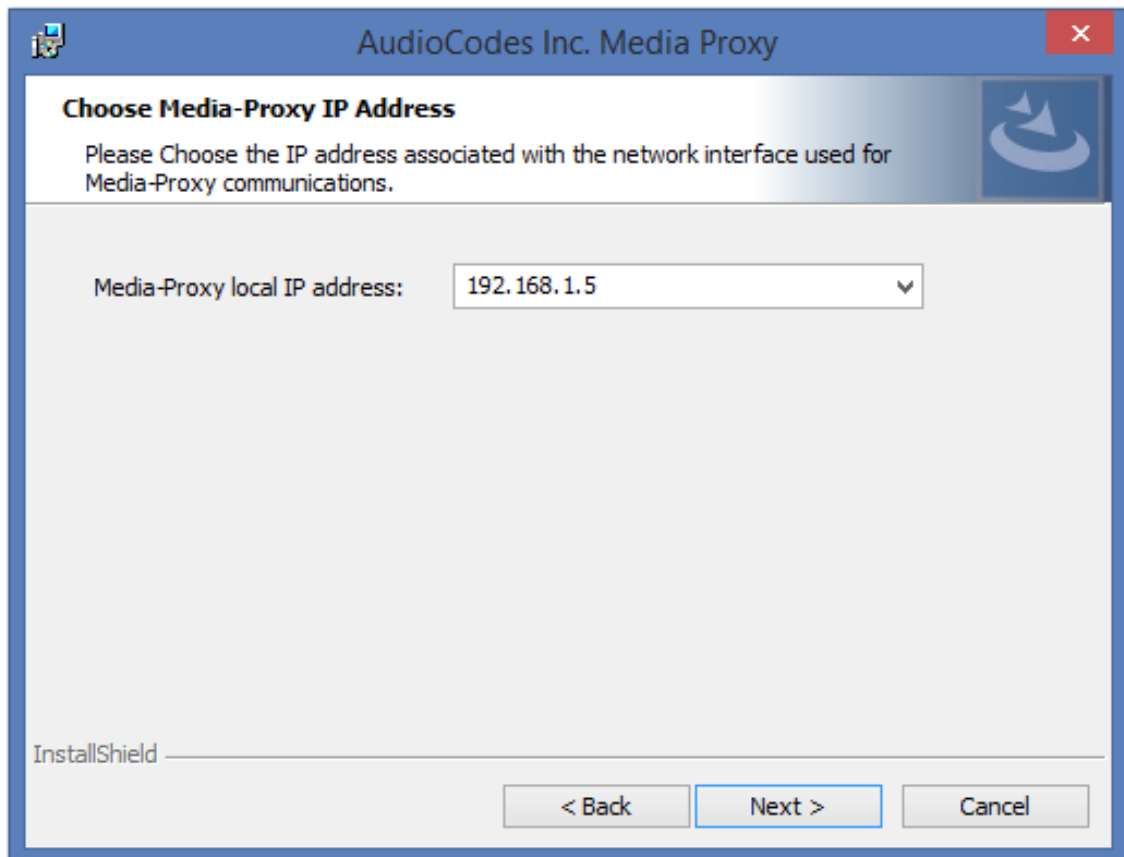
Figure 8-51: License Agreement



2. Select the "I accept the terms in the license agreement" radio button and click Next.

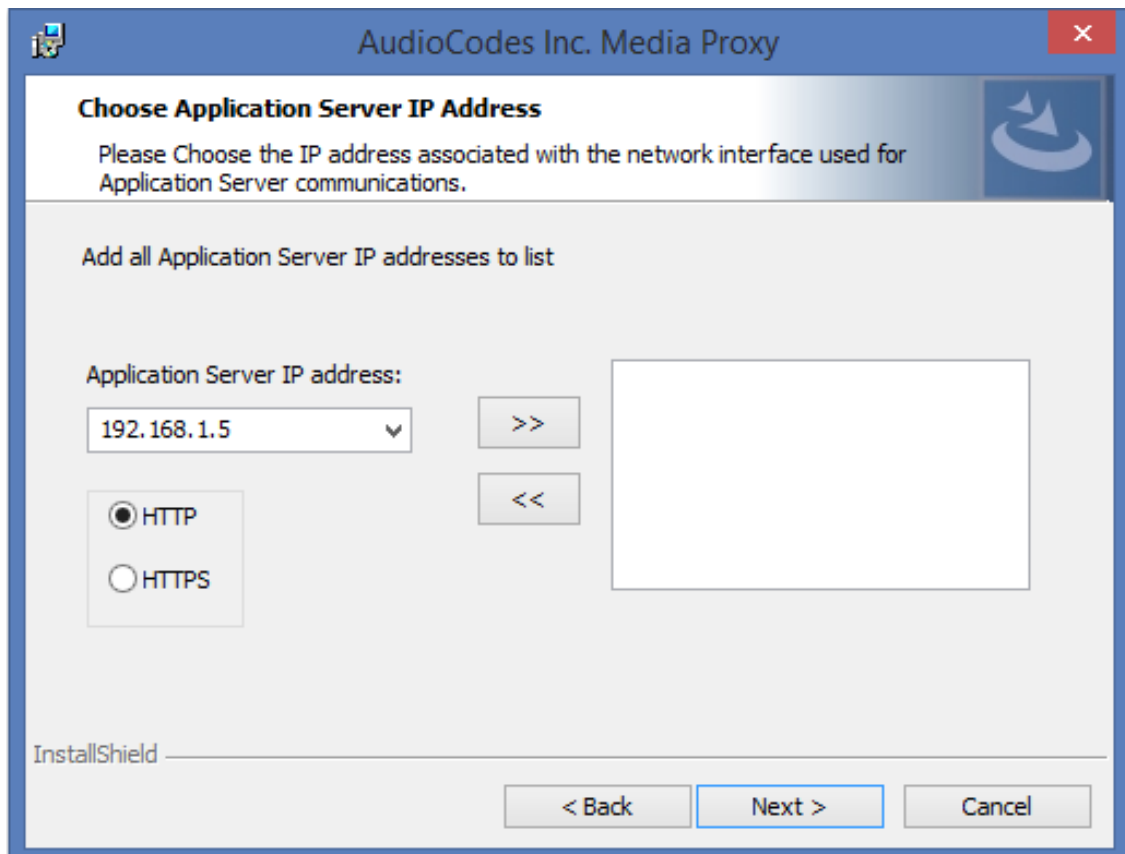


Figure 8-52: Choose Media Proxy IP Address



3. Enter the external Media-Proxy local IP address i.e. do not enter the IP address of the local host, and click Next.

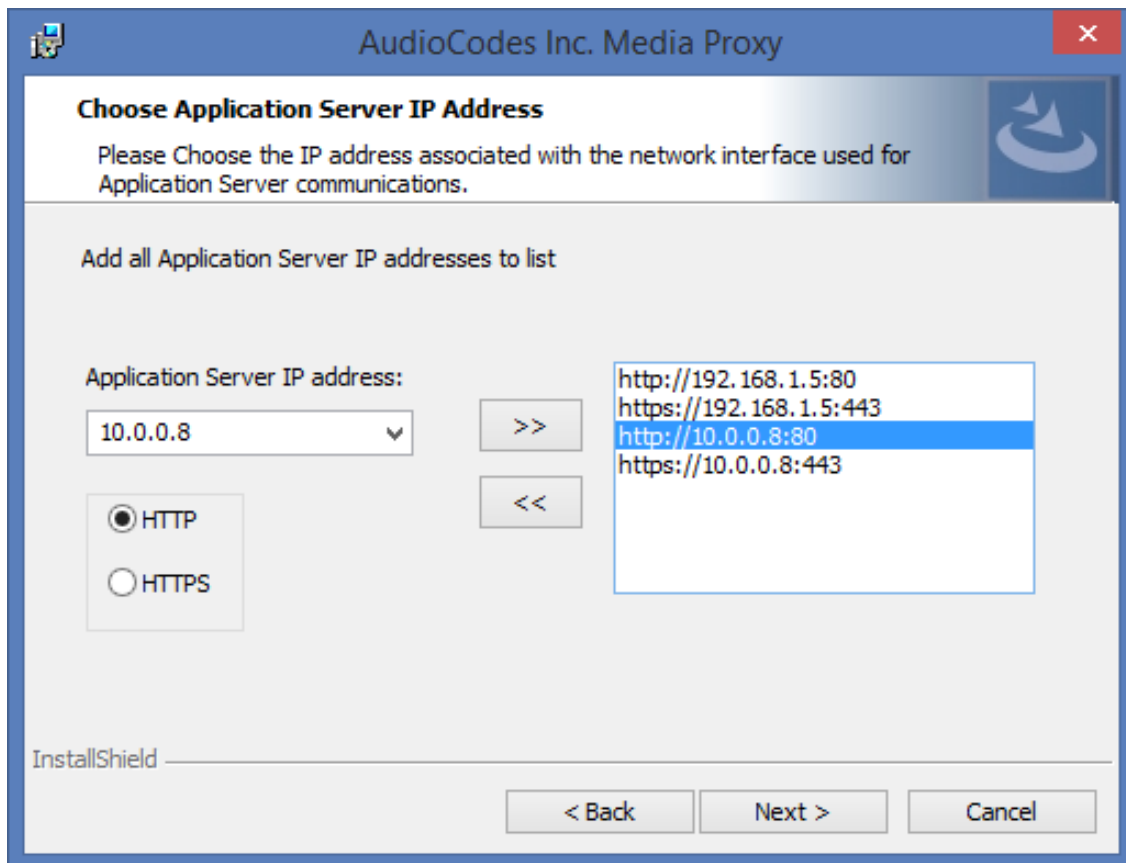
Figure 8-53: Choose Application Server IP Address



4. Configure the external Application Server IP address . Click >> to add the IP address to the list of Application Servers. Use the << button to remove an entry from the list. Click the entry that you wish to remove. At least one entry should be configured. Click Next to proceed.

An example configuration is shown in the figure below:

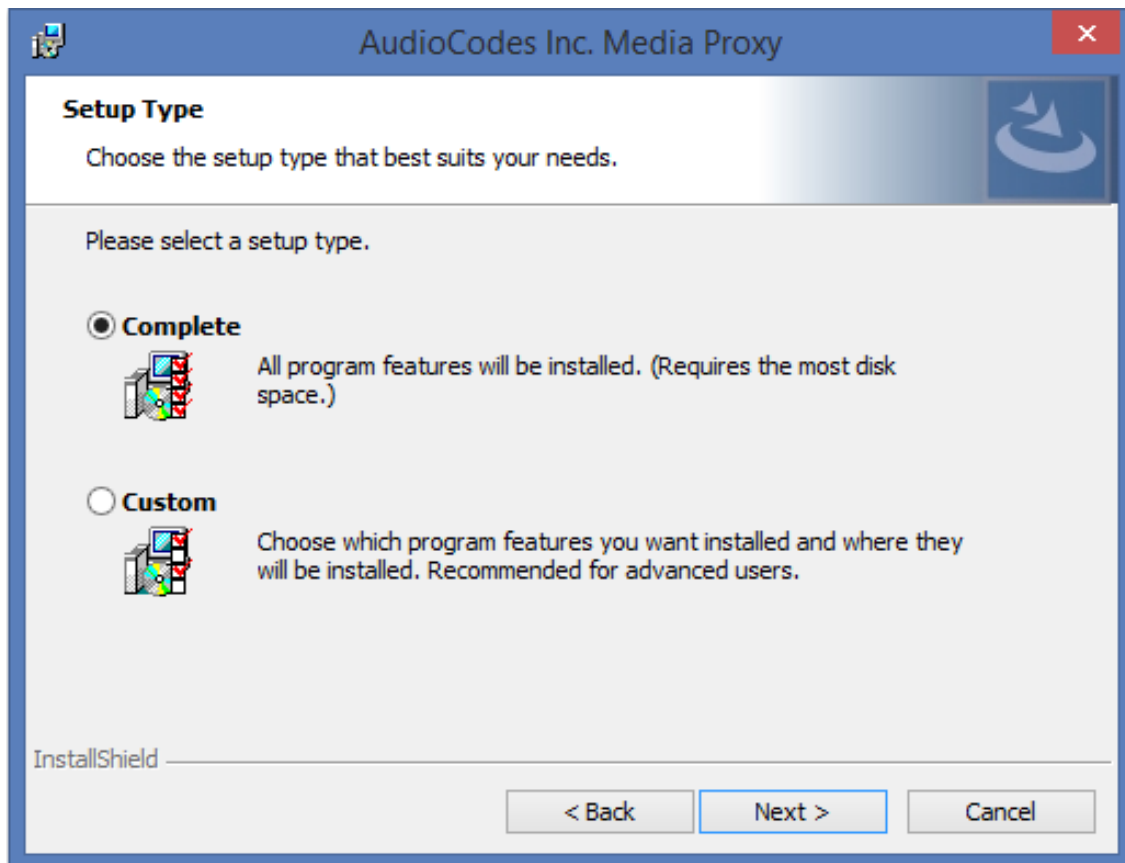
Figure 8-54: Choose Application Server IP Address



5. When you have completed the configuration, click Next to proceed.

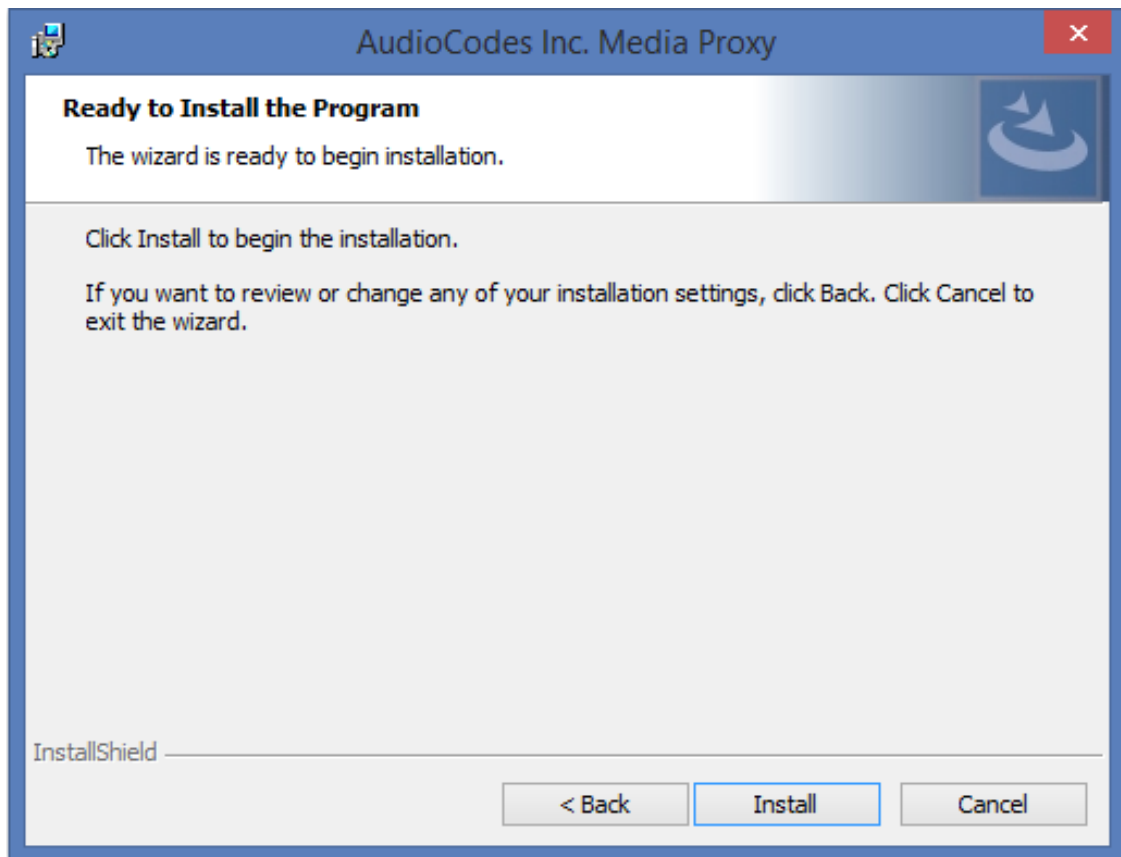
If you are performing an upgrade, the following screen may not be displayed.

Figure 8-55: Media Proxy Setup Type



6. Choose one of the following setup types and click Next:
  - Complete: Install to the default location: C:\Program Files\AudioCodes\SmartTAP\MP
  - Custom: Change the destination location.

Figure 8-56: Media Proxy Install



7. Click **Install**.

## Modifying Media Proxy Server Parameters

This section describes how to modify Media Proxy parameters after installation.

### ➤ To modify Media Proxy parameters:

1. Edit the System.config file at Program Files\AudioCodes\SmartTAP\MP\Config\.
2. If there is more than one interface in this machine, the Media Proxy server will use this interface.

```
<System  
key: localInterfaceAddress = "<local IP address>"  
  
>
```

Where "="<local IP address>" refers to the IP address of the IP interface when the installed machine has multiple IP interfaces.

3. Add option asList = "< Application Server Web Address>" to specify the list of Application servers for the Media Server.

```
<System
key: asList = "http://172.26.144.23:80, "http://172.26.144.24:80"/>
<System
key: asList = "https://172.26.144.23:443, "https://172.26.144.24:443"/>
```

Where < list of Application Server IP Web addresses>contains a comma separated list of the Application servers for the Media Proxy server in the SmartTAP Active/Active Configuration.

- (Optional) Modify the following Beep tone parameters (see table below for details):

```
<System beepEnabled="true" beepDurationMs="1000" voiceGain="1"
beepGaindBm="15"intervalDurationSeconds="15"/>
```



Beep tones can also be enabled to play in the Recording Profile in SmartTAP 360° Live Web interface.

**Table 8-1: Beep Tone Parameters**

Parameter	Description	Default
beepEnabled	Set true to play beep during calls. Default : true	beepEnabled
beepDurationMs	Beep duration in milliseconds, valid range [1-30000].	1000
voiceGain	0 – voice is removed, 1 – voice is added to tone as is, valid range [0-1].	1
beepGaindBm	Beep gain in -dBm units. range [3-31] (-3dBm to -31dBm), 3-Loudest, 31-Quietest	15
intervalDurationSeconds	Interval between each beep.	15

- Restart Media Proxy Service.

## Installing Media Delivery Server for Skype for Business

The Media Delivery is used specifically in Microsoft Skype for Business environment. The SmartTAP CD-IP will instruct the MD running on the Skype for Business Mediation, Conference or Edge server to capture a copy of the SRTP “voice” call that is traversing the Skype for Business server and send the copied SRTP “voice” to the SmartTAP server for long-term storage.



- The Media Delivery is only required for deployments that involve Microsoft Skype for Business when utilizing the Edge, Mediation or Conference server to capture the SRTP.
- It is highly recommended to configure the Firewall with the required ports to ensure proper communication prior to the software installation. See [Firewall Configuration](#) on page 59.

➤ **To Install Media Delivery (Skype for Business only):**

1. Run the Install.bat from the SmartTAP "Suite\" folder.
2. Select the Distributed software Custom Setup type.
3. Click AudioCodes Inc. Media Delivery Server.
4. Click Install to continue.
5. Select Recording Type Monitoring or Edge.
6. Select Monitoring when utilizing the Mediation or Conference server.
  - Specify the physical NIC interfaces to monitor. In a NIC teaming environment do not select the virtual NIC.
7. Select Edge when utilizing the Edge server.
  - Specify the Edge Internal & External NIC interface to monitor. Select the physical NIC interfaces.
8. Select Complete, click **Next** to continue.
9. Click **Install**.
10. Click **Finish** to complete installation.

## Installing Announcement Server

The Announcement Server (AN) is used specifically in the Microsoft Skype for Business environment as a call recording announcement service to let PSTN callers know their call will be recorded.

The SmartTAP 360° Live Skype for Business plugin on the FE will redirect the inbound PSTN calls to the targeted to be recorded users to the AN to play the announcement. Once the announcement is played, the call will be redirected to the original destination.

If you need to setup a group of Announcement Servers for redundancy or scalability, make sure to execute the following steps on each Announcement Server.

Do the following:

1. Announcement Server Preparation: Install Core Components & Local Replica Configuration Store
2. [Announcement Server Software Installation Procedure](#) on page 122

### 3. [Announcement Server-Post Installation Procedures](#) on page 127



Before proceeding, ensure that you have noted the installation requirements (see [Before Installing Microsoft Skype for Business Components](#) on page 73).

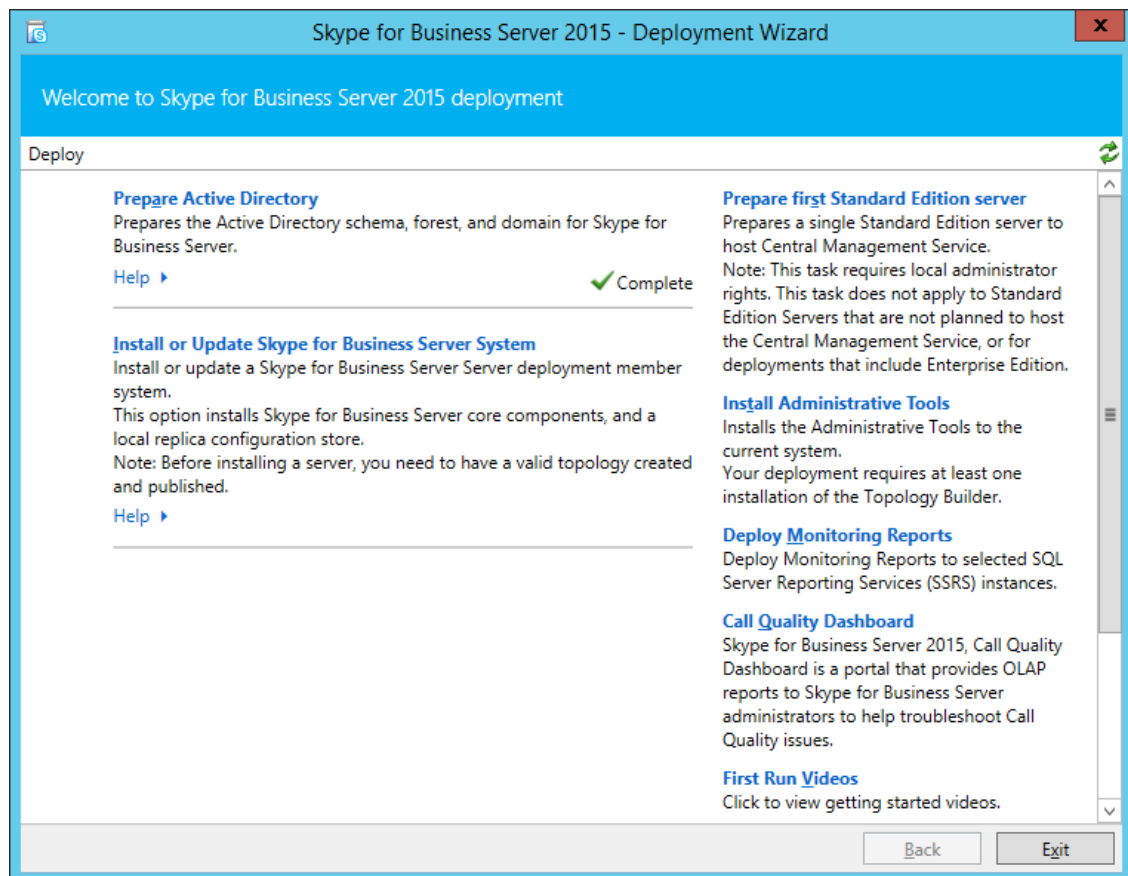
## Announcement Server Preinstall of Core Components and Local Replica Configuration Store

This section describes the installation of the Core components & Local Replica Configuration store using the Deployment wizard as a prerequisite for installation of the Announcement Server.

### ➤ To install the Deployment wizard:

1. Start the Skype for Business Server 2015 Deployment Wizard.

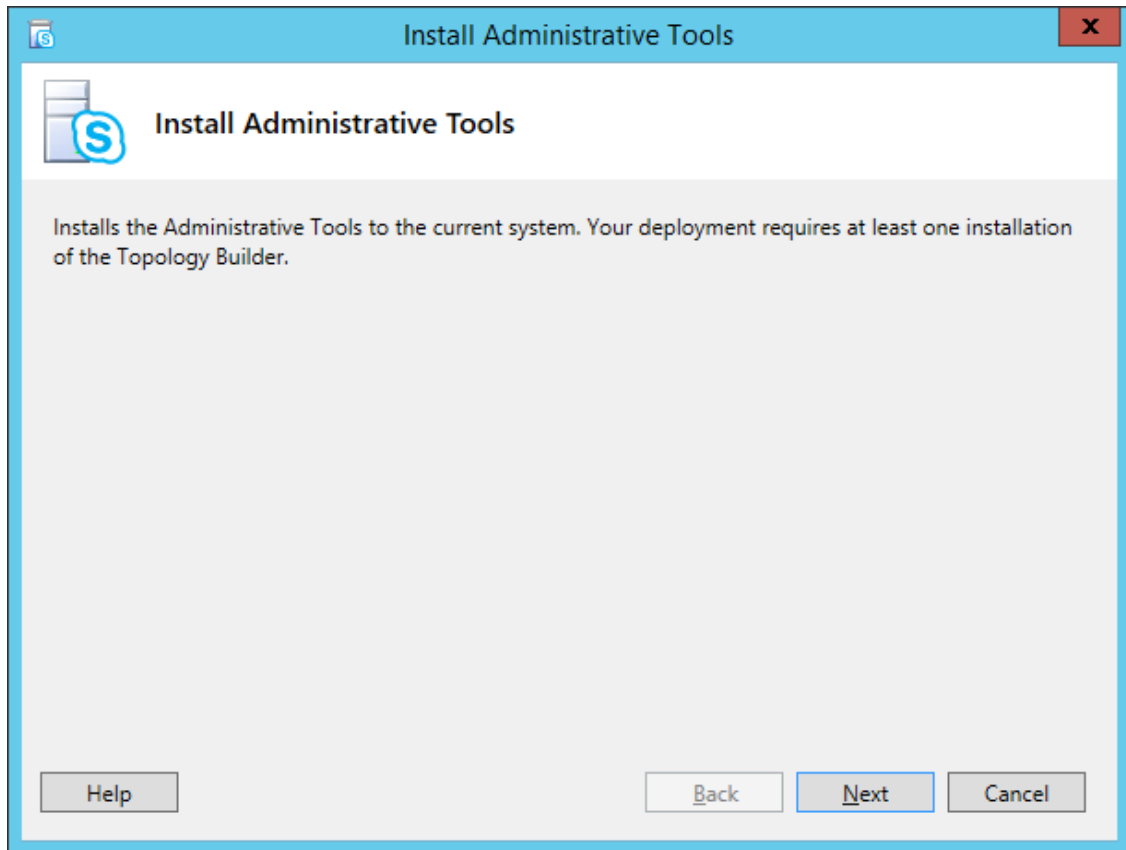
**Figure 8-57: Skype for Business Server 2015 – Deploy**



2. Select **Install Administrative Tools** and click **Next**.



Figure 8-58: Install Administrative Tools



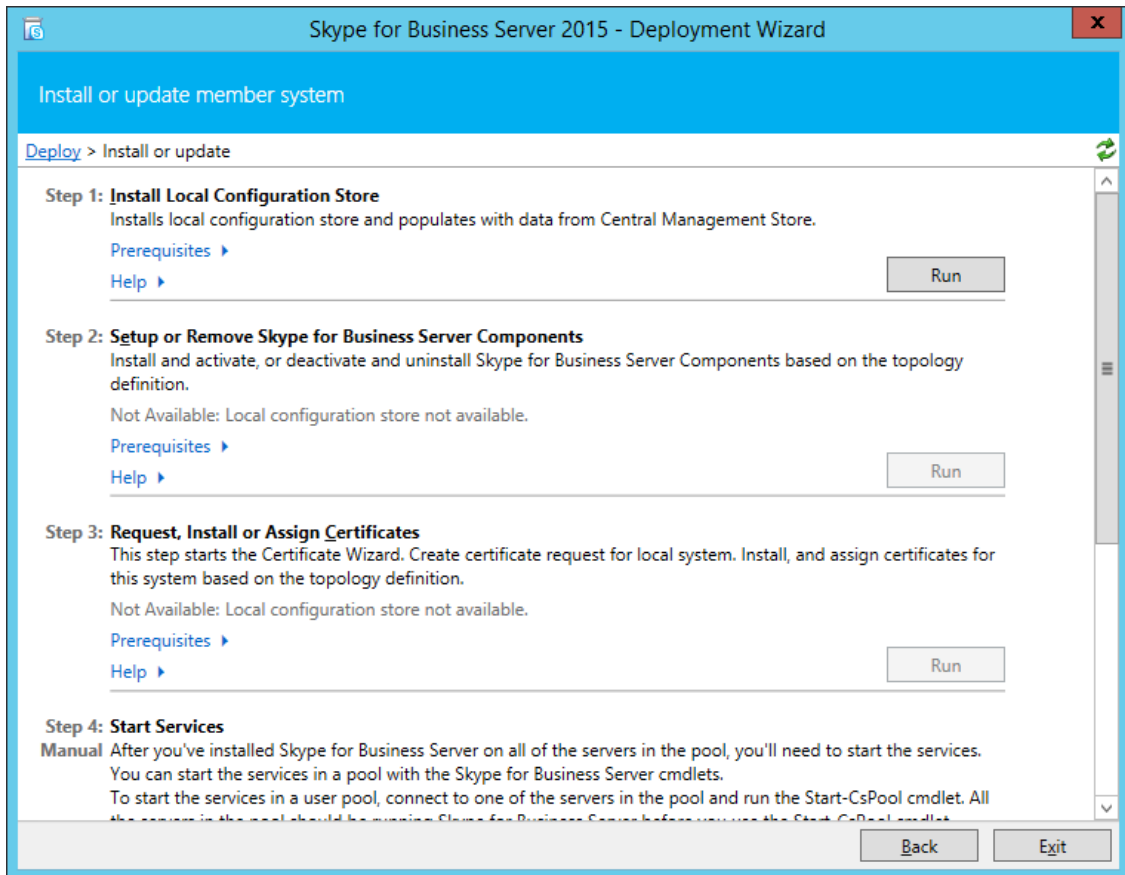
When completed, the following is displayed:

Figure 8-59: Install Status

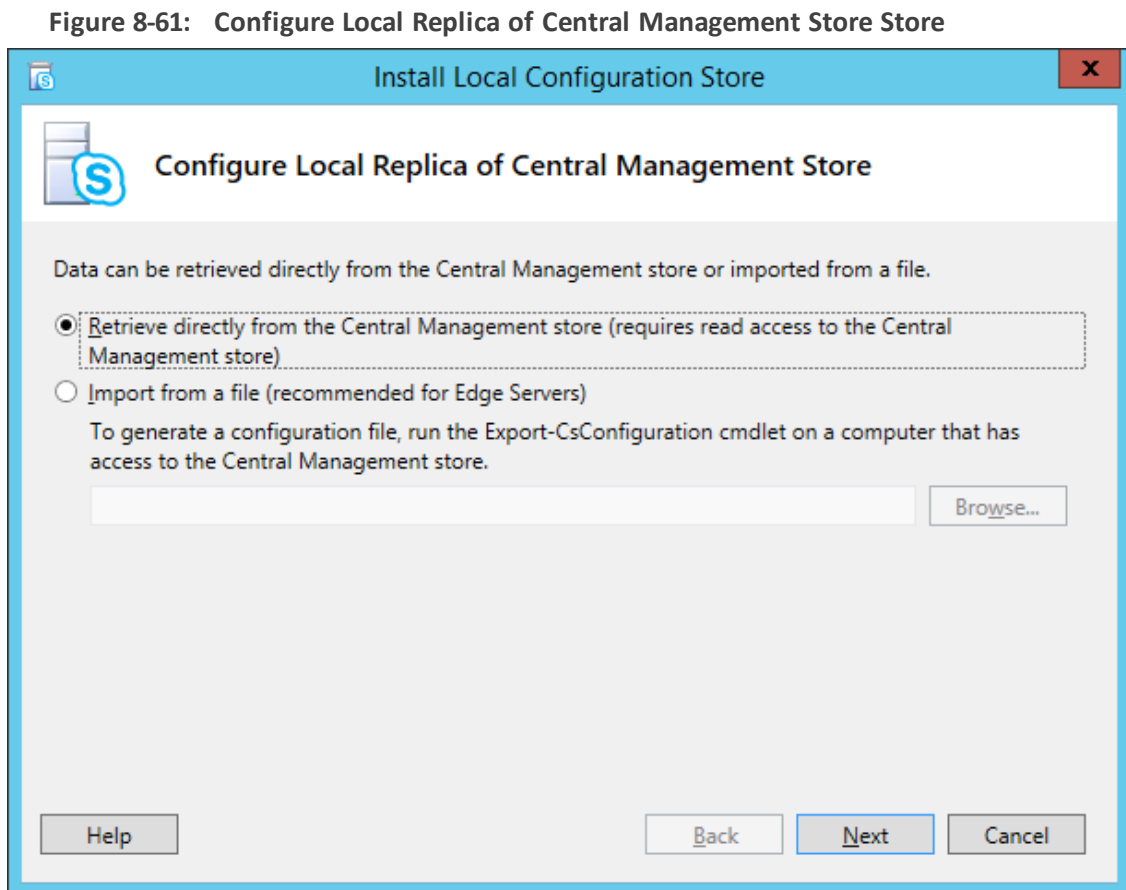
**Install Administrative Tools** ✓  
Installs the Administrative Tools to the current system.  
Your deployment requires at least one installation of the Topology Builder.

3. Click **Next** to continue.

Figure 8-60: Install Local Configuration Store



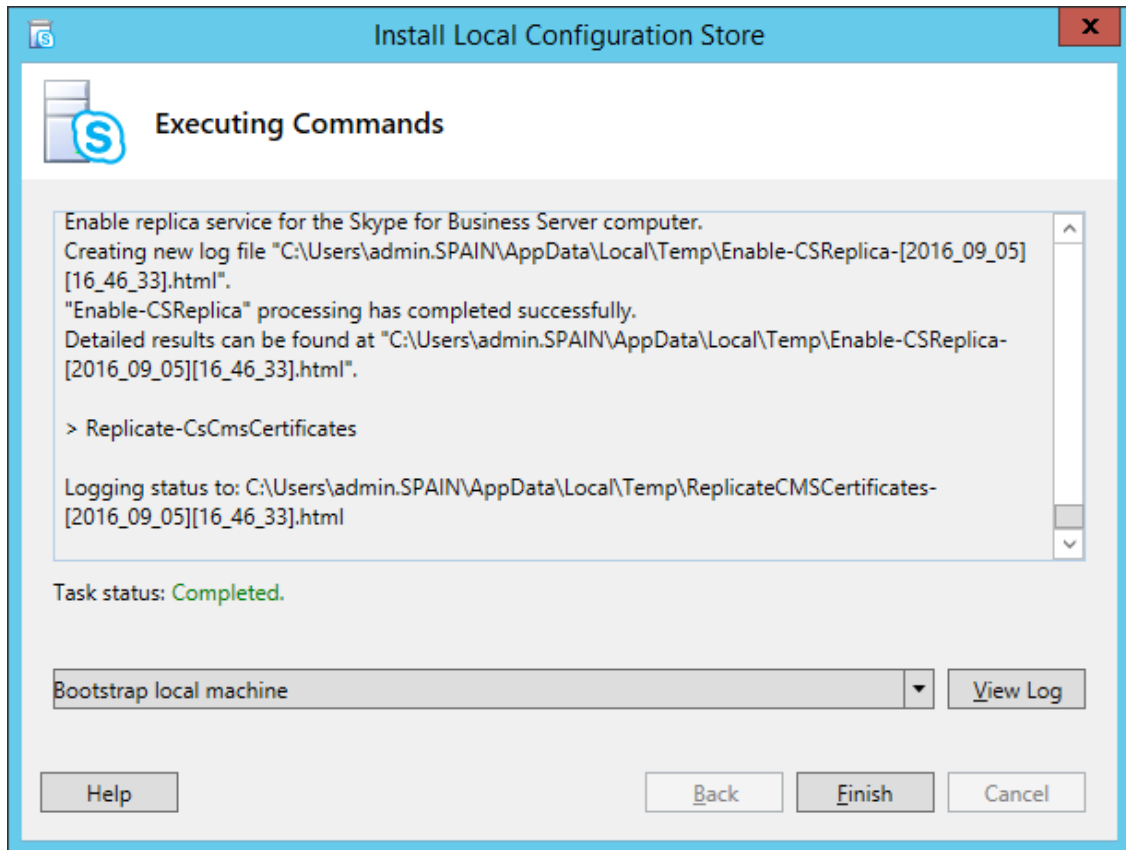
4. Choose option **Step 1: Install Local Configuration Store** and click **Run**.  
Installs core components & local replica configuration store.



5. Click **Next** to continue.

Once completed, a screen similar to the following is displayed:

Figure 8-62: Executing Commands



6. Click **Finish**.

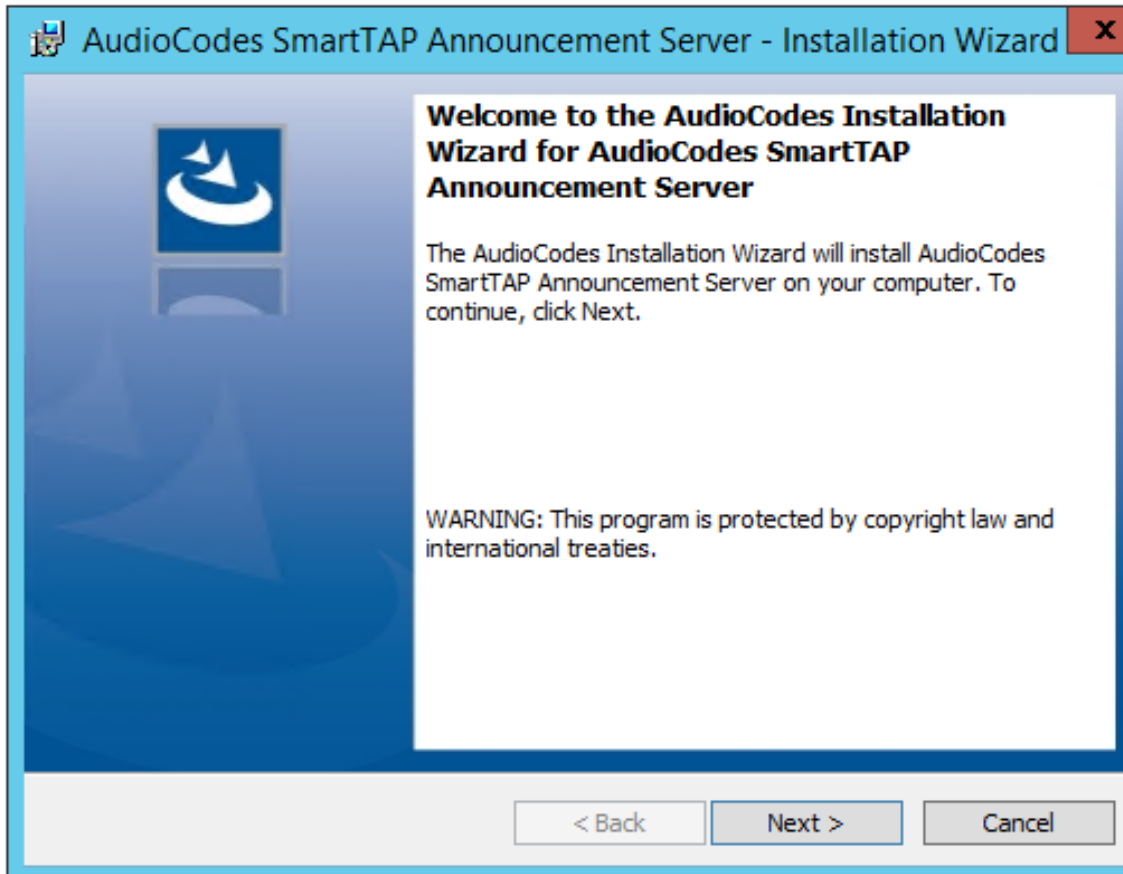
## Announcement Server Software Installation Procedure

This section describes the installation of the Announcement server using the wizard.

### ➤ To install the announcement server using the wizard:

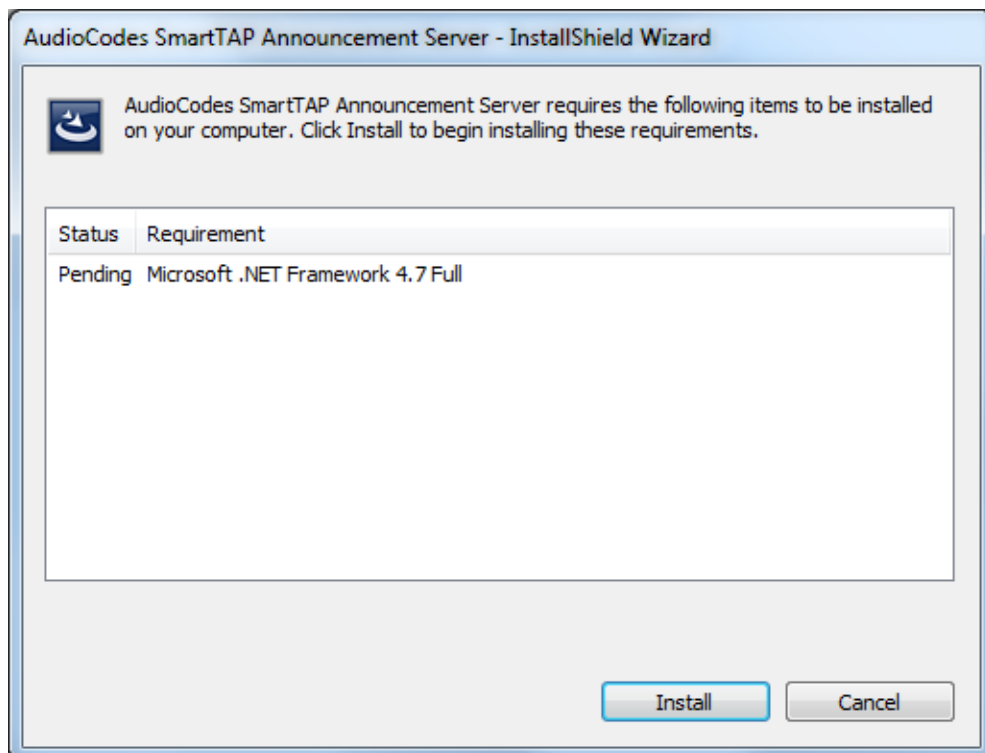
1. Launch the Installation wizard.

Figure 8-63: Announcement Server Installation Wizard



The following screen may appear if the .NET Framework 4.7 is not installed.

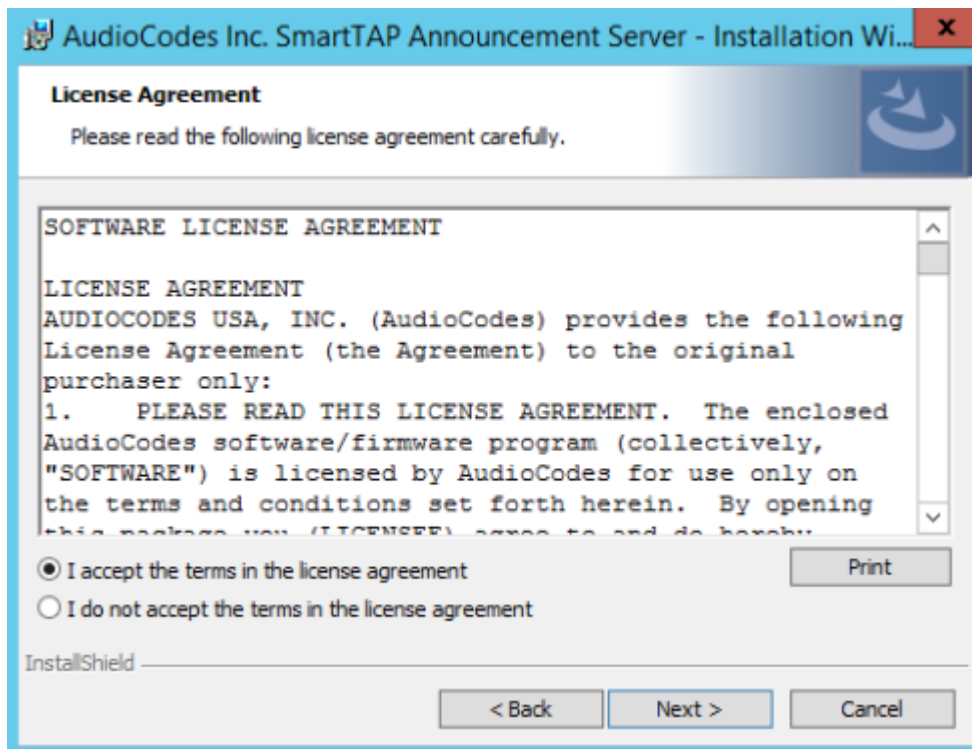
2. Click **Install** to continue.



3. Click **Next**.

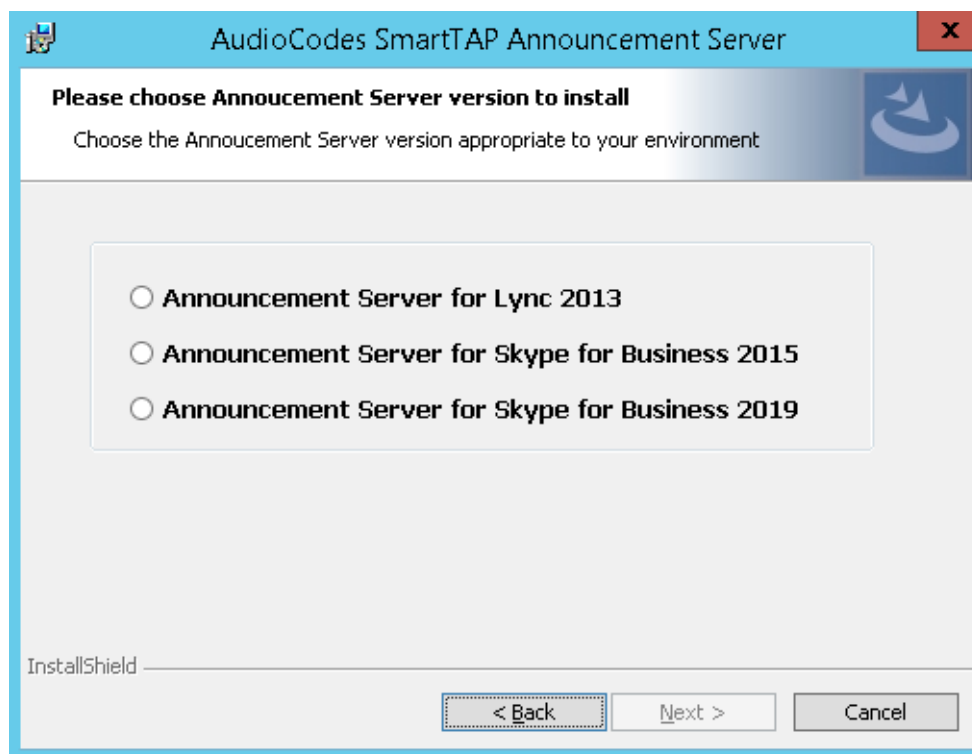
If you are installing from a Suite, then the following screen may not be displayed.

Figure 8-64: License Agreement



4. Click **Next** to agree to the license.

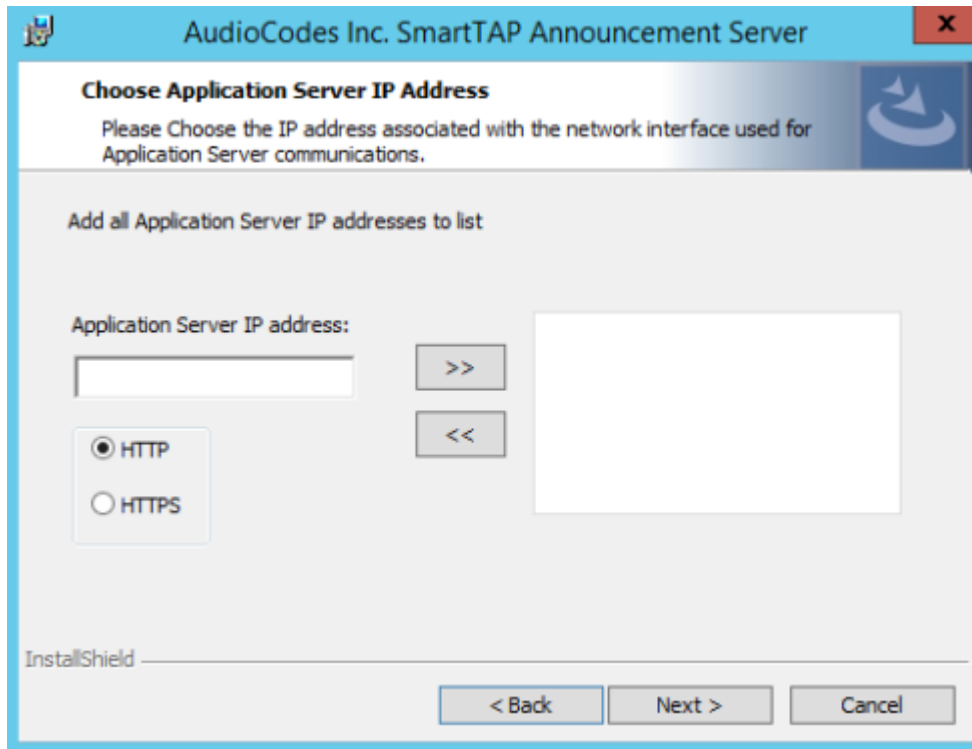
Figure 8-65: Announcement Server



5. Select the type of Announcement server and click **Next**:

- Announcement Server for Lync 2013
- Announcement Server for Skype for Business 2015
- Announcement Server for Skype for Business 2019

**Figure 8-66: Choose Application Server IP Address**



6. Configure external Application Server IP address and select either the HTTP or HTTPS protocol. Click >> to add the IP address to the list of Application Servers. Use the << button to remove an entry from the list. Click the entry that you wish to move. At least one entry should be configured. An example configuration is shown in the figure below.

Figure 8-67: Application Server IP Address

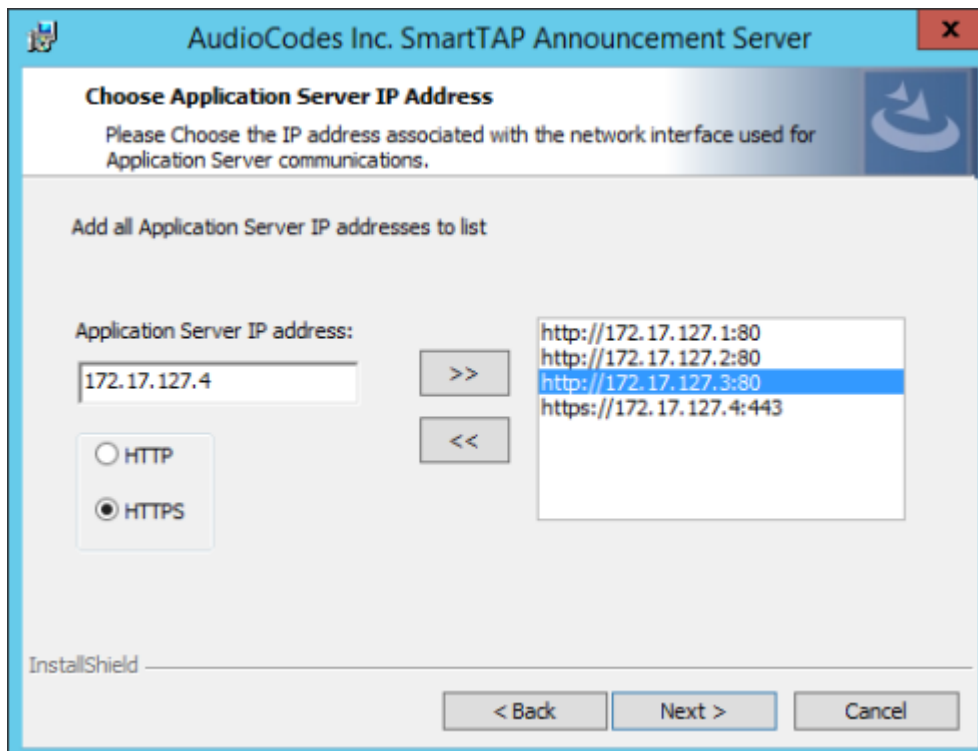
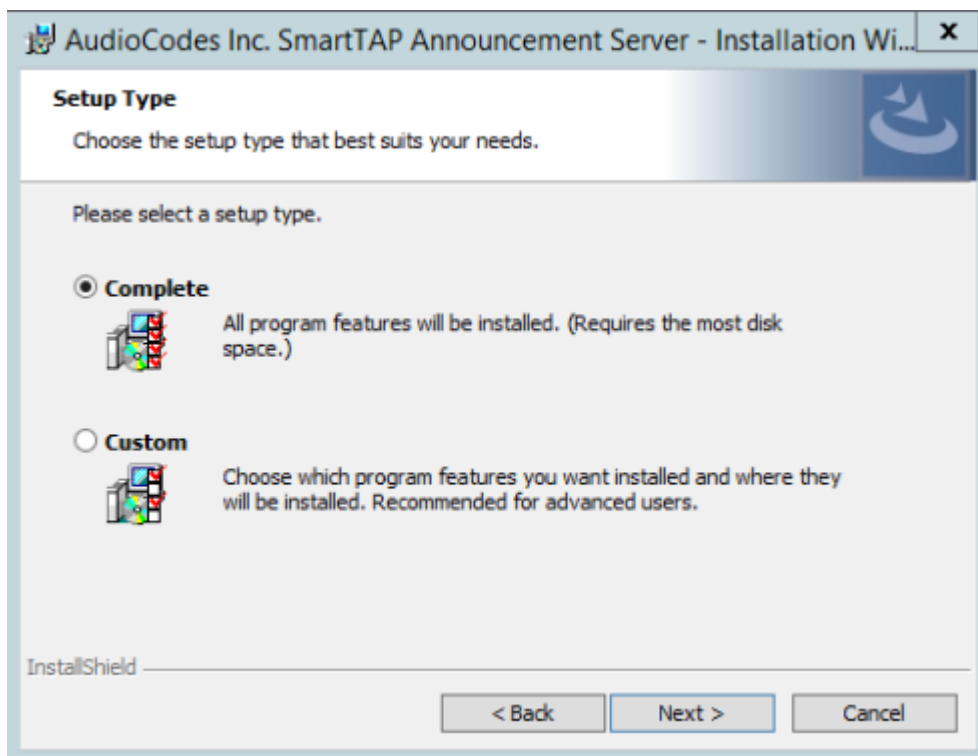


Figure 8-68: Setup Type



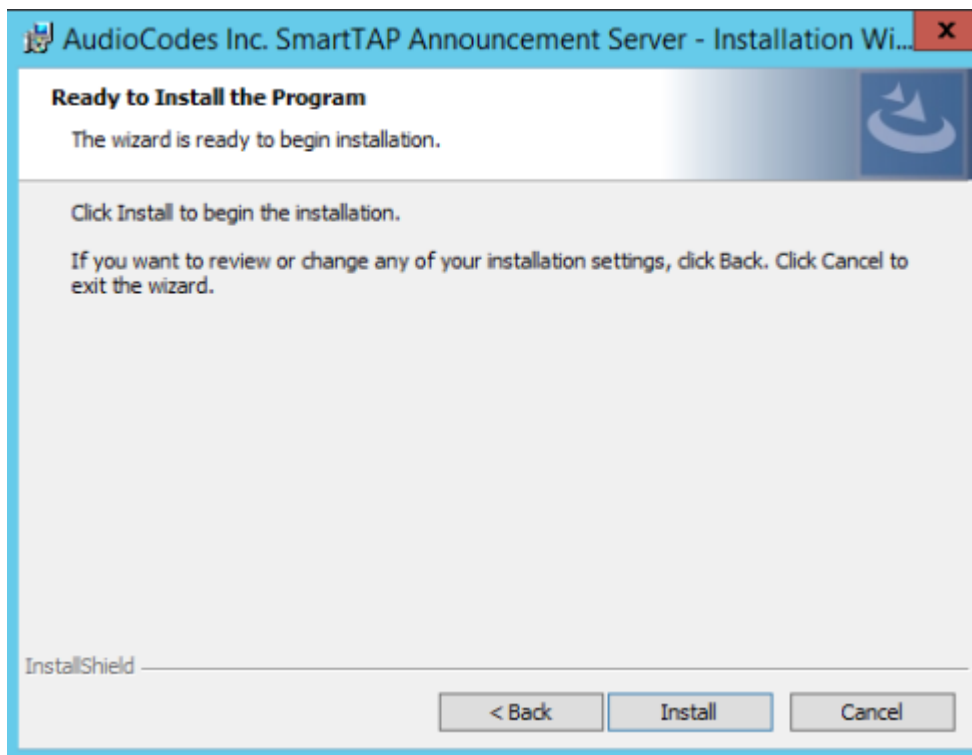
7. Choose the Setup Type and click **Next**:
  - Complete: Install to the default location: C:\Program Files\AudioCodes\SmartTAP\ANN
  - Custom: Change the destination location.





If you are performing an upgrade, this screen may not be displayed.

Figure 8-69: Install Commences



8. Click **Install** to commence the installation process.



- Do not install on the SmartTAP server.
- The Announcement Service will not start automatically. It needs to be started manually after configuring the Announcement Services (see below).

## Announcement Server-Post Installation Procedures

This section describes the following procedures required following the installation of the Announcement server:

- [Step 1-Activate Announcement Services](#) below
- [Step 2-Add Announcement Servers to DNS](#) on the next page
- [Step 3-Configuring Announcement Server \(Skype for Business\)](#) on the next page

### Step 1-Activate Announcement Services

This section describes how to configure Announcement Services.

#### ➤ To activate announcement services:

1. Start the PowerShell console as an Administrator user with the following permissions:

- The user must be a member of RTCUniversalServerAdmins for creating the trusted-application.
- In addition, for creating a certificate to use by AN service, the account must be a local administrator and have rights to the specified certification authority.



The CA is sometimes configured to not allow creating certificates online, and in that case, the activation will always fail regardless of the account. In this case it is required to create and assign a certificate using the Skype for Business deployment wizard and re-run the activation script. The activation script will detect an installed certificate and continue execution.

2. Change the working folder to the PowerShell folder in the Announcement Server installation folder: SmartTAP 360° Live\AN\PowerShell\.
3. Run the `.\Activate.ps1` command.
4. Enter port 12171 when prompted.
5. Save the AnnouncementsApp application endpoint name. It should be logged in the PowerShell command line window as shown in red color below:
6. “...AnnouncementsApp application endpoint name sip:NAME@domain.com...”
7. Save the NAME string and use it in the “Steps to add Announcement Servers to DNS” section.
8. Start AudioCodes Announcement Service.

## Step 2-Add Announcement Servers to DNS

### ➤ To Add Announcement Servers to DNS

- Add DNS ‘A’ record to the appropriate zone on the configured DNS server per Announcement server against the AnnouncementApp name that was saved in “Steps to activate Announcement Services” section (NAME, example: AnnouncementsApp-pool-2013-1, AnnouncementsApp-pool-2015-1).

## Step 3-Configuring Announcement Server (Skype for Business)

This section describes how to setup the Announcement server for recording announcements and attaching audio files.

### ➤ To configure the Announcement server:

1. Copy all ANN files and IVR files that you wish to configure for Announcements to the following location:

Program Files\AudioCodes\SmartTAP\AN\Config\StateMachineConfig

Figure 8-70: StateMachineConfig File Location

Name	Date modified	Type	Size
Config	9/7/2016 3:04 PM	File folder	
Languages	9/7/2016 3:04 PM	File folder	
MusicOnHold	9/7/2016 3:04 PM	File folder	
PowerShell	9/7/2016 3:04 PM	File folder	
Repo	9/7/2016 3:04 PM	File folder	
StateMachineConfig	9/7/2016 3:04 PM	File folder	



This action enables you to attach ANN and IVR files to the Recording Profile in the SmartTAP 360° Live Web interface.

All ANN files must be saved in the WMA format and all IVR files must be saved in JSON format. For configuration of recording profiles, Refer to the *SmartTAP 360° Live Administrators Guide*.

2. Edit the System.config file from the following location:  
Program Files\AudioCodes\SmartTAP\AN\Config\.
3. Add option 'normalizeNumbers="true"' when normalization of called numbers for the Announcement Server is required.

```
<System
normalizeNumbers ="true"
/>
```

4. Add option asList ="< Application Server Web address>" to specify the Web address of the Application server (AS) for the Announcement server.

```
<System
key: asList ="<Application Server IP address>"
/>
```

5. Restart AN Service.

## Installing SmartTAP Monitoring Service

SmartTAP Monitoring Service(STMonitoringSvc) is designed to test SmartTAP recording functionality using AudioCodes HealthMonitor (HM) and Microsoft UCMA. It will generate a test call between two trusted application endpoints and will update the results to the Health Monitor . The Health Monitor will then validate the recording metadata and the call media and send an alarm or email to SmartTAP if required. For more information on the Health Monitor, refer to the *SmartTAP Administrator Guide*.



- The CA is sometimes configured to not allow creating certificates online, and in this case, the activation will always fail regardless of the account and users are required to create and assign a certificate using the Skype for Business deployment wizard and re-run the activation script. The activation script will detect an installed certificate and continue execution.
- One additional Target and Recorder license is required for the test endpoints.

➤ **Do the following:**

1. Install the SmartTAP Monitoring Service ([SmartTAP 360° Live Monitoring Service Installation Procedure](#) below)
2. Activate the SmartTAP Monitoring Service ([Activating the SmartTAP 360° Live Monitoring Service](#) on the next page)
3. Configure the SmartTAP Monitoring Service ([Configuring the SmartTAP Monitoring Service](#) on page 132)

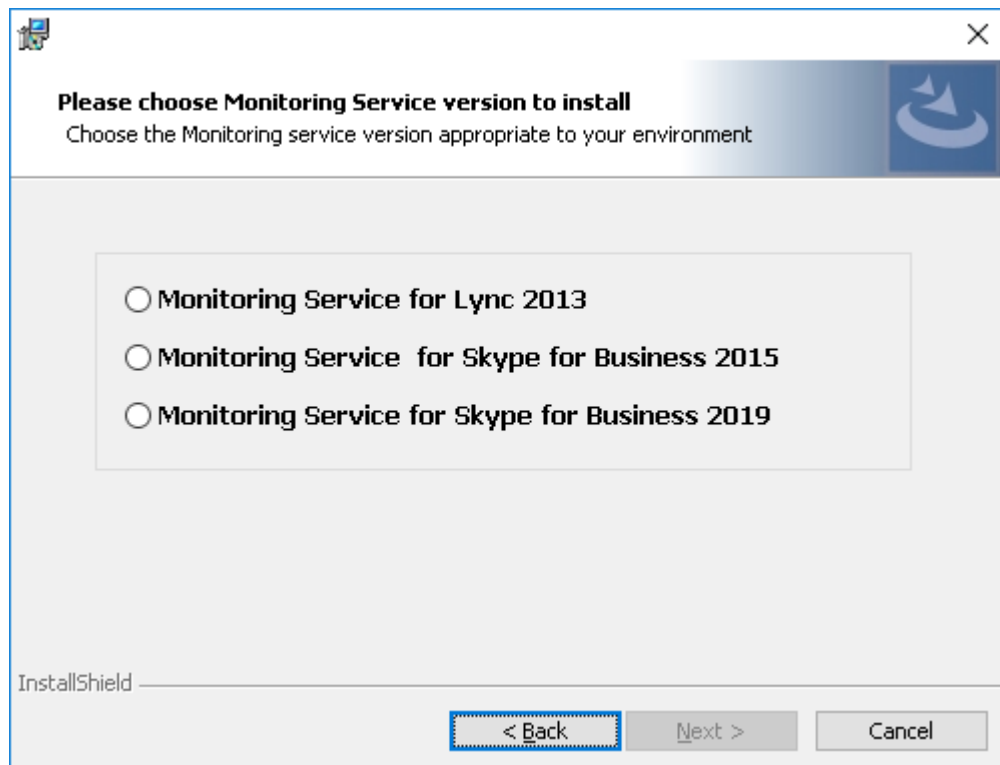
## SmartTAP 360° Live Monitoring Service Installation Procedure

This section describes the SmartTAP 360° Live Monitoring Service Installation procedure.

➤ **To install the SmartTAP 360° Live Monitoring service:**

1. "SmartTAP 360° Live Monitoring Service" can be installed using SmartTAP 360° Live Installation Suite or dedicated installer inside Suite folder (Suite\Monitoring Service\SmartTapMonitoringService Setup.exe).
2. Choose **Accept** and continue with **Next**.

Figure 8-71: Monitoring Service Skype for Business Platform



3. Select the Lync/Skype for Business platform that you wish to install.
4. Specify the machine's IP address where the Health Monitor is installed.  
It is possible to choose from the drop-down menu or write manually.



If the Health monitor is configured to localhost, then enter the Health Monitor IP address..

5. Choose complete for installation on a default drive or custom to change it.
6. Click **Next**.

The installation folder is found at the following path:

<rootDrive>:\Program Files\AUDIOCODES\Tools\SmartTapMonitoringService

## Activating the SmartTAP 360° Live Monitoring Service

This section describes how to activate the SmartTAP 360° Live Monitoring Service.

### ➤ To activate SmartTapMonitoringService service:

1. Start the PowerShell console as an Administrator user with the following permissions:
  - The user must be a member of RTCUniversalServerAdmins for creating the trusted-application.

- In addition, for creating a certificate to be used by SmartTapMonitoringService, the account must be a local administrator with rights to the specified certification authority.
2. Change the working folder to the PowerShell folder in the SmartTapMonitoringService installation folder.
  3. Run the `.\Activate.ps1` command.
  4. Enter custom port when prompted (ex. 10145).
  5. Save the SmartTapMonitoringService application endpoint names – caller and agent. It should be logged in the PowerShell command line window as below:

```
“...application endpoint name sip:SmartTapTestCallGeneratorAgent@domain...”  
“...application endpoint name sip:SmartTapTestCallGeneratorCaller@domain...”
```

6. Save the Trusted application name, ex.:  
“Creating SmartTapTestCallGenerator trusted application on SmartTapTestCallGenerator-pool-2015-1”
7. Add DNS ‘A’ record of saved in previous step to the appropriate zone on the configured DNS server.

```
example: SmartTapTestCallGenerator-pool-2015-1.
```

8. Start the service.

## Configuring the SmartTAP Monitoring Service

This section describes how to configure the SmartTAP Monitoring Service. The configuration file is found in `<STMonitoringSvc root>\Config\System.config`. The SmartTAP Monitoring service retrieves its configuration from the HealthMonitor (REST), therefore the Health Monitor's IP address is required. If this IP address was not configured in installation, it can be configured as follows:

```
<System  
healthMonitoringRestServerBaseUrl="http://localhost:10101/"  
>
```

All the configuration default values are remarked in the System.config, for example:

```
key: restClientKeepAliveInterval
```

Default Value: 30

Description: Time in seconds for Rest client to send keep alive message.

```
key: callerMediaFilePath
```

```
Default Value: "Music\callerMusic.wma"
```

```
Description: caller media file path.
```

```
key: agentMediaFilePath
```

```
Default Value: "Music\agentMusic.wma"
```

```
Description: agent media file path.
```

In addition, these parameters can be added to the 'System' section if they need to be overwritten:

```
<System
```

```
  callerMediaFilePath ="Music\OtherCallerFile.wma"
  agentMediaFilePath ="Music\OtherAgentFile.wma"
  restClientKeepAliveInterval="40"
/>
```

#### UcmaMonitoringConfig section Example

```
<UcmaMonitoringConfig>
```

```
  <IsActivationMode>true</IsActivationMode>
  <Endpoints/>
  <ActionTimes> 15:30,15:40</ActionTimes>
  <KeepAliveTimeoutSec>60</KeepAliveTimeoutSec> -> NEW Field.
```

```
</UcmaMonitoringConfig>
```

In case the caller is created by the above script sip:S-martTapTestCallGeneratorCaller@anw365.lab , and the Agent is sip:S-martTapTestCallGeneratorAgent@anw365.lab ,

The test call scenario is a Basic call wherethe Caller calls the Agent and the Agent answers automatically. Both partiesplay 'callerMediaFilePath'\agentMediaFilePath' media files accordingly, with default values of 'Music\callerMusic.wma' and 'Music\agentMusic.wma'.

STMonitoringSvc informs the Health Monitor when the call is has ended, and the Health Monitor validates that the call has been recorded.

In case the call was not recorded or recorded with silent media, the Health Monitor sends an alarm to the ApplicationServer and will notify by email to the list of recipients configured in <smtpProperties> section.

- The above users must be targeted users in the SmartTAP system (one additional target and recorder license should be available for this purpose)).
- Also Call retention policy for one day is required in order not to overload the Database.

### ActionTimes

ActionTimes configures the time of the day to generate the test call (generated daily).

```
<ActionTimes>15:30, 15:40, 15:50</ActionTimes>
```

### KeepAliveTimeoutSec

A Keep Alive mechanism between the Health Monitor and STMonitoringSvc was added to the Health Monitor. If you already have installed the Health Monitor, add the <Keep-AliveTimeoutSec> field under the <UcmaMonitoringConfig> section as is shown in the example below. This field is for the purpose of maintaining communication between the STMonitoringSvc and the Health Monitor. The KeepAliveTimeoutSec configures the time in seconds that the Health Monitor receives a Keep-alive message from STMonitoringSvc. If this time is exceeded, the Health Monitor sends a Communication Down alarm.

```
<KeepAliveTimeoutSec>60</KeepAliveTimeoutSec>
```



## 9 Integration Configuration

SmartTAP supports several telephony integration options. Go to the appropriate integration to configure Call Delivery for your environment:

- Microsoft Skype for Business - See Section [Microsoft Skype for Business Deployment](#) on page 70
- SIPRec – See [SIP Recording \(SIPRec\)](#) on page 151
- Voip Mirror Port (SIP, H.323, Avaya, Cisco, etc.) – see [VoIP Port Mirroring](#) below
- Analog Trunk, Station & Radio – see [Analog Trunk / Radio](#) on page 142

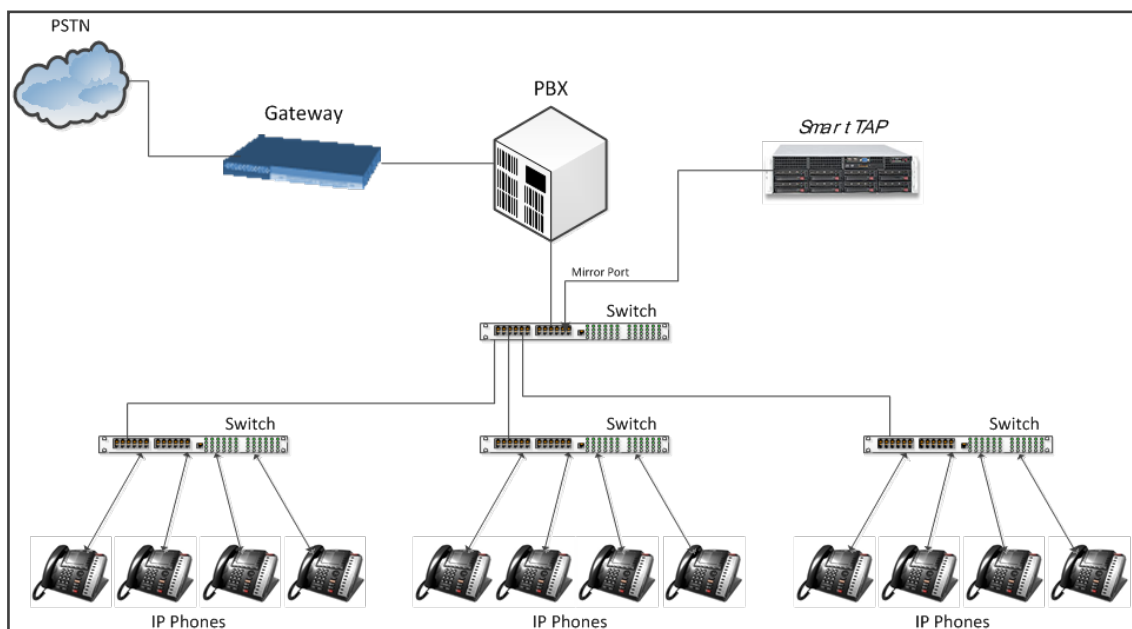
### VoIP Port Mirroring

The SmartTAP 360° Live software supports many different IP PBX station side-tapping configurations using a mirror port or network tap appliance to receive the unencrypted Signaling and RTP.

### Inbound / Outbound

This is the easiest configuration as seen in the following image because you can mirror the traffic at the highest-level switch before the PBX. Tapping between the PBX and the phone is crucial to determining the call Initiator and Recipient.

Figure 9-1: Inbound/Outbound

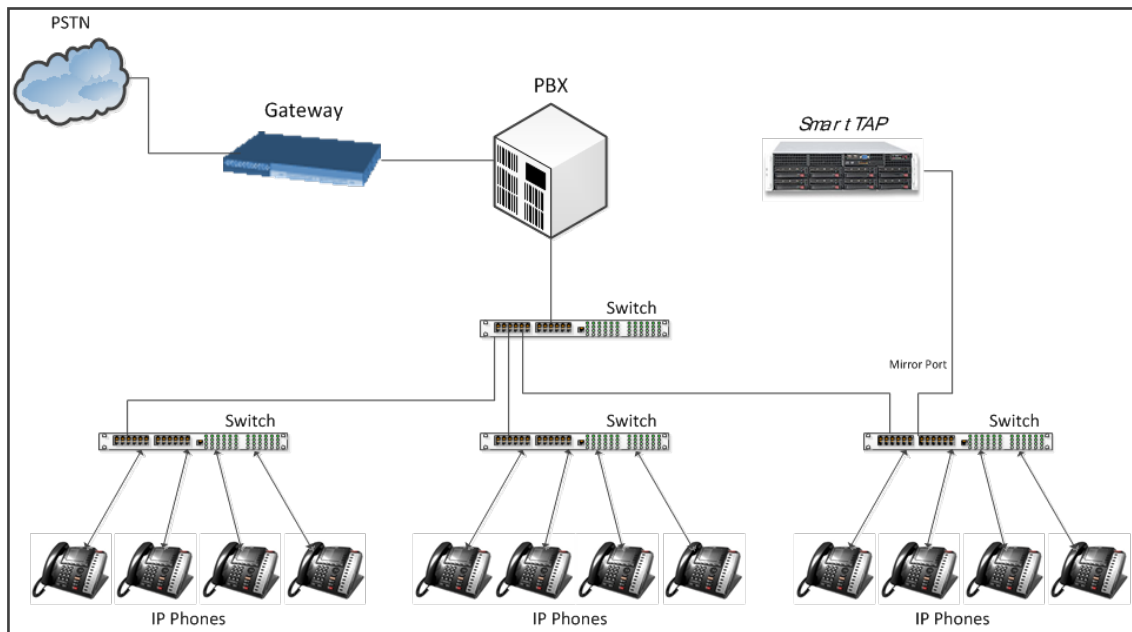


### Station to Station

To record station-to-station calls, it is important to understand that once the call is established between two endpoints that reside on the same switch, the RTP "Voice" will travel directly

between them. The recorder will miss the RTP, if you tap at the highest-level switch as in the diagram above. To avoid missing the RTP, mirror the traffic from the lower level switch with endpoints connected that need to be recorded.

**Figure 9-2: Station to Station**



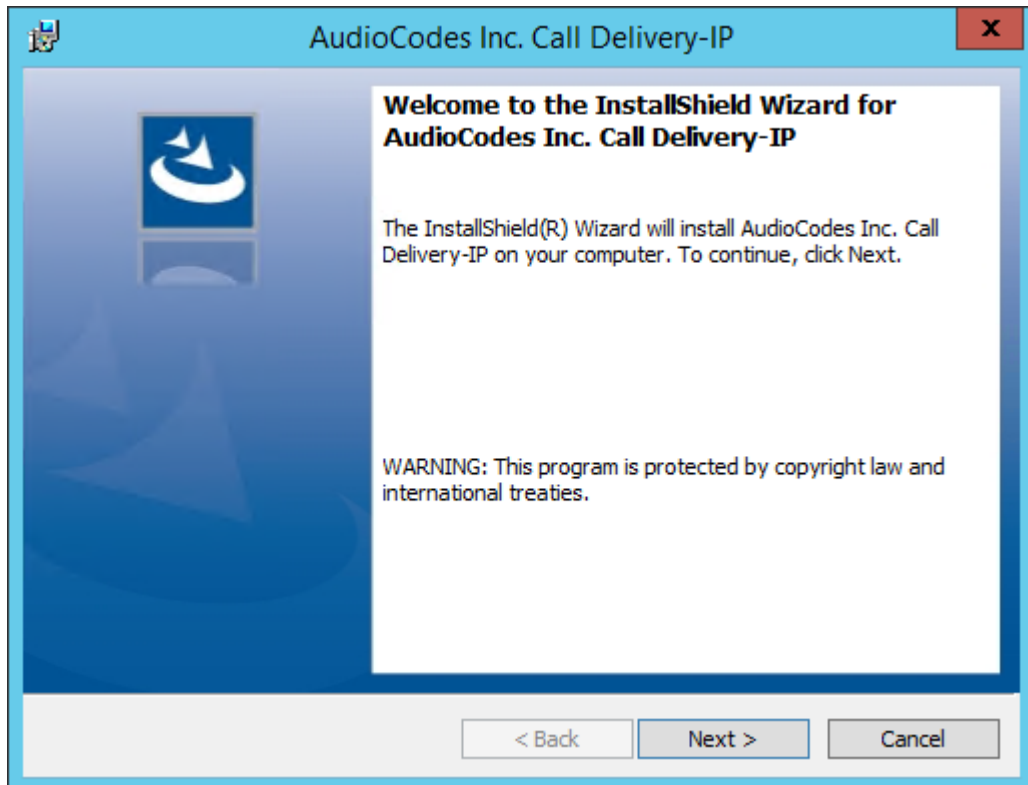
## Call Delivery Install for VoIP (Port Mirror)

This section describes how to install Call Delivery Install for VoIP (Port Mirror).

### ➤ To install Call Delivery Install for VoIP (Port Mirror)

1. Click **Next** to continue.

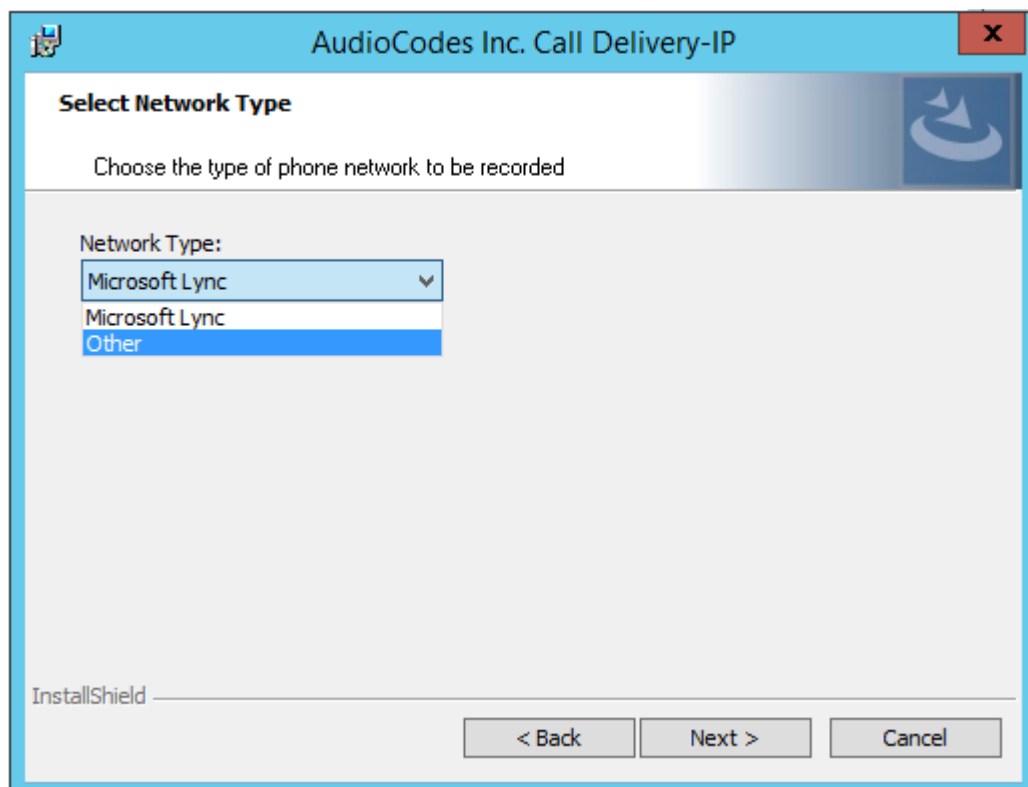
Figure 9-3: Call Delivery IP



Assuming you are NOT setting up for a Skype for Business installation, select "Other" when prompted for the network type.

2. Click **Next** on the Server IP Setup.

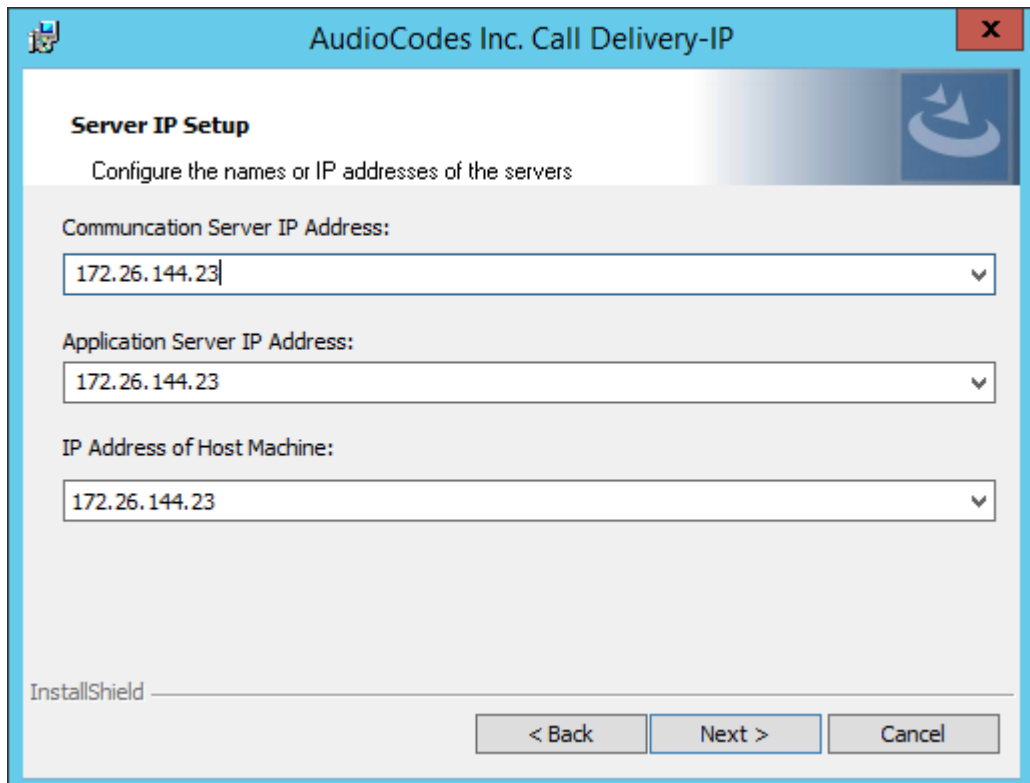
Figure 9-4: Select Network Type



Assuming the Call Delivery Service is on the same machine as the Application and Communication service leave the default below settings.

3. Click **Next** on the Server IP Setup.

Figure 9-5: Server IP Setup



**AudioCodes Inc. Call Delivery-IP**

**Server IP Setup**  
Configure the names or IP addresses of the servers

Communication Server IP Address:  
172.26.144.23

Application Server IP Address:  
172.26.144.23

IP Address of Host Machine:  
172.26.144.23

InstallShield

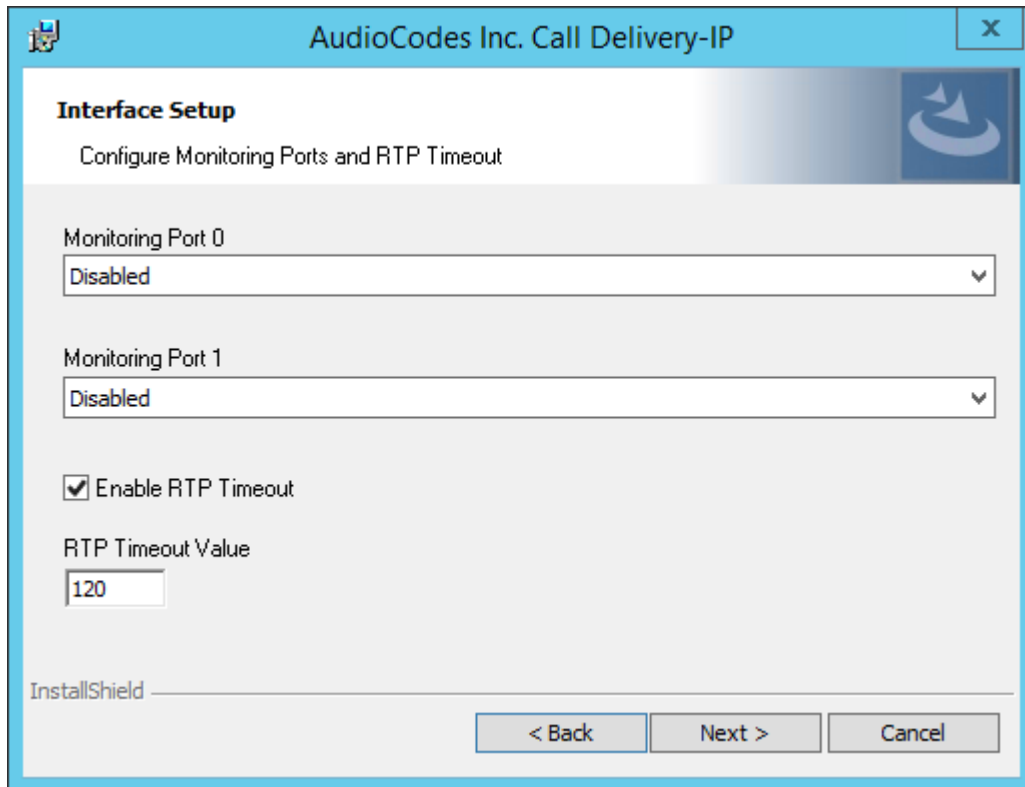
< Back    Next >    Cancel

SmartTAP passive IP integration supports monitoring up to 8 NIC interfaces. In a typical server, there are a minimum of two NIC interfaces. NIC 1 is used to connect the SmartTAP server to the LAN for user access. The 2<sup>nd</sup> NIC is connected to the mirror port on the switch to receive the signaling and RTP.

From the Monitoring Port 0 drop down list, select the appropriate NIC interface that is connected to the mirror port on the switch. Monitoring Port 1 is used in the event a 3<sup>rd</sup> NIC is required to connect to a different mirror port on a 2<sup>nd</sup> switch.

4. Select the appropriate Monitoring Port 0/1 interfaces from the dropdown menu in the Interface Setup screen

Figure 9-6: Interface Setup



5. Click **Next** on the Setup Type screen.
6. Click **Install** on the install screen.
7. Click **Finish** to finish.

### Additional Configuration for VoIP Port Mirroring

This section describes addition configuration for VoIP Port mirroring.

➤ **To perform additional configuration:**

1. Configure VoIP.cfg file to match IP PBX.
2. Configure mirror port on switch to mirror traffic to SmartTAP server.
3. Configure SmartWORKS Control Panel.

The following files located in the target path of the Call Delivery are the most common files that are required for the IP environment:

Default Path: ..... \AudioCodes\SmartTAP\CD-IP\Config\Voip.cfg

**Table 9-1: Description of the Avaya H.323 Specific Changes**

Field	Default	Description
Avaya_H323=[...]	N/A	Changes specific to Avaya H.323 recording. Uncomment section by removing hashes (#) at the beginning of each

Field	Default	Description
		line
H225CS	1720,TCP	H.323 Call Control port
H225RAS	1719,UDP	H.323 RAS port
SERVERIPS	N/A	IP address of Avaya PBX

VoIP.cfg changes for recording Avaya H.323 (unencrypted) are shown below:

```
#Avaya_H323 =
#[ H225CS=1720,TCP
# H225RAS=1719,UDP
# SERVERIPS=
# DCH=ON
# DCHFILTER=OFF
# CC=ON
# SUBTYPE=CM]
```

**Table 9-2: Description of the SIP Recording Specific Changes**

Field	Default	Description
SIP=[...]	N/A	Changes specific to SIP recording. Uncomment section by removing hashes (#) at the beginning of each line.
SERVERIPS	N/A	IP address of PBX, or list of IP addresses of PBXs (separated by comma).
TRANSPORT	UDP,5060	SIP signaling.
ADD_ TRANSPORTS	(optional field)	Additional transports such as (TCP,5060) when SIP uses TCP for signaling in addition to UDP.

Voip.cfg changes for recording SIP (unencrypted) are shown below:

```
SIP =
[
SERVERIPS=192.168.70.6,10.250.0.5,192.168.70.5
TRANSPORT=UDP,5060
ADD_TRANSPORTS=TCP,5060
CC=ON ]
]
```

## Setting Up Monitoring Interfaces

This section describes how to manually setup the monitoring interfaces.



SmartControl is no longer available for CD-IP.

### ➤ To setup the monitoring interfaces:

1. Run the System Profile Tool, C:\Program Files\AudioCodes\SmartTAP\tools\system\_profile.exe.

This tool generates a report file called report.txt. This file contains a list of network interfaces. Choose the interfaces you wish to monitor and then extract the respective GUIDs and interface names from the data provided in the report.

2. Open the C:\Program Files\AudioCodes\SmartTAP\tools\report.txt file and extract the GUIDs and interface names for those interfaces that you wish to monitor (example values are indicated in red in the extract below):

```
Fri Mar 31 13:19:31 2017: Details of network interfaces.
Fri Mar 31 13:19:31 2017: 0x0000000e:
Fri Mar 31 13:19:31 2017: Link encap:Ethernet
Fri Mar 31 13:19:31 2017: HWaddr 02:00:4c:4f:4f:50
Fri Mar 31 13:19:31 2017: name:\DEVICE\TCPIP_{65E31628-075A-4DEB-
A09E-C4041EC5F750}
Fri Mar 31 13:19:31 2017: MTU:1500 Speed:1215.75 Mbps
Fri Mar 31 13:19:31 2017: Admin status:UP Oper status:OPERATIONAL
Fri Mar 31 13:19:31 2017: RX packets:0 dropped:0 errors:0 unknown:0
Fri Mar 31 13:19:31 2017: TX packets:0 dropped:0 errors:0 txqueuelen:0
Fri Mar 31 13:19:31 2017: Descr: "Microsoft KM-TEST Loopback Adapter"
```

3. Edit the C:\Program Files (x86)\AudioCodes\SmartTAP\CD-IP\config\calldeliveryconfig.xml file:
  - a. Add the extracted GUID and interface name:

```
<monitoringInterfaces>
  <interface enabled="1" guid="{65E31628-075A-4DEB-A09E-
C4041EC5F750}" adapterName="Microsoft KM-TEST Loopback Adapter" />
</monitoringInterfaces>
```

- b. Set “enabled” to 1 for all those interfaces that you wish to monitor.

## Analog Trunk / Radio

The SmartTAP software supports analog loop start phone line trunk or station side and VOX activity based recording. The SmartWORKS LD card is designed for high impedance tapping.

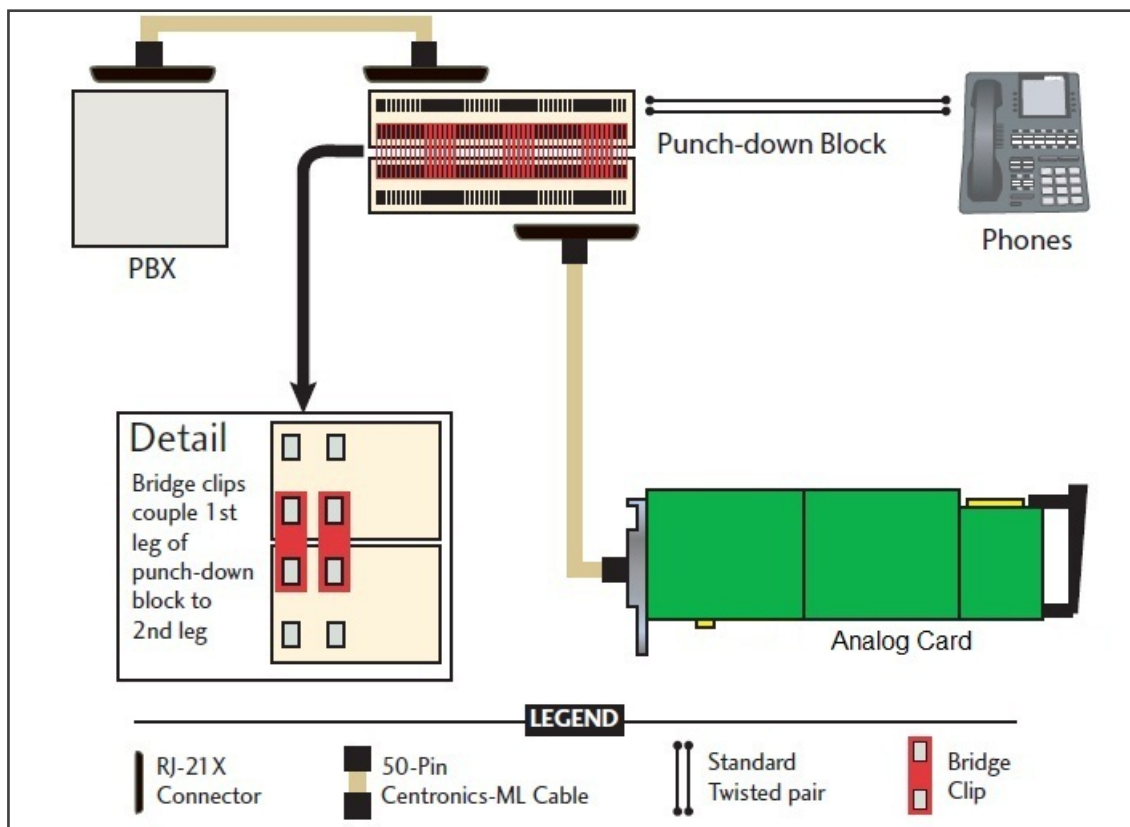
### Loop Start Trunk / Station

The battery voltage of the analog line may be different between Trunk and Station side. Adjusting SmartTAP to match the environment is easily achieved and discussed in the next chapter.

The 24-channel card is a Hi-Impedance tap card designed to passively tap the phone line. In the event of a card or server hardware failure, there will be no impact to normal operation of the phone or analog line.

The figure below represents a typical passive tap implementation using a 66 block. The maximum distance tested from PBX to Analog phone while tapping is 2200’.

**Figure 9-7: Passive Tap Implementation**



The image in Figure 1 represents the female connector on the Analog board. The pin-out follows industry standard wiring. The image in Figure 2 is typical color coded wiring used in 25 pair telco grade CAT 3 or higher cables.



Figure 9-8: Color-Coded Wiring-RJ21x Female Connector

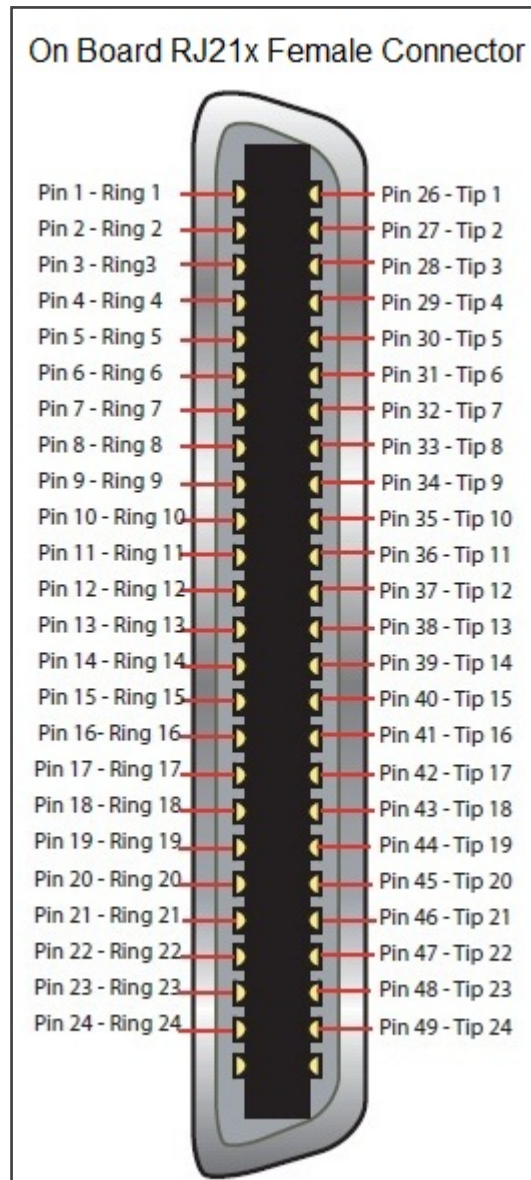
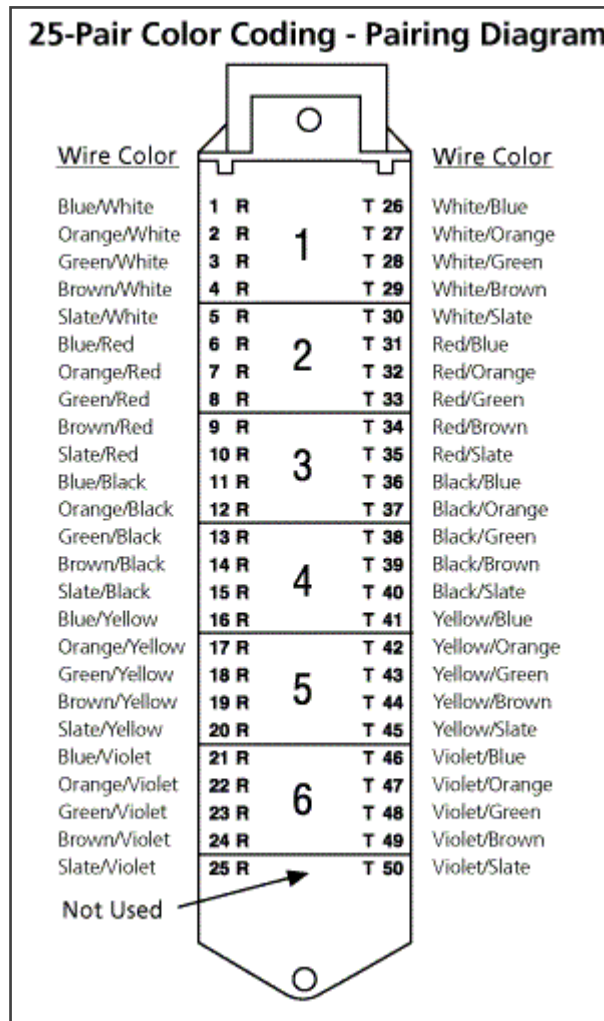


Figure 9-9: Color Coded Wiring-25-Pair Color Coding



### Call Delivery Install for Analog Recording (Passive Tap)

The Call Delivery Install for Analog Recording is executed when an LD card is detected on the server. The LD card records Analog phones.

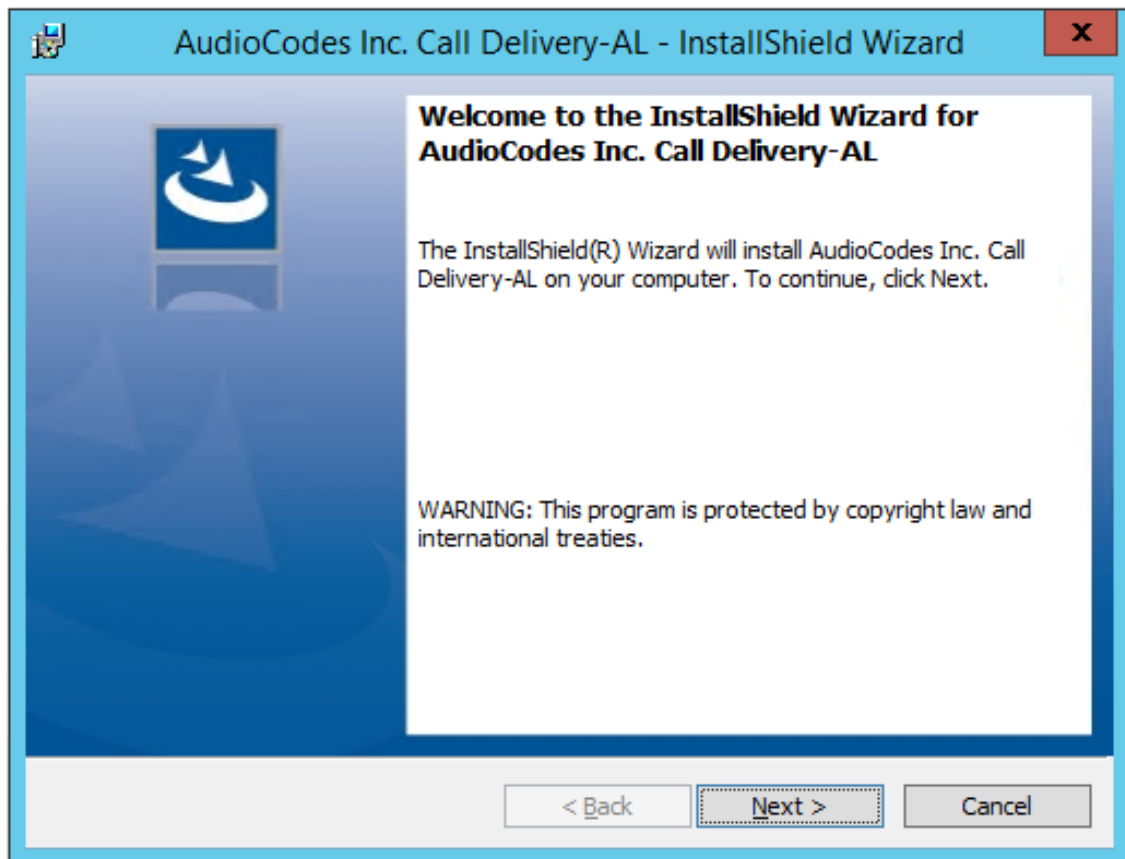


The screens shown in the procedure below are specific to the installation when a LD card is detected on the server.

➤ **To install Call Delivery for Analog Recording (Passive Tap):**

1. Click **Next** to continue on the Wizard for Call Delivery LD screen.

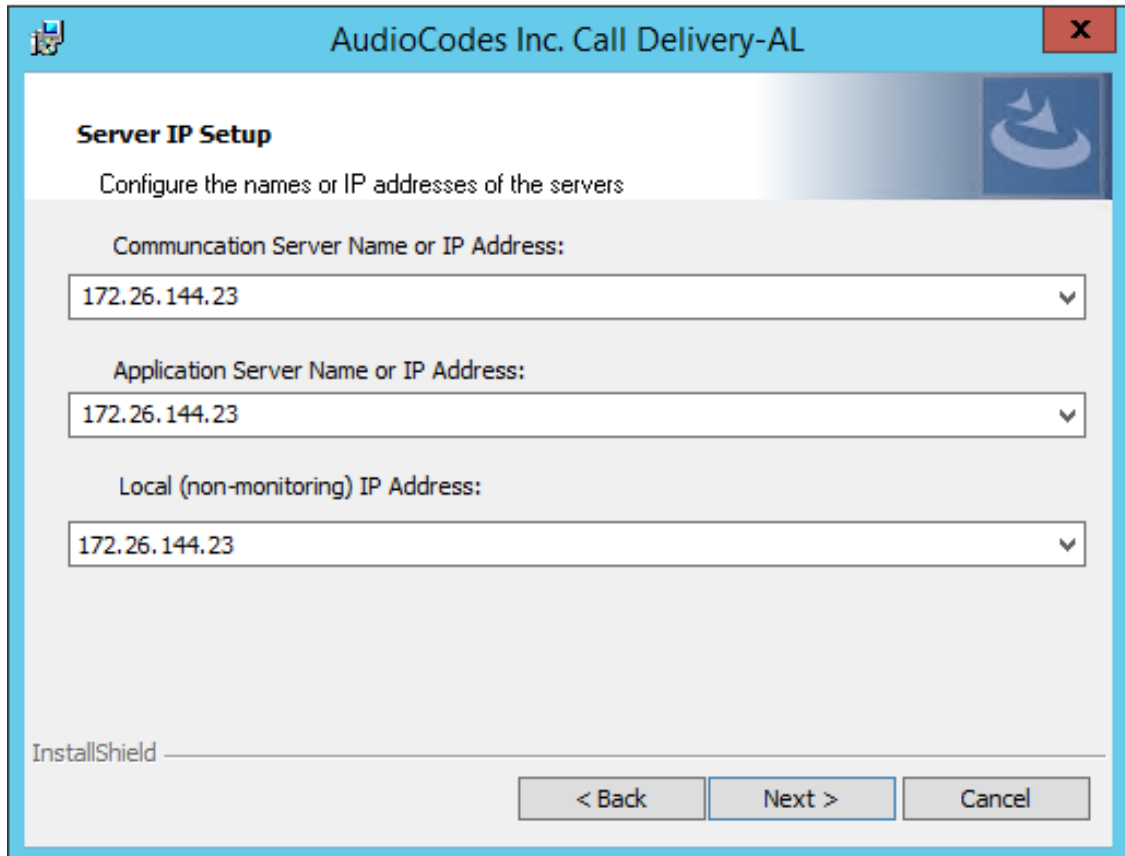
Figure 9-10: Call Delivery LD



In case of distributed or remote branch deployment, type in the real IP address of the Application Server (AS), Communication Server (CS), and the Local IP address machine (don't type in 127.0.0.1). In case of all-in-one deployment use the AS, CS, and the Local IP address parameters drop down list to choose the SmartTAP IP address.

2. Click **Next** on the Server IP Setup.

Figure 9-11: Server IP Setup



**AudioCodes Inc. Call Delivery-AL**

**Server IP Setup**

Configure the names or IP addresses of the servers

Communication Server Name or IP Address:  
172.26.144.23

Application Server Name or IP Address:  
172.26.144.23

Local (non-monitoring) IP Address:  
172.26.144.23

InstallShield

< Back    Next >    Cancel

3. Click **Next** on the Setup Type screen.
4. Click **Install** on the install screen.
5. Click **Finish** to finish.

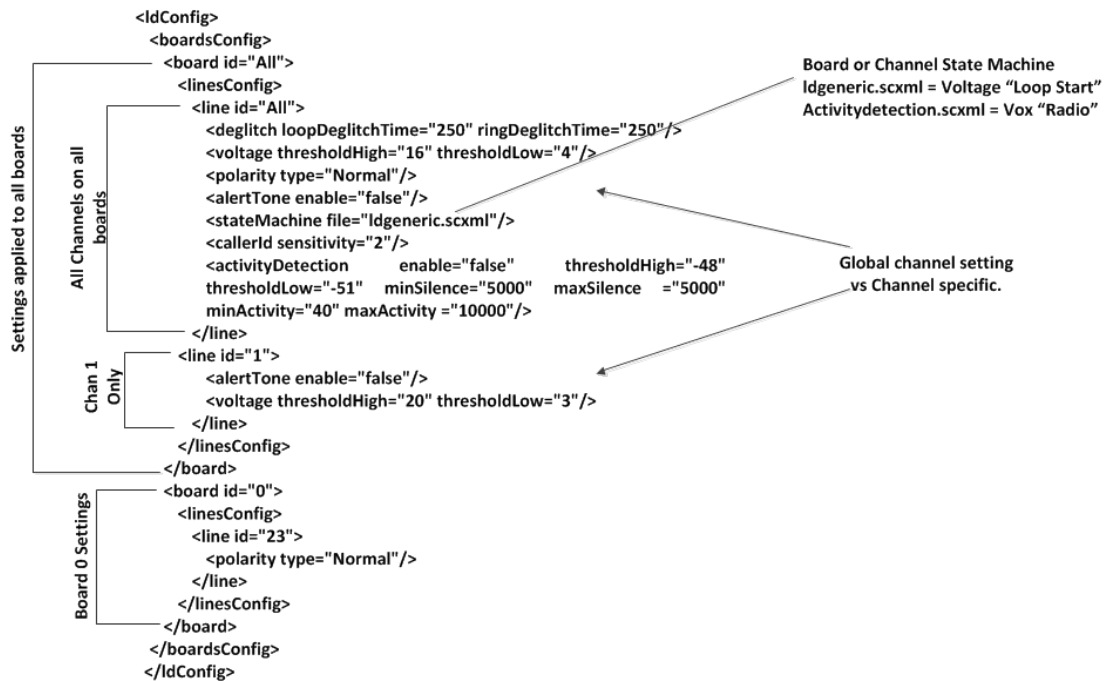
### Additional Configuration for Analog Trunk and Radio

The LD.xml file located in the target path of the Call Delivery is the most common file that needs to be configured for the analog environment. There is only one LD.xml file for all Analog cards. Using XML, you can specify in the LD.xml specific board and channel configurations. For example, board 0, channels 0-7 are voltage trigger based recording and 8-16 are VOX based recording.

Default Path: ..... \AUDIOCODES\SmartTAP\CD-AL\Config\

- LD.xml – Configuration file
- LD.xsd – Contains parameter definition and valid values.

Figure 9-12: LD.xml Basic Structure Diagram



Most Common Values that may need to be adjusted per board or channel.

Figure 9-13: Most Common Values to be Adjusted per Board or Channel

Element Name	Attribute Name	Description	Default
deglitch	loopDeglitchTime	Min = 10ms, Max = 2550ms. Ignore Voltage signal bounce on line during hang-up to avoid false call records. Recommend 500ms minimum.	250ms
	ringDeglitchTime	Min = 10ms, Max = 2550ms. Ignore ringing signal bounce on line on incoming call. Avoid false start of recording.	250ms
voltage	thresholdHigh	Min = -60vdc, Max = 60vdc. On Hook voltage must be greater than thresholdHigh.	16vdc
	thresholdLow	Min = -60vdc, Max = 60vdc. Off Hook voltage must be greater than	4vdc

Element Name	Attribute Name	Description	Default
		thresholdLow and below thresholdHigh.	
Polarity	type	Normal, will cosmetically change line polarity to positive. Reversed, will cosmetically change line polarity to negative.	normal
alertTone	enable	True = Audible tone will be played on line for both callers to hear to indicate call is being recorded.	false
stateMachine	file	ldgeneric.scxml = User for analog loop start lines activitydetection.scxml = Used for Vox or radio lines	ldgeneric.scxml
CallerID	sensitivity	Min = 2, Max = 128	2

Element Name	Attribute Name	Description	Default
activityDetection	enable		
	thresholdLow	Min = -60, Max = 0dBm, Must be less than thresholdHigh by 3dBm.	-51dBm
	thresholdHigh	Min = -60, Max = 0dBm, Must be greater than thresholdHigh by 3dBm.	-48dBm
	minActivity	Min = 40ms, Max = 2000, Used to trigger recording.	40ms
	maxActivity	Min = 40ms, Max = 20000	10000ms
	minSilence	Min = 500, Max = 20000	5000ms
	maxSilence	Min = 500, Max = 20000	5000ms
boardID		0 – 31	All
lineID		0 – 23, 24 channels per board	All

### Activity Detection

The Activity detector measures input signal energy in 20 ms samples. The energy measurement is then converted to average power and the result is compared against two programmable thresholds:

- The silence threshold thresholdLow
- The activity threshold thresholdHigh

Whenever the detector is in the silence state and the measured input signal energy remains above thresholdHigh for the minActivity duration, the detector changes to the activity state.

Whenever the detector is in the activity state and the measured input signal energy remains below thresholdLow for the minSilence duration, the detector changes to the silence state.

Figure 9-14: Activity Detection

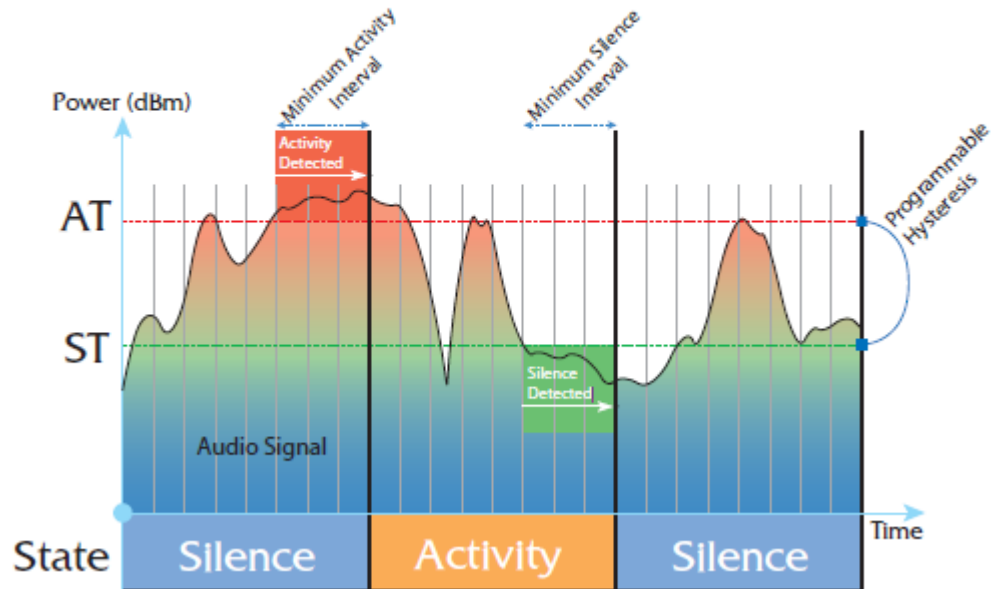
## Activity Detection

### Legend:

AT - Activity Threshold (dBm)

ST - Silence Threshold (dBm)

Hysterisis - Difference between AT and ST (dB)



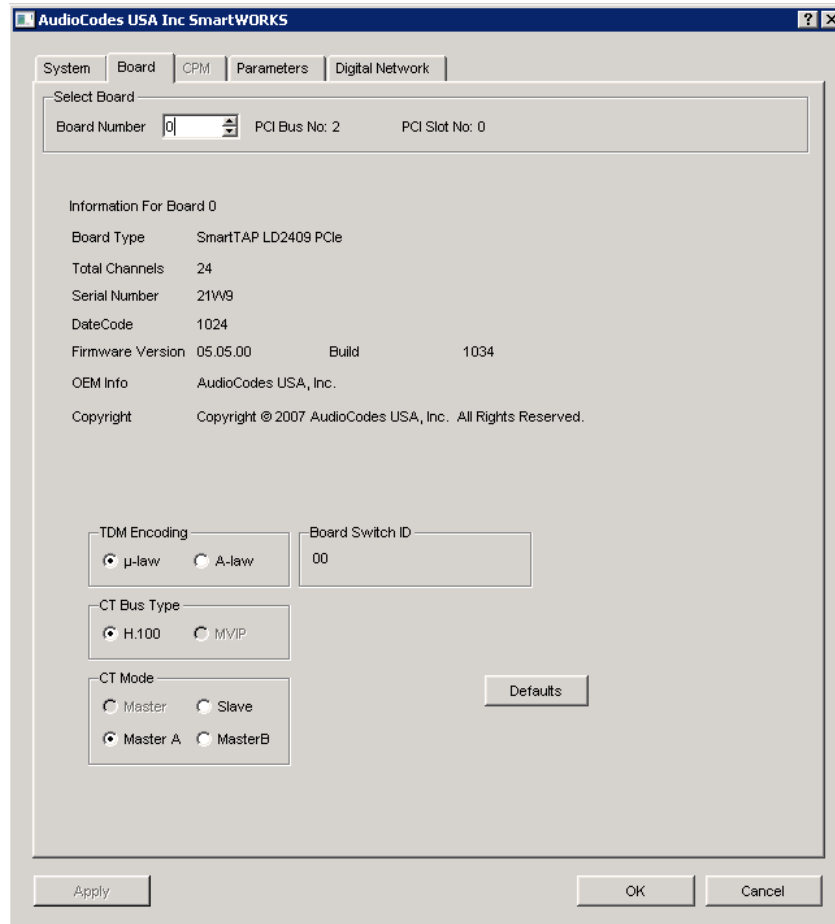
### SmartCONTROL

Use the applet in the Windows control panel to configure the Analog card using the Board tab. The only setting that requires configuration is TDM Encoding:

- U-LAW = North America
- A-LAW = Europe, APAC, etc...



Figure 9-15: Board Tab



## SIP Recording (SIPRec)

This section describes the SIP Recording (SIPRec) integration with SmartTAP 360° Live. In reference to the IETF Charter: The Session Recording Protocol (SIPREC) working group is chartered to define a SIP-based protocol for controlling a session (media) recorder.

<https://datatracker.ietf.org/doc/draft-ietf-siprec-protocol/>

The scope of the activity includes:

- Recorder Control
- Session metadata content and format
- Security mechanisms, including transport and media encryption
- Privacy concerns, including end-user notification
- Negotiation of recording media streams

## What is SIPRec?

The Session Recording Protocol is used for establishing an active recording session and reporting of the metadata of the communication session.

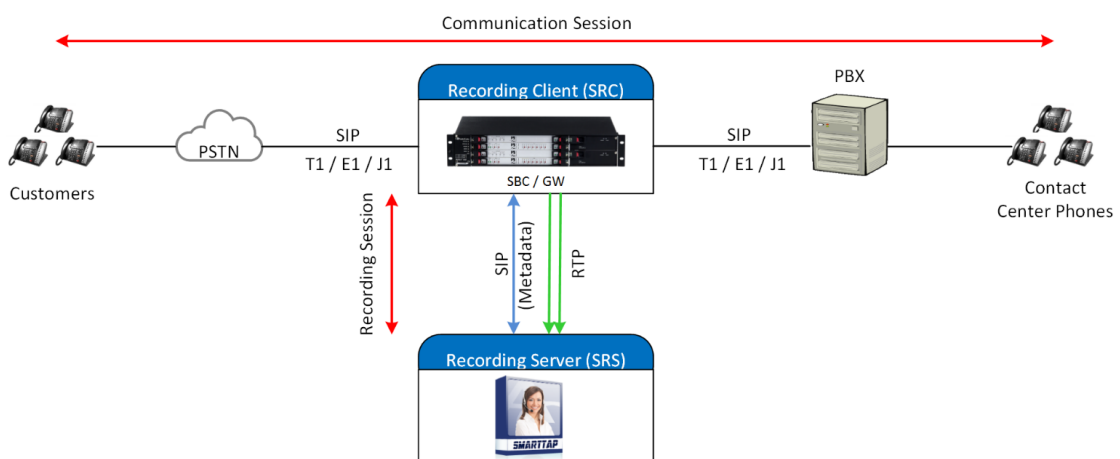
## Session Recording Server (SRS)

A Session Recording Server (SRS) is a SIP User Agent (UA) that acts as the sink of the recorded media. An SRS is a logical function that typically archives media for extended durations of time and provides interfaces for search and retrieval of the archived media.

## Session Recording Client (SRC)

A Session Recording Client (SRC) is a SIP User Agent (UA) that acts as the source of the recorded media, sending it to the Session Recording Server. In practice, a Session Recording Client could be a personal device (such as a SIP phone), a SIP Media Gateway (MG), a Session Border Controller (SBC), Media Server, or an Application Server. The Session Recording Client is also the source of the recorded session metadata.

**Figure 9-16: Session Recording Client**



### ➤ To configure SIPRec:

1. Ensure the Gateway / SBC (SRC) is properly configured to send call data to SmartTAP 360° Live (SRS).
2. Configure Call Delivery to receive from SRC.

## Configuring Gateway & SBC for SIP Recording

You must configure the AudioCodes E-SBC for interworking between the SBC and the SIP Recording Server for the following entities:

- Skype for Business Server environment
- SIP Trunking environment
- SIP Recording server

For configuring Load Balancing between multiple SmartTAP servers, see [Configuring Load Balancing on the SBC Device](#) on the next page

For configuring alternative routing, see [Configuring Alternative Routing on the SBC](#) on page 154



- For implementing the SBC SIP Recording configuration, the AudioCodes SBC must be installed with an appropriate License Key. For more information, contact your AudioCodes sales representative.
- For detailed information on configuring the SBC for SIP Recording, refer to the appropriate device SIP User's Manual.
- For deploying SmartTAP from the Azure Marketplace with SIPRec-based recording of calls, refer to [https://www.audiocodes.com/media/14106/SmartTAP\\_360°\\_Live-siprec-in-azure-marketplace-configuration-guide.pdf](https://www.audiocodes.com/media/14106/SmartTAP_360°_Live-siprec-in-azure-marketplace-configuration-guide.pdf)

### Configuring Load Balancing on the SBC Device

This step describes how to configure the SBC for load balancing. This configuration is required when SmartTAP 360° Live is deployed on multiple servers to balance the load.

➤ **To configure Gateway & SBC for SIP Recording:**

1. Open the Proxy Sets table (**Setup** menu > **Signaling & Media** tab > **Core Entities** folder>**Proxy Sets**).
2. Add all the CD-SIPREC servers to the SRS's Proxy Set under 'CORE ENTITIES > Proxy Sets > [Index####] > Proxy Address'.



This step is only necessary when there is more than one SmartTAP 360° Live server deployed.

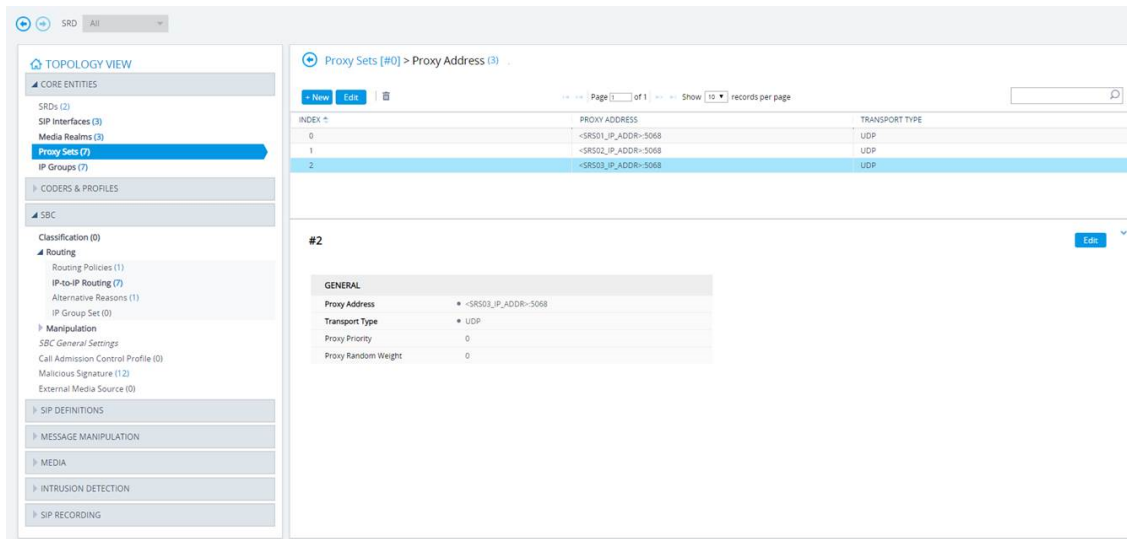
Figure 9-17: Proxy Set

The screenshot displays the 'Proxy Sets (7)' configuration page. At the top, there is a table with columns: INDEX, NAME, SRD, SBC IPv4 SIP INTERFACE, PROXY KEEP-ALIVE TIME [SEC], REDUNDANCY MODE, and PROXY HOT SWAP. The first row shows index 0, name 'Proxy\_SRS', SRD 'SR1 (R1)', SBC IPv4 SIP INTERFACE 'SIPInterface\_0', PROXY KEEP-ALIVE TIME '60', REDUNDANCY MODE 'Disable', and PROXY HOT SWAP 'Disable'.

Below the table, the configuration details for the selected Proxy Set are shown in several sections:

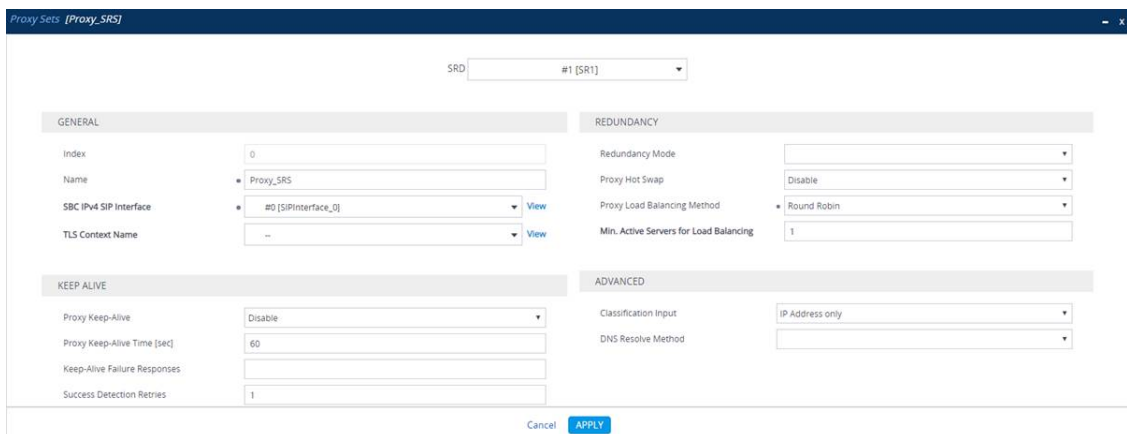
- GENERAL:** Name: Proxy\_SRS; SBC IPv4 SIP Interface: # [SIPInterface\_0]; TLS Context Name: # [-].
- KEEP ALIVE:** Proxy Keep-Alive: Disable; Proxy Keep-Alive Time [sec]: 60; Keep-Alive Failure Responses: Success Detection Retries: 1; Success Detection Interval: 10; Failure Detection Retransmissions: -1.
- REDUNDANCY:** Redundancy Mode: Disable; Proxy Hot Swap: Disable; Proxy Load Balancing Method: Round Robin; Min. Active Servers for Load...: 1.
- ADVANCED:** Classification Input: IP Address only; DNS Resolve Method.
- PROXY ADDRESS:** A table with columns PROXY ADDRESS and TYPE, listing three entries: -SR501\_IP\_ADDR-5068 (UDP), -SR502\_IP\_ADDR-5068 (UDP), and -SR503\_IP\_ADDR-5068 (UDP).

Figure 9-18: Proxy Set IP Addresses



- After adding the SIPREC servers to the list, edit the Proxy Set's configuration under **Core Entities > Proxy Sets > [Index####] > Edit'** and set 'Proxy Load Balancing Method' to 'Round Robin'.

Figure 9-19: Proxy Load Balancing Method



## Configuring Alternative Routing on the SBC

This step describes how to configure an alternative reason (reject messages). The RELEASE CAUSE should match the reason configured in CD-SIPREC config file (see . [CD-SIPREC Configuration](#) on page 179). This configuration is required when SmartTAP 360° Live is deployed on multiple servers as a load.

### ➤ To configure alternative routing:

- Open the Alternative Reasons page (**Setup** tab > **SBC** folder > **Routing** > **Alternative Reasons**).

Figure 9-20: Alternative Routing Reasons

The screenshot shows the 'Alternative Routing Reasons' configuration page. The left sidebar contains a navigation menu with the following items:

- TOPOLOGY VIEW
- CORE ENTITIES
  - SRDs (2)
  - SIP Interfaces (3)
  - Media Realms (3)
  - Proxy Sets (7)
  - IP Groups (7)
- CODERS & PROFILES
  - SBC
    - Classification (0)
    - Routing
      - Routing Policies (1)
      - IP-to-IP Routing (7)
      - Alternative Reasons (2)
      - IP Group Set (0)
    - Manipulation
      - SBC General Settings
      - Call Admission Control Profile (0)
      - Malicious Signature (1 2)
      - External Media Source (0)
- SIP DEFINITIONS
- MESSAGE MANIPULATION
- MEDIA
- INTRUSION DETECTION
- SIP RECORDING

The main content area displays a table with the following data:

INDEX	RELEASE CAUSE
0	486 Busy
1	4xx

Below the table, there is a 'GENERAL' section with the following configuration:

#0

GENERAL

Release Cause: 486 Busy

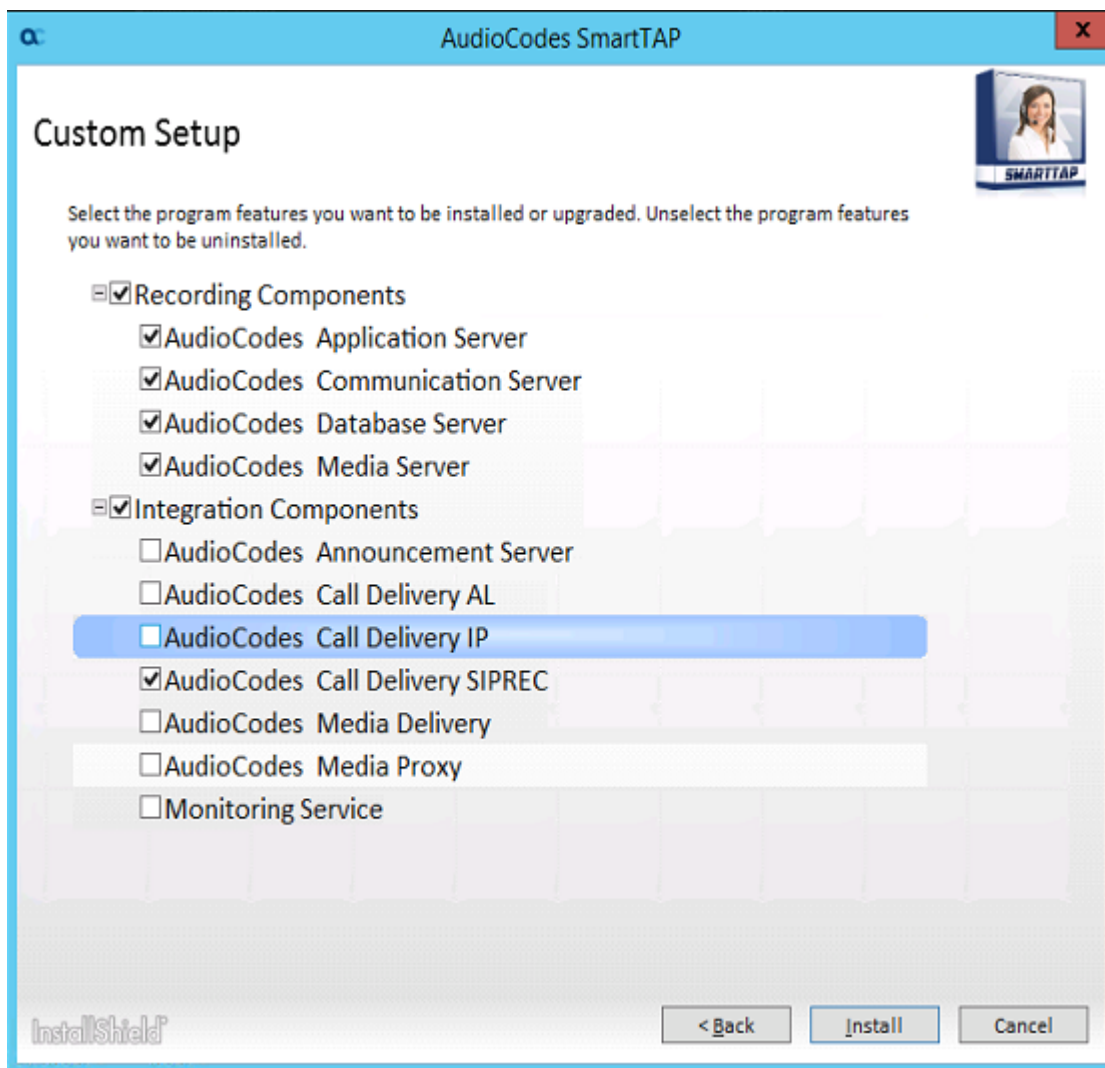
## Installing SmartTAP 360° Live for SIP Recording

This section describes how to install SmartTAP for SIP Recording.

### ➤ To install SmartTAP recording:

1. Launch install.bat from the "Suite" folder with "administrator" privileges.
2. Select the check boxes for the components as shown in the figure below.

Figure 9-21: Install SIP Recording



3. Click **Install** and then choose the default configuration.
4. Proceed to [Configuring Call Delivery for SIP Recording](#) below.

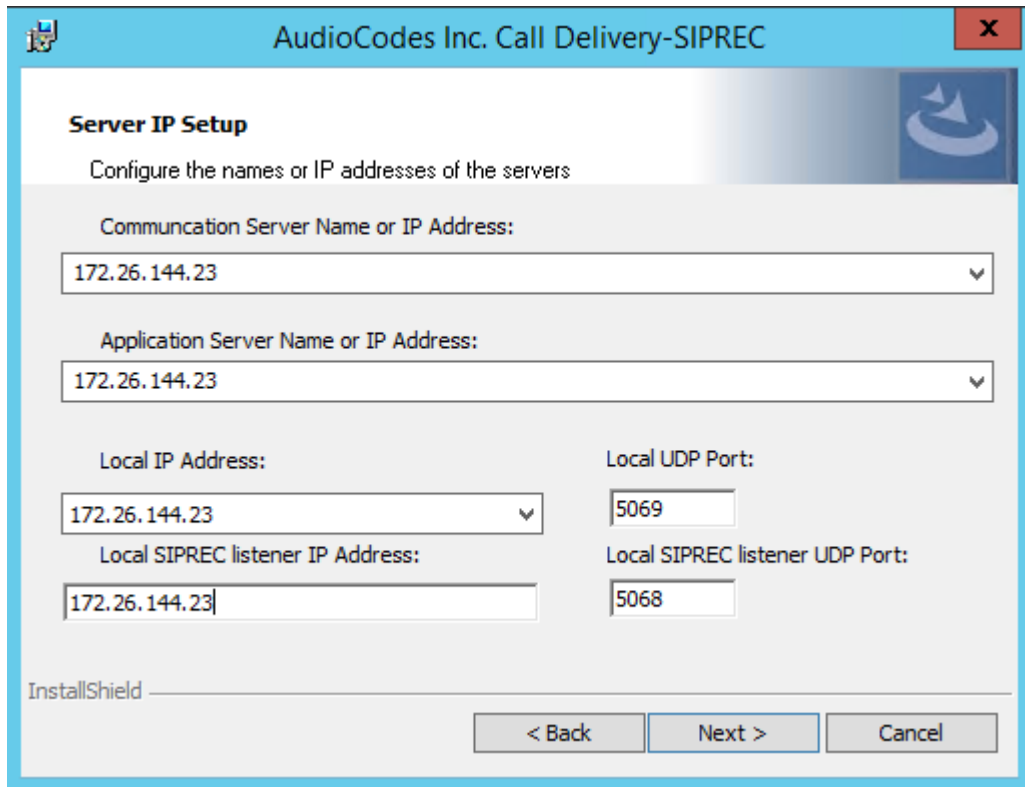


It is highly recommended to configure the Firewall with the required ports to ensure proper communication prior to the software installation. See [Firewall Configuration](#) on page 59.

## Configuring Call Delivery for SIP Recording

During the software installation, configure the CD with the necessary information to connect to the SRC. Configure the Local SIPRec listener IP Address and Port on the SmartTAP server that will be used to receive from the SRC as in the following image. In case of distributed or remote branch deployment, type in the real IP address of the Application Server (AS), Communication Server (CS), and the local IP (don't type in 127.0.0.1). The Local IP and The SIPREC listener IP should be of the server the CD-SIPREC component is running on. In case of all-in-one deployment use the drop down list and choose the SmartTAP IP address.

Figure 9-22: Server IP Setup



Assuming the default parameters are insufficient, additional configuration options are available in the following configuration files.

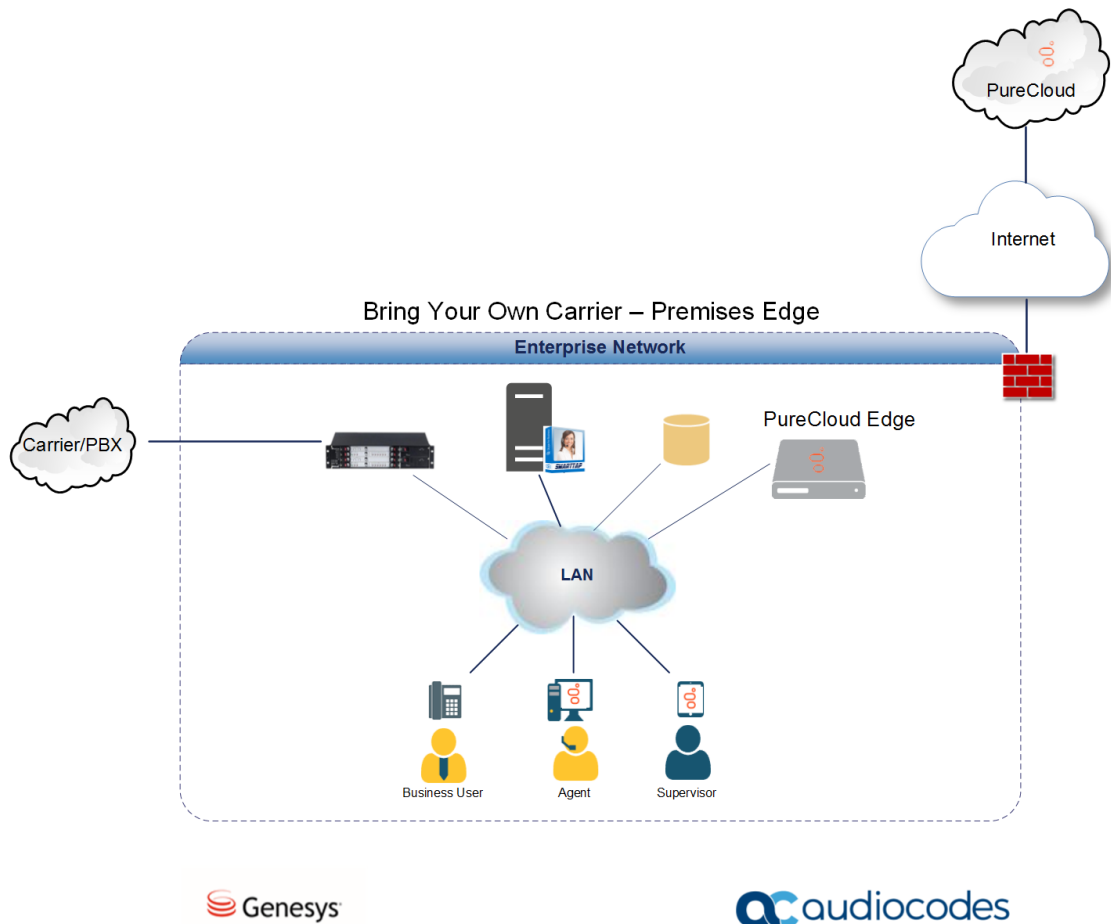
Table 9-3: SIP Recording – Additional Configuration Files

Configuration File	Purpose
CdSipRecConfig.xml	Sets the IP & Port to receive the SIPRec data. Typically the SmartTAP server.
Calldeliveryconfig.xml	<ul style="list-style-type: none"> <li>■ Sets the IP of the SmartTAP Application server. The default value is 127.0.0.1 assuming that the AS and CD are installed on the same server.</li> <li>■ Configures the Regular Expressions to match the specific needs of each customer network. Refer to Target Attributes for more information (see <a href="#">Verify the Target List in Each Call Delivery</a> on page 178).</li> </ul>

## Recording Genesys PureCloud Contact Center Calls Locally

SmartTAP 360° Live can record PureCloud Contact Center calls and save them on the SmartTAP 360° Live server or on a local storage device. The following diagram illustrates the solution architecture.

Figure 9-23: Genesys PureCloud Contact Center Calls



This solution requires termination of the PSTN calls on-premises and requires a Bring Your Own Carrier (BYOC) Premises telephony connection. The BYOC Premises makes it possible to use a premises-based trunk and requires the installation of a PureCloud Edge server. AudioCodes SBC provides the connectivity between a service provider's network and the PureCloud Edge server and integrates with SmartTAP 360° Live to record these calls. SmartTAP 360° Live records the Contact Center calls while persisting and presenting the associated call's "interaction id" as part of the recording meta-data in the SysCall ID field.

- The SBC device must be configured to ensure seamless integration of the call recordings mechanism (see [Configuring Message Manipulation Rules Genesys PureCloud Contact Center Calls](#) below)
- The SmartTAP 360° Live device can be added to the PureCloud Contact Center (see [Adding SmartTAP to the Genesys PureCloud Contact Center User Interface](#) on page 160)

## Configuring Message Manipulation Rules Genesys PureCloud Contact Center Calls

This section describes the configuration of message manipulation rules on the SBC device for supporting the Genesys PureCloud Contact Center solution. These message manipulation rules are for SIP messages recorded and saved by the SmartTAPRecording server.





Ensure that you have configured the device for SIP Recording (see [Configuring Gateway & SBC for SIP Recording](#) on page 152) and have configured all other relevant SIP entities, including IP Groups for PureCloud and the SmartTAP server. For further assistance, contact AudioCodes support.

➤ **To configure message manipulation rules on the SBC:**

1. Open the Message Manipulations table (**Setup** tab > **Signaling & Media** folder > **Message Manipulations**).
2. Configure Message manipulation rules as shown in the following table:

**Table 9-4: Message Manipulation Rules**

Configure the following rules (Manipulation Set IDs are examples only):

- Index 0: Verifies the inbound request from the PureCloud IP Group to determine whether SBC call leg should be recorded. If true, stores header.x-inin-cnv in var.session.0”.
- Index 1: Verifies the Var.Session.0 value from Index 0, inserts in Header.x-audc-call-id and sends to the SmartTAP Call Recording server IP Group.

Index	Manipulation Name	Manipulation Set ID	Message Type	Condition	Action Subject	Action Type	Action Value	Row Role
0	Store x-header in var.session	11	Any	Header.-header.x-inin-cnv.-contentexists And Header header.x-inin-cnv.-content != ""	Var.Session.0	2 (Modify)	Header.x-inin-cnv	0 (Use Current Condition)
1	Send x-header to SIPRec	12	Invite.Request	Var.Session.0 != ""	Header.x-audc-call-id	0 (Add)	Var.Session.0	0 (Use Current Condition)

3. Open the IP Group page (**Setup** tab > **Signaling and Media** folder > **IP Groups**).

4. Add an IP Group for PureCloud.
5. Set **Inbound Manipulation Set** to 11.

## MESSAGE MANIPULATION

Inbound Message Manipulation Set

11

6. Add and IP Group for the SmartTAP Server.
7. Set **Outbound Message Manipulation Set** to 12.

## MESSAGE MANIPULATION

Inbound Message Manipulation Set

-1

Outbound Message Manipulation Set

12

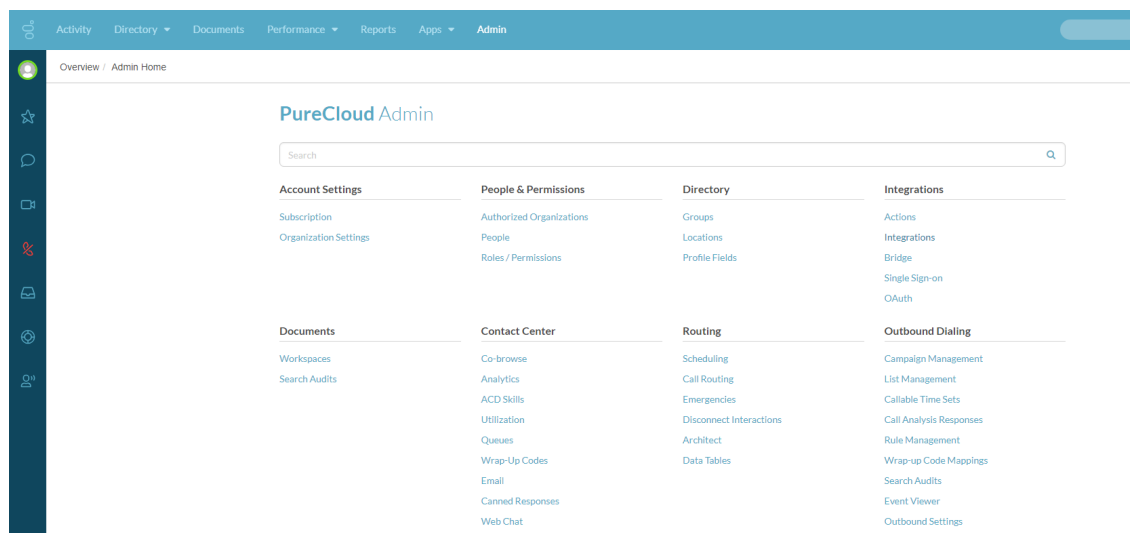
## Adding SmartTAP to the Genesys PureCloud Contact Center User Interface

This section describes how to add the SmartTAP application to the PureCloud Contact Center user interface.

### ➤ To add SmartTAP to Genesys PureCloud :

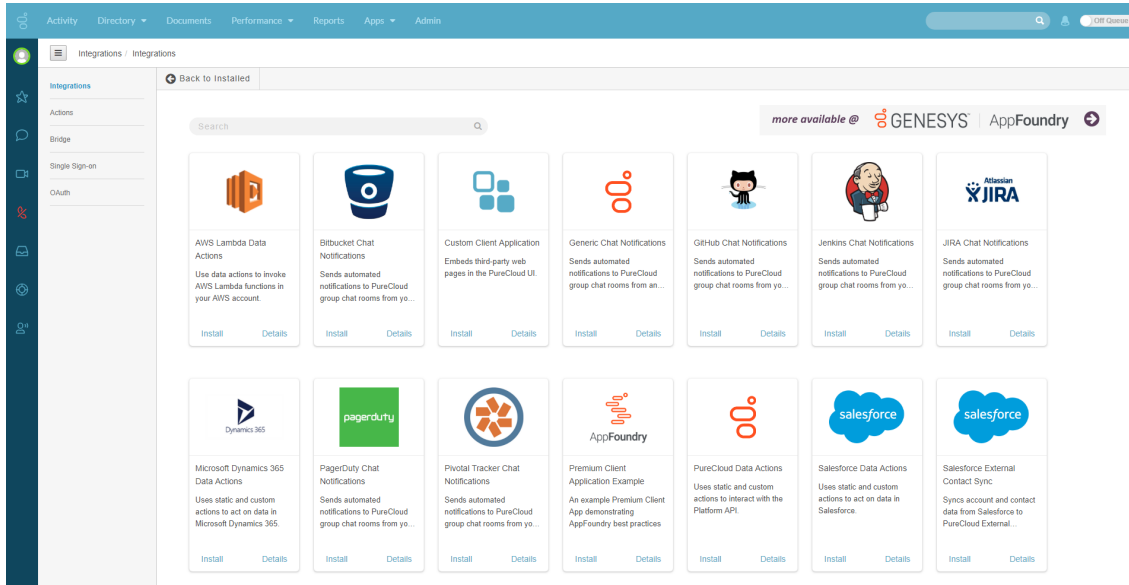
1. Open the PureCloud Admin interface.

**Figure 9-24: Genesys PureCloud Admin**



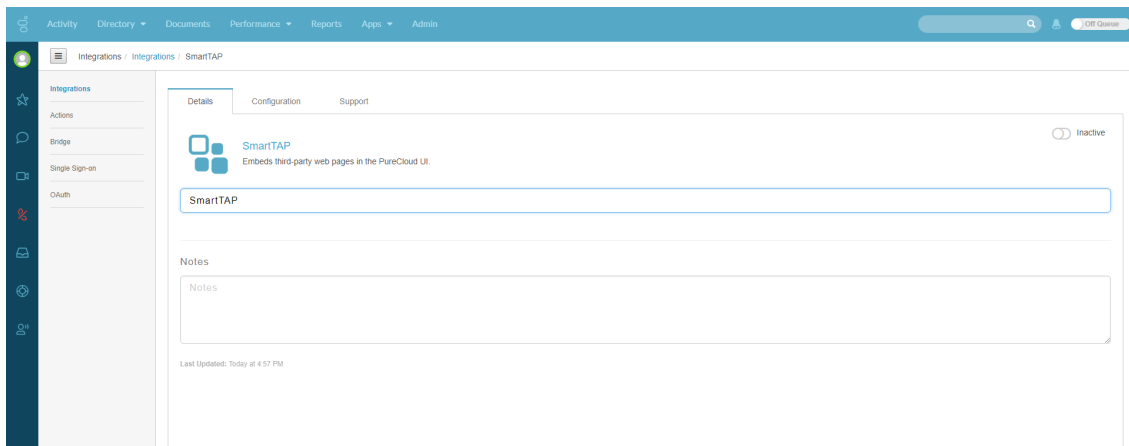
2. From the Integrations menu, choose **Integrations**, select to **add an integration** and choose to **install on the Custom Client Application** tile.

Figure 9-25: Custom Client Application Tile

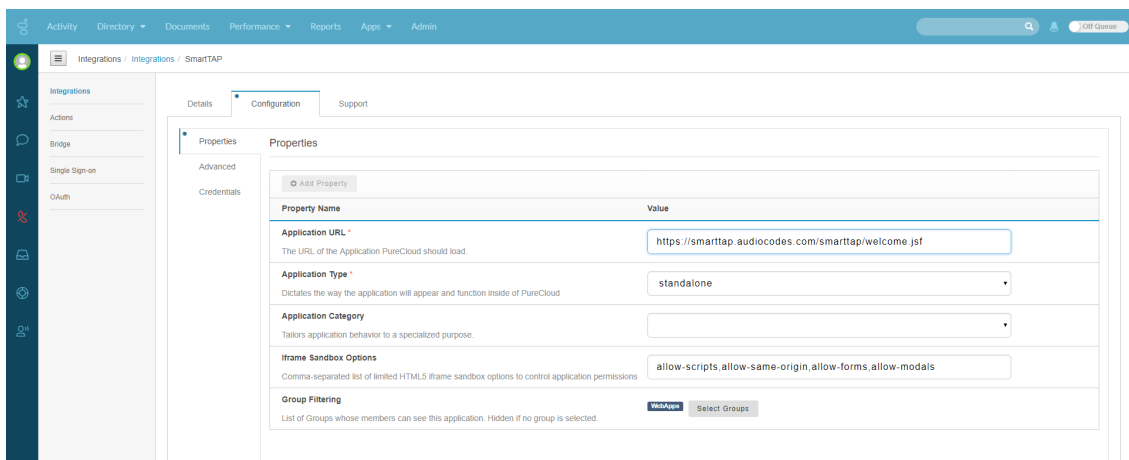


3. In the Integrations menu, name the application **SmartTAP**.

Figure 9-26: Application Name

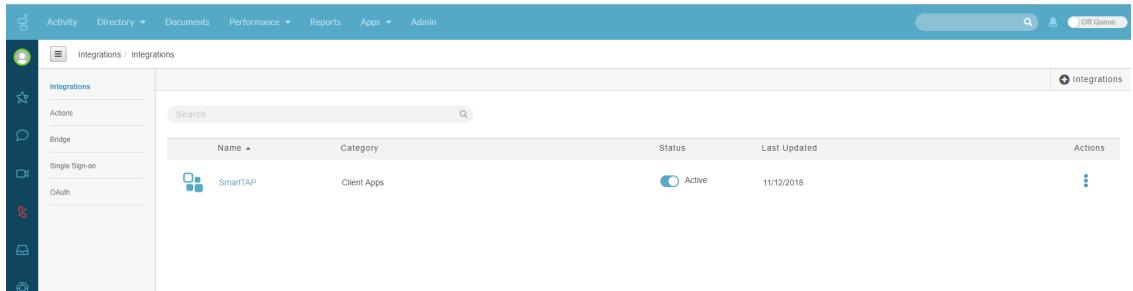


4. Under the **Configuration** tab paste the SmartTAP URL in the Application URL field:



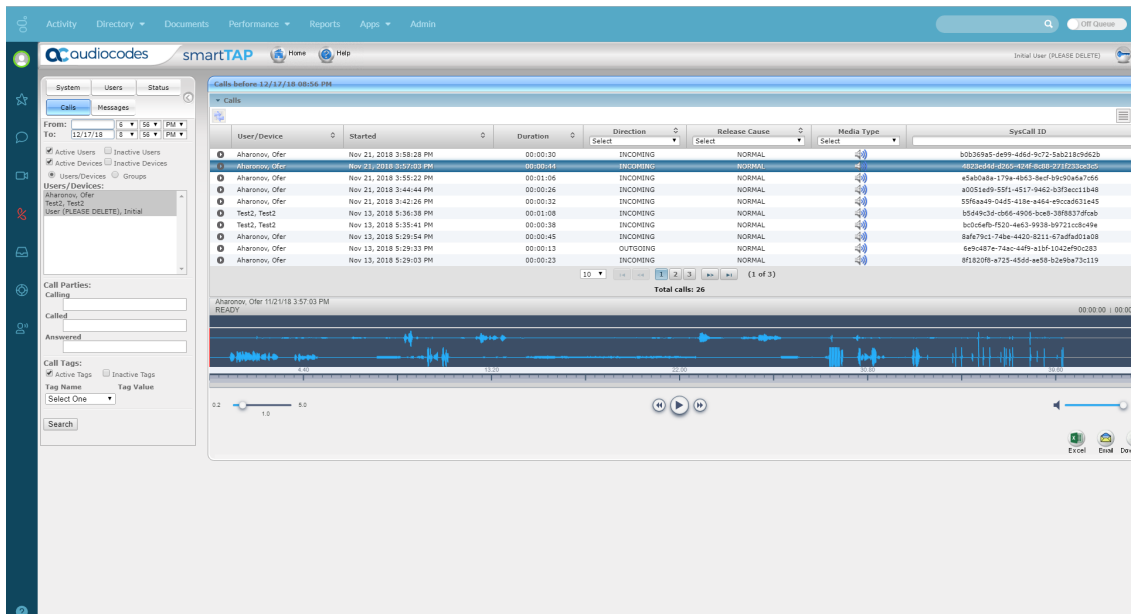
4. Save and Activate the application.

Figure 9-27: Save the Application



5. To open the SmartTAP Web, from the Toolbar choose **Apps**.

Figure 9-28: SmartTAP Opened from Genesys PureCloud



## 10 Additional Configuration Options

This chapter describes the following additional configuration options:

- [Configuring Digital Signatures](#) below
- [Configuring LDAP](#) on the next page
- [Configuring SSO](#) on page 165
- [Configuring HTTP/S](#) on page 165

### Configuring Digital Signatures

Configuring Digital Signature is a two-stage process:

- Setup in the SmartTAP 360° Live Web interface – Refer to the Certificate and Digital Signature sections in the *SmartTAP 360° Live Administrator Guide*
- Setup at the Client PC (each client PC) see [Installing the Digital Signatures Property Sheet](#) below

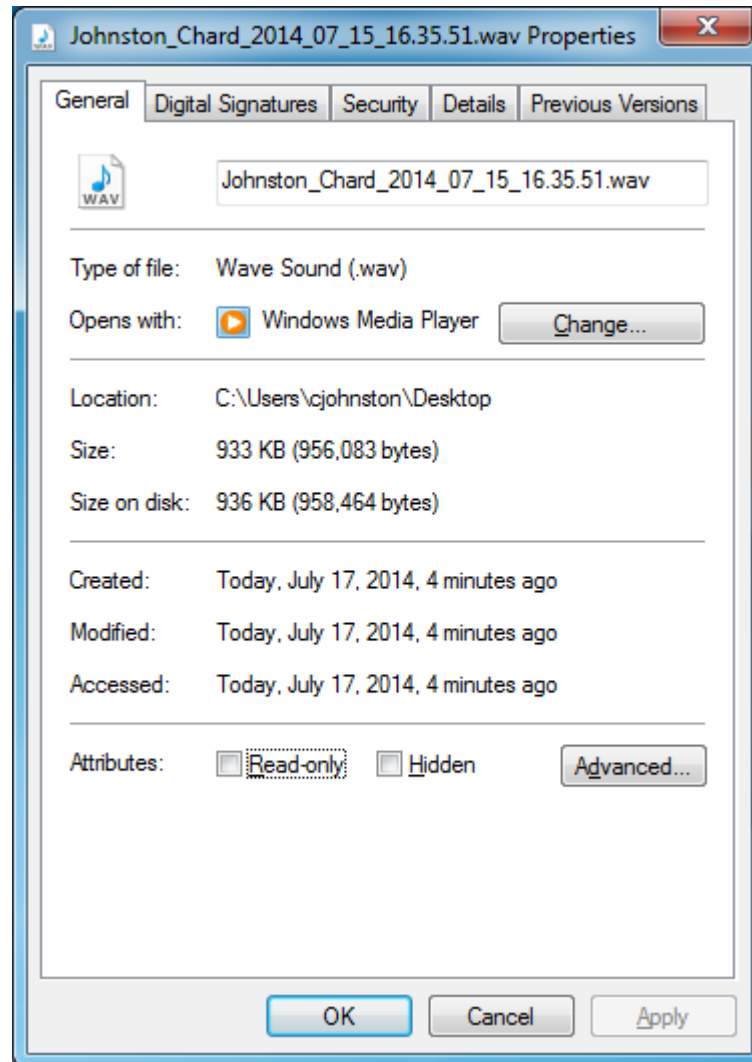
### Installing the Digital Signatures Property Sheet

This section describes how to install the digital signatures property sheet.

➤ **To configure the PC client:**

1. Open SmartTAP installer root folder and navigate to Tools\DigitalSignaturesPropertySheet\  
2. Right-click the install.bat file and select **Run as administrator**.
3. Once installed, the Digital Signatures tab is displayed in the file properties of the downloaded audio recording.
4. Click the **Digital Signatures** tab to view the certificate and verify it is from a trusted source.

Figure 10-1: Digital Signatures



You may need to reboot the PC to complete the installation.

## Configuring LDAP

The SmartTAP LDAP feature allows you to use your Windows Active Directory users and groups in SmartTAP 360° Live, and map them into users, groups and security groups in SmartTAP 360° Live. The users and groups are not imported into SmartTAP 360° Live, instead they are represented in real time Active Directory image. For example, if an AD attribute such as a user name is modified, this change is reflected almost instantly in SmartTAP 360° Live.

To configure the LDAP server connection, refer to the *SmartTAP 360° Live Administrator Guide*.

## Pre-Requisites

- Create or provide a user account with read-only access to Active Directory. Should be part of read-only domain controller group]

- The password for this service account should be set to “never expire”

## Configuring SSO

Single Sign-on (SSO) simplifies the login process for domain administrators. The administrator logs into their machine using domain credentials. The user then attempts to access the Application Server's web service via a web browser such as Edge, Chrome or Firefox. When SSO is not configured, the administrator is directed to a login form where Username and Password are entered and sent to SmartTAP to authenticate. When SSO is configured, the administrator is authenticated in the background through Active Directory using the same domain credentials that were used to log into the machine. This mechanism bypasses the login page and immediately opens the Welcome page.



The SmartTAP server must be added to the domain. For information on configuring SSO, refer to the *SmartTAP 360° Live Administrators Manual*.

## Configuring HTTP/S

This section describes how to configure HTTP/S.

### Disabling HTTP Communications on Application Server (Optional)

This section describes how to disable non-encrypted HTTP communication on SmartTAP Application Server. This ensures that all communications with the Application Server are encrypted. This can be done automatically or manually. If you are implementing SSL (HTTPS), then this action ensures that all incoming traffic to the Application Server is over HTTPS.



Configuring SmartTAP Application Server for HTTPS does not automatically disable the HTTP (non-encrypted) interface. While the SmartTAP management Web page is available over HTTPS, SmartTAP components would continue to communicate with SmartTAP Application Server over HTTP. To convert the entire application to encrypted communications (over SSL), after disabling HTTP in Application Server as described below, SmartTAP components must be configured as described in Section [Configuring SmartTAP 360° Live Components for HTTPS](#) on page 167 (Configuring SmartTAP Components for HTTPS).

### Automatic Disabling of HTTP

This section describes the automatic procedure. This method requires a mandatory username and password to access Wildfly management console.

#### ➤ Do the following:

1. Go to the Application Server Install directory.
2. Locate the PowerShell directory. For example C:\Program Files\AUDIOCODES\SmartTAP\AS\PowerShell.

3. Run the DisableHttp.ps1 script (located in the “Tools” folder of SmartTAP installation) with the following parameters:
  - [Mandatory] managementIP – IP address of HTTP Management interface (Application Server IP)
  - Management user credentials:
    - ◆ [Mandatory] username
    - ◆ [Mandatory] password – input prompt will be displayed as a part of the current run
  - [Optional] jbossCliPath – Full path to jboss-cli.bat (Command Line Interface)

For example:

```
DisableHttp.ps1 -managementIP 192.168.1.100 -username username - -
jbossCliPath C:\Program Files\AUDIOCODES\SmartTAP\AS\Bin\jboss-cli.bat
```

4. Restart the requested service.

### Manual Disabling of HTTP

This section describes how to manually disable HTTP.

#### ➤ Do the following:

1. Stop the SmartTAP Application Server service.
2. Edit ../AudioCodes/SmartTAP/AS/Domain/Configuration/domain.xml
3. In urn:jboss:domain:undertow:4.0, comment out the listener element:

Remove http-listener

4. Under urn:jboss:domain:messaging-activemq:2.0 subsystem:
  - Change element http-connector attribute Value socket-binding from “http” to “https”
  - Change http-connector-throughput socket-binding from “http” to “https”
  - Change http-acceptor http-listener from “default” to “https”
  - Change http-acceptor-throughput http-listener from “default” to “https”
5. Under subsystem urn:jboss:domain:remoting:4.0 change http-remoting-connector connector-ref from “default” to “https”.
6. Restart the SmartTAP Application service.



## Configuring SmartTAP 360° Live Components for HTTPS

This section describes how to configure HTTPS on SmartTAP 360° Live components. CA Root Certificate/s used to sign the Application Server certificate must be installed on each machine where SmartTAP 360° Live components are installed. SmartTAP 360° Live supports HTTPS/TLS 1.2.

- [Communication Server for HTTPS](#) below
- [Call Delivery with HTTPS](#) below
- [Media-Proxy with HTTPS](#) on the next page
- [Announcement Server with HTTPS](#) on page 169
- [Remote Transfer Service with HTTPS](#) on page 169
- [Health Monitor with HTTPS](#) on page 170
- [Media Delivery with HTTPS](#) on page 170
- [Media Server with HTTPS](#) on page 171
- [CD-Live with HTTPS](#) on page 171



For generating and loading certificates, see 'Generating and Loading HTTPS Certificates' in the *SmartTAP 360° Live Administrator Guide*.

### Communication Server for HTTPS

This section describes how to configure the connection with the Communication server over HTTPS.

➤ **Do the following:**

1. On every host where CS is installed, check file "`<CS_installation_Dir>\server-ngp\data\mbeans\managedDeviceProperties.properties`" and note that the entry "`HOST=...`" contains a value which is present in the SAN part of the AS certificate. If it is not, change it accordingly.
2. Find the entry "`port=-1`" and change it to "`port=443`".
3. Change the entry "`scheme=http`" to "`scheme=https`".
4. Restart the CS service for the changes to take effect.

### Call Delivery with HTTPS

This section describes how to configure the connection with the Call Delivery server over HTTPS.

➤ **Do the following:**

1. Edit the following file: "`...\AudioCodes\SmartTAP\CD-IP\Config\calldeliveryconfig.xml`"

2. Use an FQDN in the certificate SAN field in the Call Delivery configuration file `calldeliveryconfig.xml` (and make sure that DNS resolution is working correctly for this FQDN).

An example of `calldeliveryconfig.xml` HTTPS settings is shown below:

```
<applicationServer>
  <recorder ip="SmartTAP.company.com" port="443">
    <protocols>
      <protocol>https</protocol>
    </protocols>
  </recorder>
</applicationServer>
```

3. Edit the following file: “...\AudioCodes\SmartTAP\CD-IP\Config\persistence.xml
4. Use a FQDN in the certificate SAN field in the Call Delivery configuration file `persistence.xml` (and make sure that DNS resolution is working correctly for this FQDN).

```
url="https://SmartTAP.company.com:443"
```

Where “SmartTAP.company.com” is the FQDN of the SmartTAP

5. Restart the service to apply changes.

### Media-Proxy with HTTPS

This section describes how to configure the connection with the Media Proxy server over HTTPS.

#### ➤ Do the following:

1. Edit file `System.config` in “..\MP\Config” and change `asList` attribute’s value in the following section of the Media Proxy Service file:

```
<System asList="http://AS_FQDN:80"/>
```

2. Modify to the following:

```
<System asList="https://AS_FQDN:443"/>
```

3. Make sure `AS_FQDN` is included in the certificate SAN field and is resolvable by DNS.
4. Restart the service to apply changes.

## Announcement Server with HTTPS

This section describes how to configure the connection with the Announcement server over HTTPS.

### ➤ Do the following:

1. Manually edit asList attribute's value in "..\AS\Config" and change the following section of the Announcement Service System.config file:

```
<System asList="http://ASIP:80"/>
```

2. Change to the following:

```
<System asList="https://AS_FQDN:443"/>
```

3. Make sure AS\_FQDN is included in the certificate SAN field and is resolvable by DNS.
4. Restart the service to apply changes.

## Remote Transfer Service with HTTPS

This section describes how to configure the connection with the Remote Transfer Service over HTTPS.

### ➤ Do the following:

1. Edit file System.config in "..\RTS\Config" and change asList attribute's value in the following section of the Remote Transfer Service file:

```
<System asList="http://AS_FQDN:80"/>
```

2. Modify to the following:

```
<System asList="https://AS_FQDN:443"/>
```

3. Use the FQDN that is found in the certificate SAN field in these files.

```
url="https://SmartTAP.company.com:443"
```

Where "SmartTAP.company.com" is the FQDN of the SmartTAP Server



Make sure DNS resolution is working correctly for this FQDN.

4. Restart the RTS service to apply changes.

## Health Monitor with HTTPS

This section describes how to configure the connection with the Health Monitor over HTTPS.

### ➤ Do the following:

1. Edit the file `Tools\HealthMonitor\Config\RecordingHealthMonitor.config`
2. Find this section in the configuration file:

```
<RestApi>
  <Address>http://[ address which is present in the SAN </Address>
  <Username></Username>
  <SecurityToken></SecurityToken>
</RestApi>
```

3. Make the highlighted changes:

```
<RestApi>
  <Address>https://SmartTAP.company.com]</Address>
  <Username></Username>
  <SecurityToken></SecurityToken>
</RestApi>
```

Where "SmartTAP.company.com" is the FQDN of the SmartTAP

## Media Delivery with HTTPS

This section describes how to configure the Media Delivery over HTTPS.

### ➤ Do the following:

1. Edit the following file: `".....\AudioCodes\SmartTAP\MD\Config\persistence.xml"`
2. Use a FQDN present in the certificate SAN field in Media Delivery configuration file `persistence.xml` (and make sure that DNS resolution is working correctly for this FQDN. Media Delivery may be connected to multiple SmartTAP servers, so each of these connections must be edited in the file.

```
<?xml version="1.0" encoding="UTF-8" standalone="no" ?>
<callDeliveryPersist xmlns="http://www.audiocodes.com/calldelivery">
  <managedDevices>
    <managedDevice id="12"
url="https://SmartTAP.company.com:443"></managedDevice>
    <managedDevice id="18"
url="https://smarttap2.company.com:443"></managedDevice>
```

```
</managedDevices>
<version>1</version>
</callDeliveryPersist>
```

3. Restart the service to apply changes.

### Media Server with HTTPS

This section describes how to configure the Media Server over HTTPS.

#### ➤ Do the following:

1. Edit the following file: "...\\AudioCodes\\SmartTAP\\MS\\server\\bin\\mediaserverconfig.xml"
2. Use an FQDN in the certificate SAN field in the Call Delivery configuration file mediaserverconfig.xml (and make sure that DNS resolution is working correctly for this FQDN).

An example of mediaserverconfig.xml HTTPS settings is shown below:

```
<applicationServer>
  <recorder ip="SmartTAP.company.com" port="443">
    <protocols>
      <protocol>https</protocol>
    </protocols>
  </recorder>
</applicationServer>
```

3. Edit the following file: "...\\AudioCodes\\SmartTAP\\MS\\server\\bin\\persistence.xml"
4. Use an FQDN in the certificate SAN field in the Media Server persistence.xml (make sure that DNS resolution is working correctly for this FQDN).

```
url="https://SmartTAP.company.com:443"
```

Where "SmartTAP.company.com" is the FQDN of the SmartTAP

5. Restart the service to apply changes.

### CD-Live with HTTPS

This section describes how to configure the connection with the CD-Live server over HTTPS.

#### ➤ To configure HTTPS transport:

1. Using notepad or a text editor, open the 'appsettings.json' configuration file, and set the AS FQDN address and port 443:

```
"SmartTapRestClientConfig": {
```

```
"BaseUri": "https://<FQDN>:443/",
```

2. Close the file and save.

## Configuring Syslog Server Connection

This section describes how to setup the connection with a syslog server.

### Skype for Business Plug-in

This section describes how to setup the syslog server connection between the Skype for Business Front End and a syslog server. This procedure must be setup on every Front End machine in the managed pool.

#### ➤ To setup connection:

1. Obtain the machine ip that runs the system viewer , EX: 172.17.127.XXX.
2. In the front-end machine, edit the C:\Program Files\AudioCodes\SmartTAP\Lync Plug-in\LyncPlugIn.exe.config

Add / Edit required syslog appender. Example : Log and Error logs are defined in the <log4net debug="true"> section (this section does not include a MAC address)

```
<appender name="RemoteSyslogAppender"
type="log4net.Appender.RemoteSyslogAppender">
  <facility value="Local7" />
  <layout type="log4net.Layout.PatternLayout" value="LPI: %d{dd MMM yyyy
HH:mm:ss,fff } %-5p %m\r\n" />
  <remoteAddress value="172.17.127.XXX " />
  <RemotePort value="514" />
</appender>
<appender name="RemoteSyslogAppenderError"
type="log4net.Appender.RemoteSyslogAppender">
  <facility value="user" />
  <layout type="log4net.Layout.PatternLayout" value="LPI: %d{dd MMM yyyy
HH:mm:ss,fff } %-5p %m\r\n" />
  <param name="Threshold" value="ERROR" />
  <remoteAddress value="172.17.127.XXX " />
</appender>
```

3. On the front-end machine, edit the C:\Program Files\AudioCodes\SmartTAP\Lync Plug-in\LyncPlugIn.exe.config

Edit the <root> section

Add

```
<appender-ref ref="RemoteSyslogAppender"></appender-ref>
<appender-ref ref="RemoteSyslogAppenderError"></appender-ref>
```

4. Save the file and restart the Plug-in.

## Location-Based Targeting in SmartTAP

This section describes how to assign targets to specific Call Delivery components by assigning a location attribute to each instance of the Call Delivery server and then mapping targets to those locations.

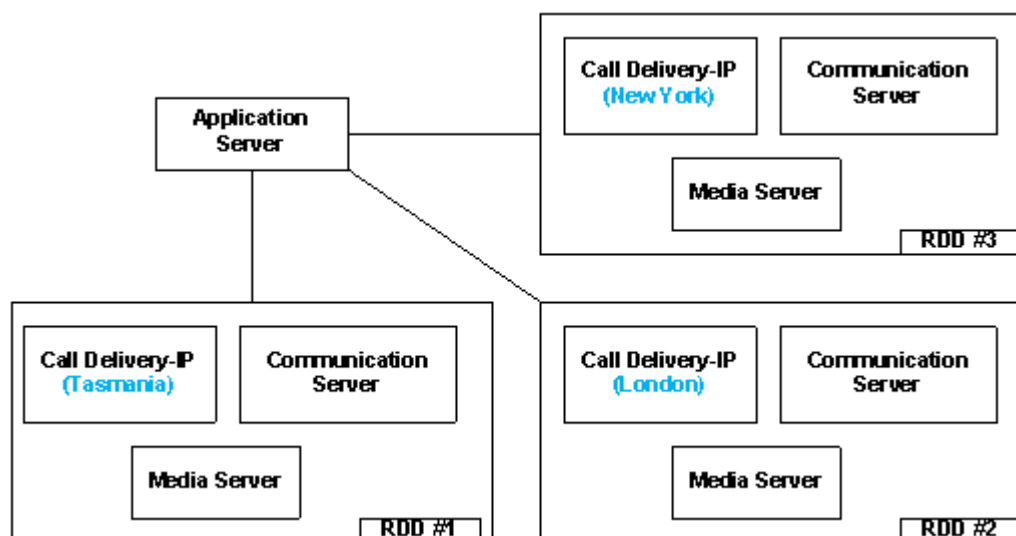
By assigning targets to specific Call Delivery components, the physical location of the recording can be controlled. In addition, the loads on each Call Delivery can be minimized. By default, when no location attributes are set, Call Delivery tracks all targets. In systems with large numbers of targets, this can affect the performance of SmartTAP.

### Assign a Location Attribute to each Call Delivery Component

Each Call Delivery instance must be manually assigned a value, which is generally referred to as a location attribute, although it does not technically have to refer to a location. The location attribute should be something meaningful within the system topology, which is often a location.

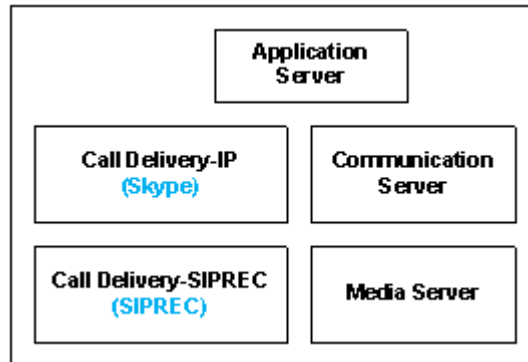
In the first example below, there are three Remote Data Delivery (RDD) installations, all managed by a central Application server. Each Call Delivery in the RDD is assigned a location attribute: "Tasmania", "London", and "New York".

Figure 10-2: Location Attribute for each Call Delivery Component



In the second example below, there are two different Call Delivery components installed on the same server. Their “location attribute” references the intended functionality rather than a physical location. In this case, One Call Delivery handles “Skype” targets and the other handles “SIPREC” targets.

**Figure 10-3: Skype and SIPREC Targets**



In the case of SmartTAP systems configured in the active/active mode, where Call Delivery components are organized into pairs for redundancy, both components in the pair must share the same location attribute value.

The location attribute must be set manually for each Call Delivery instance. This value is not displayed in the SmartTAP GUI.

➤ **Do the following:**

1. Stop the Call Delivery service(s) in the service manager.
2. Open the calldeliveryconfig.xml file for editing. By default, the configuration file is located in “C:\Program Files (x86)\AudioCodes\SmartTAP\CD-xx\config\calldeliveryconfig.xml”, where xx represents which type of Call Delivery was installed.

Within this file is an XML element called <targeting>:

```

<targeting>
  <attributes>
  </attributes>
  <targetConversions>
    <converter format="2" regex="(sips?:)?(?:[^\@]*)@.*?"
type="SIP_URI"></converter>
    <converter format="1" regex="(d+)" type="TRUNK_ID"></converter>
    <converter format="5" regex="(tel:)?(\+?)(d+)(;ext=)(d+)"
type="EXTENSION"></converter>
    <converter format="2" regex="^(+?)(d+)"
type="EXTENSION"></converter>
    <converter regex="(tel:)?(\+?)(d+)(;ext=)(d+)" type="TEL_URI">
      <target format="3" />
      <target format="5" />
      <target format="3\4\5" />
    </converter>
  </targetConversions>
</targeting>
  
```



```
</converter>
  <converter format="\3" regex="^(tel:)?(\+?)(\d+)$"
type="TEL_URI"></converter>
  </targetConversions>
</targeting>
```

If no location attribute has been set, then you will see that the <attributes> element is empty, as shown above. The <targetConversions> element is not relevant for the purposes of setting a location attribute.

Add a new entry in the <attributes> element as shown. From the first example, the first RDD has a location attribute with the value of “Tasmania”, so that is what is shown in the example.

```
<targeting>
  <attributes>
    <attribute name="Location">
      <value>Tasmania</value>
    </attribute>
  </attributes>
```

The attribute name should be set as “Location”. This is a convention that makes it easier to understand what is being configured and how to troubleshoot it. The attribute name can have any value, though it must be at least one character long.

Call Delivery can support multiple <attribute> elements under the <attributes> element and multiple <value> elements under each <attribute>. However, the use cases for doing so are extremely rare.

The entries for the attribute name and <value> are case-sensitive, so it is important to make a note of exactly how they were entered into the configuration file. These values will be needed again in a later step.

Once the location attribute is set up, save the configuration file and use the Service Manager to start up the Call Delivery component. Remember to do this for each Call Delivery within the SmartTAP system.



Multiple Call Delivery components can use the same location attribute value. This means that targets that match this value will be tracked by multiple Call Delivery components. This is another example of a rare use case.

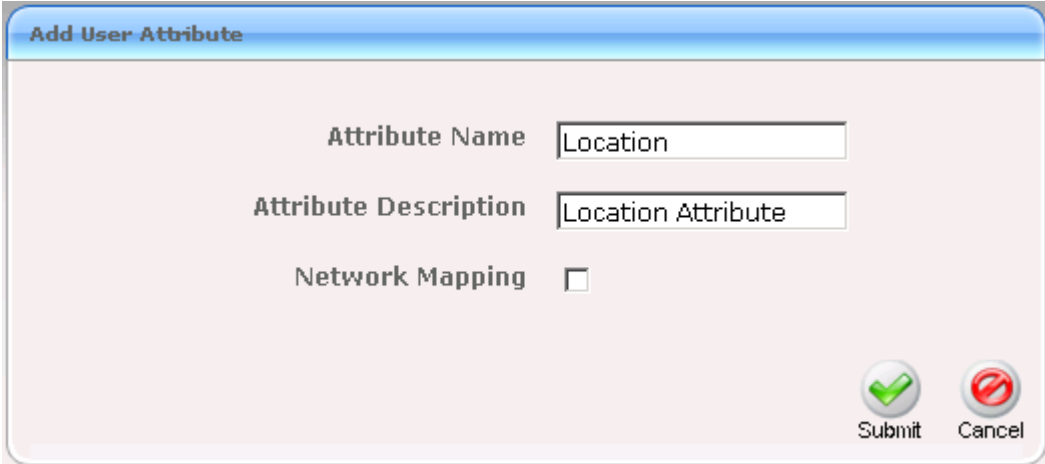
## Create a Location Attribute in the SmartTAP GUI

To assign a location to each target, a new attribute must be created. Attributes are a way to assign meta-data to each targeted user or device. In this case, we are creating an attribute that Call Delivery will specifically look at in order to match its location attribute with the targets’.

➤ **To create a Location Attribute for a user:**

1. Click Users > User Management > Add User Attribute

**Figure 10-4: Add User Attribute**



2. For the “Attribute Name” enter “Location”. If you decided to use a different attribute name in the Call Delivery configuration file, then enter that name here instead. You must enter the value exactly as it appears in the Call Delivery configuration file.
3. Enter a useful description under “Attribute Description”. This field does not need to match any specific value.
4. Leave the “Network Mapping” checkbox unchecked.
5. Click Submit to add the new user attribute.



If there are devices targeted in addition to (or instead of) users, then create the same attribute under Users > Device Management > Add Device Attribute. User attributes and Device attributes do not conflict with each other, therefore they can use the same “Attribute Name”.

## Assign a Location to Each User/Device in the SmartTAP GUI

The last step is to assign a location to each user and/or device that is targeted for recording. The idea is to associate each target with a specific Call Delivery.

Below is an example of adding a new user and setting its location attribute at the same time. To add a user, click on “User” -> “User Management” -> “Add User”. Following the first example, by setting the “location” field to “Tasmania” as shown below, this new user will only be tracked by RDD #1. RDD #2 and RDD #3 will disregard this user because its location attribute doesn’t match what was configured in the Call Delivery configuration file.

Figure 10-5: Add User

**Add User**

First Name: 
 Last Name:

Email: 
 Login Id:

Id / Alias: 
 Extension:

**Location:** 
 TelNo:

UserName: 
 Retention Policy:

Recording Profile: 
 Legal Hold: OFF

**Security Profiles**

**Groups**

➤ **To update the location attribute for existing users:**

1. Click **Users > User Management > View/Modify Users**.
2. Click the “pencil” icon in the “Modify” column for the user you wish to edit. Enter the location attribute value in the “Location” field similar to the screen above.



The procedures for setting up Devices and for setting up Users are identical.

When SmartTAP is configured to map its users and their attributes from the Active Directory, the SmartTAP location attribute can be mapped to the LDAP attribute that holds the appropriate location information through the SmartTAP LDAP Configuration page.

Figure 10-6: SmartTAP LDAP Configuration page

Once the location attribute has been set/changed and submitted, each Call Delivery component is updated with the new targeting information. For those Call Delivery components that have a location attribute set, they will ignore any target that does not precisely match their location attribute.

## Verify the Target List in Each Call Delivery

It is possible to optionally check to make sure that each Call Delivery component has been updated with the intended target list. Open the file call TargetList.xml. By default, the file is located in “C:\Program Files (x86)\AudioCodes\SmartTAP\CD-xx\TargetList.xml”, where xx represents the type of installed Call Delivery instance.



Be sure not to edit or save this file as its ‘read only’.

The following is an example of the contents of the file:

```
<?xml version="1.0" encoding="UTF-8" standalone="no" ?>
<targeting>
  <version>2</version>
  <targets>
    <target caselid="105" mediaType="15" targetIndex="531" type="CALLSTRING"
value="johns"></target>
  </targets>
</targeting>
```

In this example, John Smith is targeted by his user name, which was configured to “JohnS”. This value is found in the TargetList.xml file, if the user’s location attribute matches the equivalent entry in the Call Delivery configuration file. For example, John has the location attribute ‘New York’ and there is a CD with the location attribute ‘New York’. Target attributes are not case-sensitive so the value appears as lowercase “johns” in the TargetList.xml file. You may need to wait up to one minute for the file to be updated after setting the location attribute in the SmartTAP 360° Live GUI.

If the expected target is not present in this file, double-check the location attribute value in the Call Delivery configuration file and in the SmartTAP 360° Live Web interface. Both the attribute name and its value are case-sensitive. The user or device may also fail to appear in the list if it is not targeted for other reasons, such as a lack of licenses or missing targeting attributes.

## CD-SIPREC Configuration

The CdSipRecConfig.xml configuration file is displayed as follows:

```
<SipRecStack>
<Listen IP="127.0.0.1" UDP="5068" />
<!--> NoLicenseRejectMsg - Reject message in case no licenses are available <-->
<!--> NotTargetedRejectMsg - Reject message for untargeted calls (200Ok with
a=inactive) <-->
<SRS ExtSysCallIdHeader="x-audc-call-id" NoLicenseRejectMsg="486"
NotTargetedRejectMsg="200"/>
</SipRecStack>
```

### ■ CD-SIPREC Behavior:

- Available Licenses will be checked for incoming call:
  - ◆ CD-SIPREC will reject the call with the configured 'NoLicenseRejectMsg' status code or with the default '486 Busy Here' if the configured code is not valid.
- Regarding calls without any targeted participant, the call will be rejected with 'NormalRejectMsg' OR with 200OK(a=inactive) if the code is not valid, in which case CD will keep the call and record a possible transfer to a targeted user.
- In case None of the CDs have an available license, the call will be rejected by all CDs and multiple alarms will be sent to ST.



'NotTargetedRejectMsg' should be configured to a different reject message than the one configured in the SBC ('Alternative Reason') Note the following regarding the SBC configuration:

- The SBC should support Load Balancing between a group of SRSs (Session Recording Servers)
- A 'rule' to refer a call to another SRS (in the list) can be configured, it is the 'Alternative Reason' I mentioned, in our case it is a custom reject message and should match the one configured in 'NoLicenseRejectMsg'.

### ■ CD-SIPREC supports parsing of external custom headers that are found in the SDP and use them as the call's SysCallId.

- ExtSysCallIdHeader – Configurable external header that will be parsed and used as SysCallId (Original call ID), SBC configuration is also required.

### Example

```
INVITE sip:[field1]@[remote_ip]:[remote_port] SIP/2.0
Via: SIP/2.0/[transport] [local_ip]:[local_port];branch=[branch]
From: sipp <sip:[field0]@[local_ip]:[local_port]>;tag=[call_number]
To: sut <sip:[field1]@[remote_ip]:[remote_port]>
Call-ID: [call_id]
CSeq: 1 INVITE
Contact: sip:sipp@[local_ip]:[local_port]
Max-Forwards: 70
Subject: Performance Test
Content-Type: multipart/mixed; boundary=unique-boundary-1
Content-Length: [len]
x-audc-call-id: 545362a9-4cb3-4a55-85b8-b33ca83a6517
```



The x-audc-call-id header will be parsed and the 545362a9-4cb3-4a55-85b8-b33ca83a6517 value will be the sysCallId that is displayed in the User Interface.

## CD-SIPREC Support in TLS Transport

CD-SIPREC uses the Certificate and the Private Key to maintain a secured, encrypted connection with the SRC (SBC). In case a certificate-chain is used, all the certificates in the chain MUST be stored in one of the 'Trusted Root Certification Authorities' or 'Intermediate Certification Authorities' certificate stores on the CD-SIPREC platform. CD-SIPREC imports the certificates that are found in these stores into its local store. You can also provide a path to the CA certificates folder and CD then loads the certificate files from this location. You can generate the certificates automatically based on the Common Name 'TLSCertCN' or manually from the CertPEMFile\KeyPEMFile:

- [Generating Certificates Automatically](#) below
- [Generating Certificates Manually](#) on page 182



- Load a matching certificate to the SRC (SBC) that is signed by the same Trusted Root CA.
- Configure a matching port on both the SRC (SBC) and the CD-SIPREC for securing TLS communication.

## Generating Certificates Automatically

This section describes how to generate certificate files automatically based on the Common Name TLSCertCN.



TLS transport is associated with only one Certificate and PrivateKey i.e. the TLSCertCN, therefore ensure that the PEM files CertPEM and KeyPEM files are empty or deleted in the CdSipRecConfig.xml file.

➤ **Do the following:**

1. Open the CdSipRecConfig.xml file.
2. Configure the following:

```
<Listen
IP="0.0.0.0"
TLS="5069"
SSLType="SSLv23"
TLSVerificationMode="None"
TLSCertCN="AudcTLS"
/>
```

Where "AudcTLS" is an example Common Name.



Multiple transports can be configured (UDP\TCP\TLS), for example:

```
<SipRecStack> <Listen IP="0.0.0.0" UDP="5068"/> <Listen IP="0.0.0.0" TLS="5069"
.....<params>..... /> <Listen ... <Listen ... </SipRecStack>
```

3. Configure SSLType transport type to one of the following:
  - "NoSSL"
  - "TLSv1" for TLS 1.0 version
  - "SSLv23" for TLS 1.2 and above.
4. Configure TLSVerificationMode (Certificate verification as a part of the TLS handshake) to one of the following:
  - "None"
  - "Optional": certificate verification will be performed only when requested
  - "Mandatory": verification will always be performed
5. Configure TLSCertCN – a Certificate CommonName that is imported and used for the TLS transport.

CD-SIPREC searches for the certificate in the Local Machine's Personal certificate store. If the store cannot be accessed, CD searches in Current User's Personal store instead.



The certificate **MUST** contain an exportable Private Key.

## Generating Certificates Manually

This procedure describes how to generate certificates manually using the CertPEM and KeyPEM files.



TLS transport is associated with only one Certificate and PrivateKey, therefore ensure that the TLSCertCN entry is empty or deleted in the CdSipRecConfig.xml file.

### ➤ Do the following:

1. Open the CdSipRecConfig.xml file.
2. Configure the following:

```
<Listen
IP="0.0.0.0"
TLS="5069"
SSLType="SSLv23"
TLSVerificationMode="None"
CertPEMFile=".....\<Path>\cert.pem"
KeyPEMFile= ".....\<Path>\key.pem"
CADir="....\<Path>\Certificates\CA\"
/>
```

Where <Path> is the location of the certificate files on the local machine.



Multiple transports can be configured (UDP\TCP\TLS), for example:

```
<SipRecStack> <Listen IP="0.0.0.0" UDP="5068"/> <Listen IP="0.0.0.0" TLS="5069"
.....<params> ..... /> <Listen ... <Listen ... </SipRecStack>
```

3. Configure SSLType transport type to one of the following:
  - "NoSSL"
  - "TLSv1" for TLS 1.0 version
  - "SSLv23" for TLS 1.2 and above.
4. Configure TLSVerificationMode (Certificate verification as a part of the TLS handshake) to one of the following:
  - "None"
  - "Optional": certificate verification will be performed only when requested
  - "Mandatory": verification will always be performed
5. Configure CertPEMFile- the path to .pem certificate file to be used for the TLS transport.
6. Configure KeyPEMFile - the path to .pem PrivateKey file to be used for the TLS transport.





These files must NOT be protected with a password(PassPhrase).

7. Configure CAdir - path to CA certificates that is loaded into CD's local store (for chain certificates).

Delete this text and replace it with your own content.

## Example for Creating a Self-Signed Certificate for CD-SIPREC and SBC Connection

This section describes how to create a Self-Signed Certificate for CD-SIPREC and SBC Connection. Perform the following procedures:

1. [Create a Certificate Signing Request \(CSR\)](#) below
2. [Sign the Certificate at the Certificate Authority \(CA\)](#) on the next page
3. [Import Certificate to CD-SIPREC Certificate Store](#) on the next page

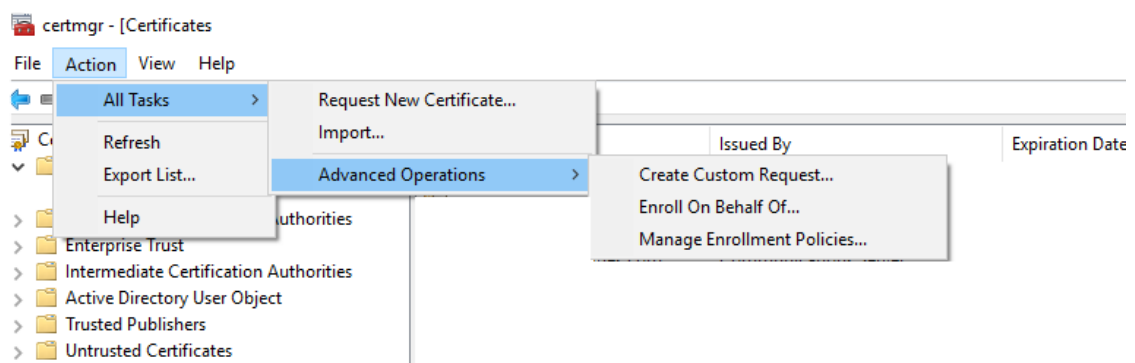
### Create a Certificate Signing Request (CSR)

This section describes how to create a Self-Signed certificate for the TLS connection between the Call Delivery server and the SBC.

#### ➤ Do the following:

1. Enter the Local Machine's certificate store (**Action > All Tasks > Advanced Operations > Create Custom Request**).

Figure 10-7: Create Custom Request



2. Click **Next** on 'Select Certificate Enrollment Policy'.
3. Click **Details** and then **Properties**.
4. In **General** tab, enter **Friendly Name**, for example "AudcTLS"
5. In **Subject** tab, choose 'Common name' from the drop-down list and **Add** a value:

Figure 10-8: Certificate Properties

**Certificate Properties** [X]

General | **Subject** | Extensions | Private Key

The subject of a certificate is the user or computer to which the certificate is issued. You can enter information about the types of subject name and alternative name values that can be used in a certificate.

**Subject of certificate**  
The user or computer that is receiving the certificate

**Subject name:**

Type:		
Common name	Add >	CN=AudcTLS
Value:	< Remove	
AudcTLS		

6. In **Private Key** tab, check “Make private key exportable”.
7. Click **Apply** > **Next**.
8. Choose a file name\directory and save the certificate request.

### Sign the Certificate at the Certificate Authority (CA)



Ensure that the Certificate is appropriately signed by the Certificate Authority (CA).

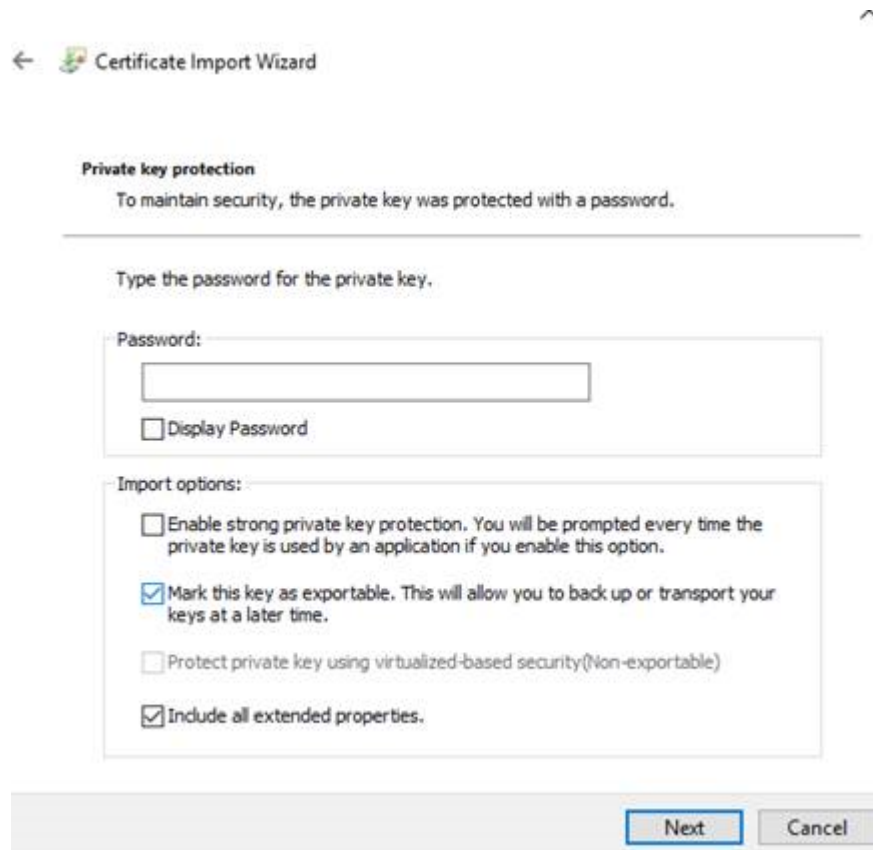
### Import Certificate to CD-SIPREC Certificate Store

This section describes how to import the newly generated certificate to the CD-SIPREC Certificate Store.

#### ➤ To import the certificate to the Certificate Store:

1. Return to the Local Machine’s certificate store (**Action** > **All Tasks** > **Import**).
2. Enter the certificate’s path and click **Next**.
3. Under ‘Import Options’, check “Mark this key as exportable...” and click **Next**.

Figure 10-9: Certificate Import Wizard



The screenshot shows the 'Certificate Import Wizard' window. At the top, there is a back arrow and the title 'Certificate Import Wizard'. Below the title, the section 'Private key protection' is displayed. It contains the text: 'To maintain security, the private key was protected with a password.' A horizontal line separates this text from the next section. Below the line, it says 'Type the password for the private key.' There is a 'Password:' label followed by a text input field. Below the input field is a checkbox labeled 'Display Password'. Below this is another section titled 'Import options:' which contains four checkboxes with their respective descriptions: 'Enable strong private key protection. You will be prompted every time the private key is used by an application if you enable this option.' (unchecked), 'Mark this key as exportable. This will allow you to back up or transport your keys at a later time.' (checked), 'Protect private key using virtualized-based security(Non-exportable)' (unchecked), and 'Include all extended properties.' (checked). At the bottom right of the window, there are two buttons: 'Next' and 'Cancel'.

4. Choose 'Place all certificates in the following store', select **Personal** store and click **Next > Finish**.
5. Try to export the certificate's and validate that the Private Key is exportable.

# 11 Backup and Restore

This chapter describes the backup and restore procedures.

## Prerequisites

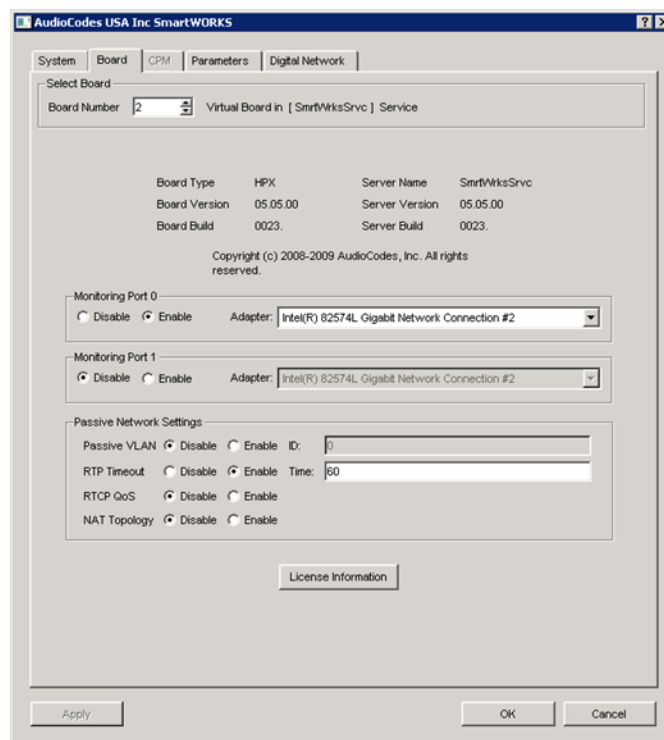
This section describes actions that you need to perform before running backup and restore procedures.

### ➤ Do the following:

1. Go to the control panel and run SmartCONTROL.
2. Make note of the configuration of the Board tab, take screen shots if necessary.



**Figure 11-1: Board Tab Configuration**



3. Run services.msc (Start->Run->type "services.msc" enter), and stop all SmartTAP 360° Live services.
  - AudioCodes AS (SmartTAP Server)
  - AudioCodes CS (SmartTAP Server)
  - AudioCodes MS (SmartTAP Server)
  - AudioCodes MS-TR (SmartTAP Server)
  - AudioCodes CD-XX (SmartTAP Server)
  - AudioCodes MD (Skype for Business Edge, Mediation or Conference Server)

- AudioCodes AN (SmartTAP AN Server)
- AudioCodes MP (SmartTAP MP Server)
- AudioCodes Skype for Business plug-In (Skype for Business FE or SBA)
- MySQL (SmartTAP 360° Live Server)
- SmartWORKS Service (SmartTAP , Edge, Mediation or Conference Server)

## Backup

This section describes how to backup the data location for each of the following SmartTAP components from the command prompt:

- Call Delivery Service (see [Call Delivery Service](#) below)
- Media Service (see [Media Service](#) on the next page )
- Media Delivery Service: Installed on Skype for Business Edge, Mediation or Conference Server (see [Media Delivery Service: Installed on Skype for Business Edge, Mediation or Conference Server](#) on the next page )
- Communication Service (see [Communication Service](#) on the next page )
- Application Service (see [Application Service](#) on page 189)
- Database (see Section [Database](#) on page 189 )
- SmartTAP Skype for Business Plug-in (FE, SBS, SBA) (see [SmartTAP 360° Live Skype for Business Plug-in \(FE, SBS, SBA\)](#) on page 190)
- SmartTAP Announcement Server (see [SmartTAP 360° Live Announcement Server](#) on page 62)
- SmartTAP Media Proxy (see [SmartTAP 360° Live Media Proxy](#) on page 190)



It is recommended to perform a full backup for all servers running SmartTAP components according to the organization hosting SmartTAP backup/restore policies. The procedures above only instruct how to specifically back up the data components for each server.

## Call Delivery Service

**Table 11-1: Backup - Call Delivery Service**

Configuration	Path	... \AudioCodes\SmartTAP\CD-XX\
	Instructions	Copy ... \AudioCodes\SmartTAP\CD-XX\Config to \$backup_dir\CD-XX\

Logs	Path	...\AudioCodes\SmartTAP\CD-XX\
	Instructions	Copy ...\AudioCodes\SmartTAP\CD-XX\Logs to \$backup_dir\CD-XX\



Replace XX with IP, DS or AL depending upon the type of CallDelivery service installed. The SmartTAP server must be added to the Domain.

## Media Service

**Table 11-2: Backup - Media Service**

Configuration	Path	...\AudioCodes\SmartTAP\MS\Server\
	Instructions	Copy ...\AudioCodes\SmartTAP\MS\Server\bin\ac-hmp20.ini to \$backup_dir\MS\Server\bin\
Logs	Path	...\AudioCodes\SmartTAP\MS \
	Instructions	Copy ...\AudioCodes\SmartTAP\MS\Log to \$backup_dir\MS\

## Media Delivery Service: Installed on Skype for Business Edge, Mediation or Conference Server

**Table 11-3: Backup - Media Delivery Service**

Configuration	Path	...\AudioCodes\SmartTAP\MD\Config\
	Instructions	Copy ...\AudioCodes\SmartTAP\MD\Config\ to \$backup_dir\MD\
Logs	Path	...\AudioCodes\SmartTAP\MD \
	Instructions	Copy ...\AudioCodes\SmartTAP\MD\Logs to \$backup_dir\MD\

## Communication Service

**Table 11-4: Backup - Communication Service**

Configuration	Path	...\AudioCodes\SmartTAP\CS\bin\
	Instructions	Copy ...\AudioCodes\SmartTAP\CS\bin\service.bat to \$backup_dir\CS\bin\

Logs	Path	... \AudioCodes\SmartTAP\CS \Server\NGP\
	Instructions	Copy ... \AudioCodes\SmartTAP\CS\Server\NGP\Log to \$backup_dir\CS\Server\NGP\

## Application Service

**Table 11-5: Backup - Application Service**

Configuration	Path	... \AudioCodes\SmartTAP\AS\bin\
	Instructions	Copy ... \AudioCodes\SmartTAP\AS\bin\service.bat to \$backup_dir\AS\bin\
Logs	Path	... \AudioCodes\SmartTAP\AS\standalone\
	Instructions	Copy ... \AudioCodes\SmartTAP\AS\standalone\log to \$backup_dir\AS\standalone\

## Database

**Table 11-6: Backup - Database**

\*MySQL dir is MySQL\MySQL Server 8.0

Configuration	Path	... \MySQL\MySQL Server 8.0\
	Instructions	Stop SmartTAP AS & MySQL service Copy ... \MySQL\MySQL Server 8.0\data directory to \$backup_dir\ MySQL_PF\MySQL Server 8.0\
	Path	C:\ProgramData\MySQL\
	Instructions	Copy C:\ProgramData\MySQL\MySQL Server 8.0 directory to \$backup\MySQL_PD\ Start MySQL & SmartTAP AS service

## SmartTAP 360° Live Skype for Business Plug-in (FE, SBS, SBA)

**Table 11-7: SmartTAP 360° Live Skype for Business Plug-in (FE, SBS, SBA)**

Configuration	Path	...\AudioCodes\SmartTAP\SmartTAP Lync Client\
	Instructions	Copy ...\AudioCodes\SmartTAP\SmartTAP Lync Client\ SmartTapLyncSvc.exe.config to \$backup_dir\SmartTAP Lync Client\FE#\
Logs	Path	...\AudioCodes\SmartTAP\SmartTAP Lync Client\
	Instructions	Copy ...\AudioCodes\SmartTAP\SmartTAP Lync Client\Logs to \$backup_dir\SmartTAP Lync Client\



Replace # in instructions above to the actual ID # of the FE server. Repeat above instructions for each FE in Pool.

## SmartTAP 360° Live Announcement Server

**Table 11-8: Backup - SmartTAP 360° Live Announcement Server**

Configuration	Path	...\AudioCodes\SmartTAP\AN\Config
	Instructions	Copy Config folder to \$backup_dir\AN\
Logs	Path	...\AudioCodes\SmartTAP\AN\Logs
	Instructions	Copy Log folder to \$backup_dir\AN\

## SmartTAP 360° Live Media Proxy

**Table 11-9: Backup - SmartTAP 360° Live Media Proxy**

Configuration	Path	...\AudioCodes\SmartTAP\MP\Config
	Instructions	Copy Config folder to \$backup_dir\AN\
Logs	Path	...\AudioCodes\SmartTAP\MP\Logs
	Instructions	Copy Log folder to \$backup_dir\AN\

### Media

Copy the directory structure and media files from the path defined in the SmartTAP Web interface (See example screen below). Make sure you retain the same directory structure when



backing up media to the backup location. We recommend that you save the screen capture of the recording location to retain your Media file settings.

**Figure 11-2: Add Recording Location**

### System Profile Tool

The System Profile Tool provides a convenient method to capture all the log files for the SmartTAP 360° Live services on a specific server.

**Table 11-10: System Profile Tool**

Configuration	Path	... \AUDIOCODES \Tools \
	Instructions	<ul style="list-style-type: none"> <li>■ Go to the command prompt</li> <li>■ Run SystemProfile.exe</li> <li>■ The system_profile.exe tool will automatically run and capture the results to the SystemProfile.zip file in the same folder</li> </ul> <div style="border: 1px solid gray; padding: 5px; margin-top: 10px;">  Before you run a test, you must go to the folder of the SmartTAP 360° Live service and set the appropriate log level                 </div>

### Restore

This section describes how to restore the SmartTAP 360° Live components.

➤ **To restore the SmartTAP 360° Live components:**

1. Install SmartTAP 360° Live on the new server.
2. Run services.msc (**Start > Run >** type “services.msc” enter), and stop all SmartTAP 360° Live services.



You MUST restore to the same version of SmartTAP 360° Live that was backed up (with the same major and minor versions).

This section describes how to restore the following components:

- Call Delivery Service (see [Call Delivery Service](#) on page 187 )
- Media Service (see [Media Service](#) on page 188)
- Media Delivery Service (see [Media Delivery Service](#) on the next page )
- Database (see [Database](#) on page 189 )
- SmartTAP 360° Live Skype for Business Plug-in (FE, SBS, SBA) (see [SmartTAP 360° Live Skype for Business Plug-in \(FE, SBS, SBA\)](#) on page 190
- Announcement Server (see [Announcement Server \(AN\)](#) on page 68 )
- Media Proxy (see [Media Proxy](#) on page 194 )
- Media (see [Restoring Media](#) on page 194 )

## Call Delivery Service

**Table 11-11:Restore – Call Delivery Service**

Configuration	Path	... \AudioCodes\SmartTAP\CD-XX\
	Instructions	Rename ... \AUDIOCODES\SmartTAP\CD-XX\Config to Config.orig  Copy \$backup_dir\CD_XX\Config to ... \AUDIOCODES\SmartTAP\CD-XX\



Replace XX with IP, DS or AL depending upon the type of CallDelivery service installed.

## Media Service

**Table 11-12:Restore – Media Service**

Configuration	Path	... \AudioCodes\SmartTAP\MS\Server\bin\
	Instructions	Rename ... \AUDIOCODES\SmartTAP\MS\Server\bin\ac-hmp20.ini to ac-hmp20_orig.ini  Copy \$backup_dir\MS\Server\bin\ac-hmp20.ini to ... \AUDIOCODES\SmartTAP\MS\Server\bin\

## Media Delivery Service

**Table 11-13:Restore – Media Delivery Service**

Configuration	Path	...\AudioCodes\SmartTAP\MD\
	Instructions	Rename ... \AudioCodes\SmartTAP\MD\Config\ folder to \Config.orig  Copy \$backup_dir\MD\Config to ...\AudioCodes\SmartTAP\MD\

## Database

**Table 11-14:Restore – Database**

Configuration	Path	...\MySQL\MySQL Server 8.0\
	Instructions	Stop SmartTAP AS service Stop MySQL service Rename ... \MySQL\MySQL Server 8.0\data directory to data.orig Copy \$backup_dir\ MySQL\MySQL Server 8.0\data directory to ... \MySQL\MySQL Server 5.6\
	Path	C:\ProgramData\MySQL\
	Instructions	Rename C:\ProgramData\MySQL\MySQL Server 8.0 directory to MySQL Server 8.0.orig Copy \$backup_dir\MySQL_PD\MySQL Server 8.0 directory to C:\ProgramData\MySQL\ Start MySQL service Start SmartTAP AS service

## SmartTAP 360° Live Skype for Business Plug-in (FE, SBS, SBA)

This step is only required if the FE, SBS or SBA was rebuilt

**Table 11-15:Restore – SmartTAP 360° Live Skype for Business Plug-in (FE, SBS, SBA)**

Configuration	Path	...\AudioCodes\SmartTAP\Lync Plug-in\
	Instructions	Copy \$backup_dir\ Lync Plug- in\\FE#\LyncPlugIn.exe.config to ...\AudioCodes\SmartTAP\Lync Plug-in\



Replace # in instructions above to the actual ID # of the FE server. Repeat above instructions for each FE in Pool.

## Announcement Server

**Table 11-16:Restore – Announcement Server**

Configuration	Path	... \AudioCodes\SmartTAP\AN\
	Instructions	Rename ... \AudioCodes\SmartTAP\AN\Config\ folder to \Config.orig Copy \$backup_dir\AN\Config to ... \AudioCodes\SmartTAP\AN\

## Media Proxy

**Table 11-17:Restore – Media Proxy**

Configuration	Path	... \AudioCodes\SmartTAP\MP\
	Instructions	Rename ... \AudioCodes\SmartTAP\MP\Config\ folder to \Config.orig Copy \$backup_dir\MP\Config to ... \AudioCodes\SmartTAP\MP\

## Restoring Media

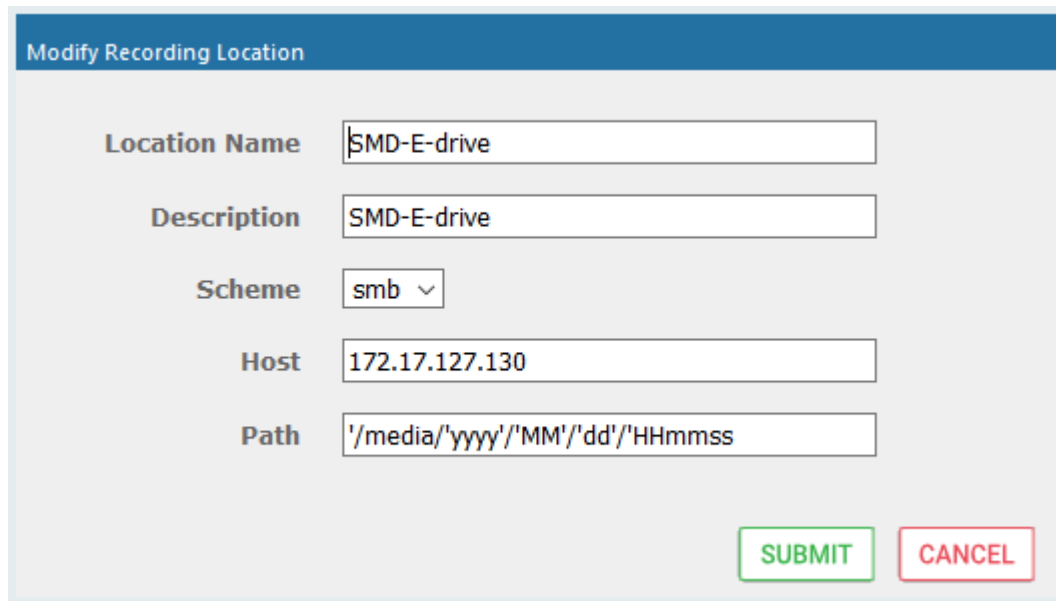
This section describes how to restore media.

### ➤ To restore media:

1. Copy the directory structure and media files from the path defined in the SmartTAP 360° Live Web interface (See example screen below).

Make sure you retain the same directory structure when backing up media to the backup location. We recommend that you save the screen capture of the recording location to retain your Media file settings.

Figure 11-3: Add Recording Location



Modify Recording Location

Location Name

Description

Scheme

Host

Path



- Its recommended to define the SMB Scheme host machine with an FQDN instead of an IP address. This prevents situations where the System administrator changes the IP address of the SmartTAP 360° Live application server and as a consequence, the media files can no longer be accessed.
- If you define the media location in a different domain to the SmartTAP 360° Live AS, ensure that write permissions are set for the directory to which you wish to save the media files.

2. Reboot the SmartTAP 360° Live machine
3. Check SmartTAP 360° Live board info using SmartCONTROL, compared with saved board info screen shots if necessary
4. System should be restored and functioning. Verify you can play old calls and that the system can record new calls.

## 12 Troubleshooting

This chapter is for technical personnel who are responsible for the installation and maintenance of the SmartTAP 360° Live product.

- The AudioCodes support team may refer to the sections in the troubleshooting chapter of this document when assisting customers to resolve technical issues pertaining to the SmartTAP 360° Live product.
- This chapter provides the most common troubleshooting information and procedures; however, does not preclude the need for the customer to contact the AudioCodes support group for further assistance.

### How To Validate Port Mirror for Recording Skype for Business Calls

- This section provides a procedure to verify that a proposed or existing SPAN/RSPAN/Mirrored port location (also referred to as the tapping location) meets the SmartTAP recording requirements for Skype for Business.
- The document is not intended as a tutorial. It is assumed that the personnel involved in this activity will be able to examine a basic SIP call flow, to configure SPAN/RSPAN Mirroring on the switches/routers, and to administer the Skype for Business servers.

#### Prerequisites

The following tools and Administrative privileges are required to perform the procedure in this document:

- Wireshark or IP sniffer tool on SmartTAP 360° Live server or Testing PC
- Access to Skype for Business server to enable and collect logs
- Access to IP Switch/Router to configure port SPAN/MIRROR
- Ability to place test calls

#### Introduction: SmartTAP Recording Concepts

The SmartTAP recorder relies on a Microsoft Certified Skype for Business plugin to process the call signaling and on the availability of the MEDIA for the call at the recording NIC interface(s).

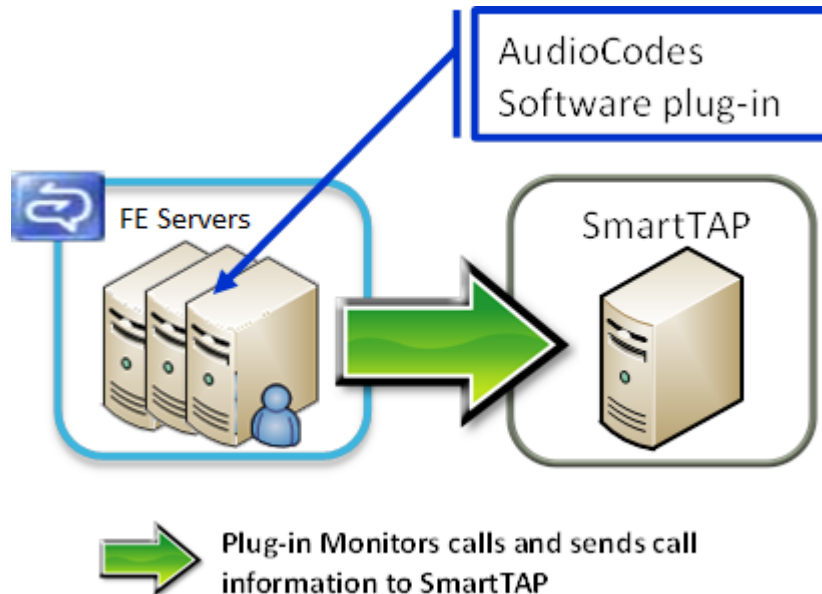
The Skype for Business plugin resides on the Front End Server(s) and provides the call details to the SmartTAP recorder which records the MEDIA for the call through the recording NIC interface.

#### SmartTAP 360° Live Processing of Skype for Business Signaling

The SmartTAP 360° Live Skype for Business recorder requires the installation of a plugin for every Skype for Business server that is involved in call forwarding/routing decisions. Typically,

these are the (FES) Front End Servers; however, could also be a (SBS) Small Business Server, or a (SBA) Survivable Branch Appliance. The SmartTAP 360° Live plugin is responsible for collecting the call information (signaling) and sending it to the SmartTAP 360° Live recorder as shown in the figure below.

**Figure 12-1: AudioCodes Software Plugin**

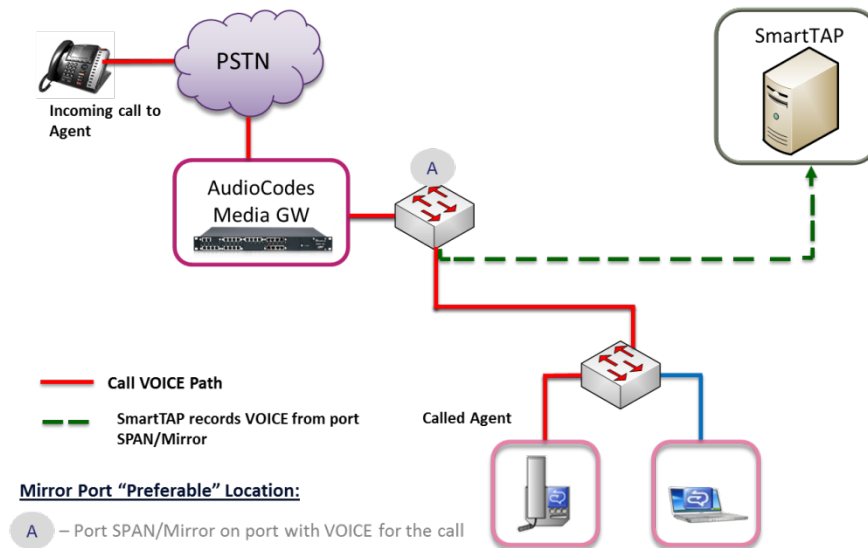


Whether the SmartTAP 360° Live Skype for Business plugin is installed, the Skype for Business Administrator has access to logging facilities that enables the logging of SIP signaling and saving these logs to a text file. This log file contains the Skype for Business call information and the MEDIA information that correlates with the call information that the plugin sends to the SmartTAP 360° Live recorder.

### SmartTAP 360° Live Media Processing

The SmartTAP 360° Live recorder uses the call information received through the plugin to locate the MEDIA associated with the call to record. The MEDIA to record MUST appear on the recording NIC interface (or interfaces if two recording NICs are used). The recording NIC interface is connected to the switch/router interface that forwards the mirrored data.

Figure 12-2: SmartTAP 360° Live Media Processing



## Procedure

This procedure includes a step-by-step sequence to guide the user from the setup of Skype for Business and network environment, gathering of data, and finally to the analysis of the data collected.

### Setup Skype for Business Logging

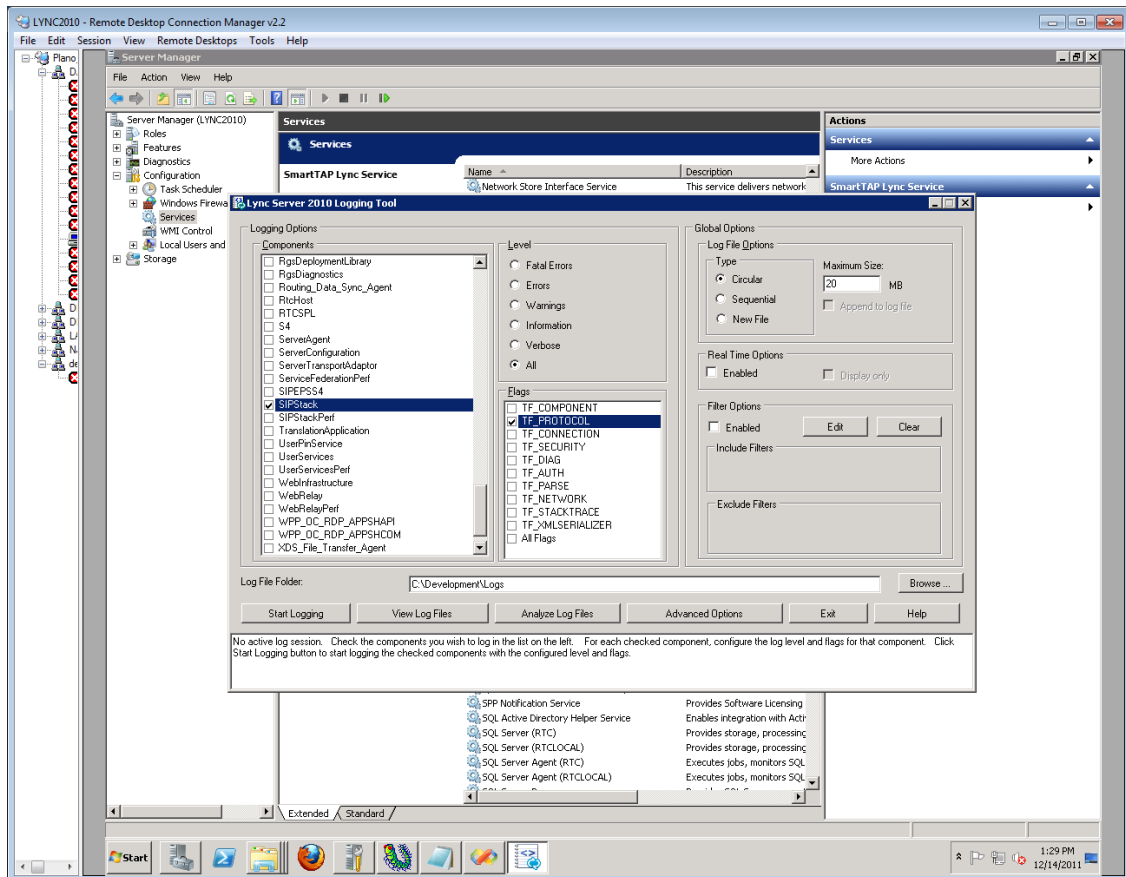
This section describes how to setup Skype for Business Logging.

#### ➤ To setup Skype for Business Logging:

1. Log in to the server (FES, SBS, or SBA) as user with Administrative privileges.
2. Open the Lync Server Logging Tool:
  - Start > All Programs > Microsoft Lync Server 2010 > Lync Server Logging Tool
3. In the Components list, select **SIPStack only**.
4. In the Flags list, select **TF\_PROTOCOL only**.
5. In the Level, select **All**.



Figure 12-3: Skype for Business Logging



## Setup Sniffer

This section describes how to setup the sniffer.

### ➤ To setup the sniffer:

1. Log into the test PC (or SmartTAP 360° Live Server).
2. Start the sniffer software (Wireshark).
3. Select the recording NIC interface to monitor.

## Capture a Test Call

This section describes how to capture a test call.

### ➤ To capture a test call:

1. On the Skype for Business server click “Start Logging” button.
2. On the test PC click “Start” to start capturing traffic.
3. Place a Skype for Business test call.
4. On the Skype for Business server click “Stop Logging” button.
5. Click “Analyze” and “Browse” to save the log file.

6. On the test PC click “Stop” to stop capturing traffic.
7. Save the capture (File -> Save As...).

## Analysis

To verify that the MEDIA for the test call is present on the sniffer log, you must first find the signaling for the test call in the Skype for Business log. Once you have found the test call signaling, you must extract the MEDIA information for the call and then examine the sniffer log and see if in fact there was traffic present on the recorded IP and PORT.

### Locate Test Call in Skype for Business Log

A strategy to find the test call quickly is to search the log backwards for the string “INVITE sip” which corresponds to the initial SIP message associated with the call as shown in the extract below.

```
TL_INFO(TF_PROTOCOL) [0]08B8.11C4::12/13/2011-22:14:16.164.0000bab2  
(SIPStack,SIPAdminLog::TraceProtocolRecord:SIPAdminLog.cpp(125))$$begin_  
record
```

```
Trace-Correlation-Id: 1066643171
```

```
Instance-Id: 000010F8
```

```
Direction: outgoing
```

```
Peer: 10.133.11.71:1081
```

```
Message-Type: request
```

```
Start-Line: INVITEsip:10.133.11.71:1081;transport=tls;ms-  
opaque=f265f30ed4;ms-received-cid=FB00;grid SIP/2.0
```

```
From: <sip:ocs_  
client3@planolab.audiocodes.com>;tag=79882da9cf;epid=518fe1de1d
```

```
To: <sip:ocs_  
client2@planolab.audiocodes.com>;epid=ad43a533af;tag=e63e42b63f
```

```
CSeq: 3 INVITE
```

Call-ID: 3c5eed8dfdc748729bd72ad2c64bf510

... (removed text here)

o=- 0 0 IN IP4 10.133.11.73

s=session

c=IN IP4 10.133.11.73

b=CT:99980

t=0 0

m=audio 1462 RTP/SAVP 114 9 112 111 0 8 116 115 4 97 13 118 101

a=ice-ufrag:E385

a=ice-pwd:x7t5lzxDgQExybbhBdRG1H0F

a=candidate:1 1 UDP 2130706431 10.133.11.73 1462 typ host

a=candidate:1 2 UDP 2130705918 10.133.11.73 1463 typ host

a=crypto:2AES\_CM\_128\_HMAC\_SHA1\_80  
inline:94jUldYJL2x94mTvmABNbD1cjkywrN77mP4JL1T|2^31|1:1

a=remote-candidates:1 10.133.11.71 26064 2 10.133.11.71 26065

... (removed text here)



It is possible that the media information shown in the INVITE message (above) is modified in a later message exchange. If this is the case, further analysis is required.

## Compare Call Information with Sniffer Trace

Open the captured sniffer file and search for data to/from the media ports identified in the Skype for Business log.

Figure 12-4: Sniffer Trace

No.	Time	Source	Destination	Protocol	Length	Info
485	9.200563	10.133.11.71	10.133.11.73	STUN	146	Binding Request user: E3851//2
537	9.229705	10.133.11.71	10.133.11.73	CLASSIC-S	86	Message: Binding Request
540	9.280358	10.133.11.71	10.133.11.73	STUN	146	Binding Request user: E3851//2
541	9.280429	10.133.11.71	10.133.11.73	STUN	146	Binding Request user: E3851//2
542	9.306160	10.133.11.73	10.133.11.71	STUN	130	Binding Success Response XOR-MAPPED-ADDRESS: 10.133.11.71:26064 user: E3851//2
554	9.331301	10.133.11.71	10.133.11.73	STUN	146	Binding Request user: E3851//2
558	9.355431	10.133.11.73	10.133.11.71	STUN	130	Binding Success Response XOR-MAPPED-ADDRESS: 10.133.11.71:26065 user: E3851//2
559	9.355528	10.133.11.73	10.133.11.71	STUN	146	Binding Request user: I//2:E385
560	9.355572	10.133.11.73	10.133.11.71	STUN	146	Binding Request user: I//2:E385
561	9.381954	10.133.11.71	10.133.11.73	STUN	130	Binding Success Response XOR-MAPPED-ADDRESS: 10.133.11.73:1462 user: I//2:E385
562	9.382162	10.133.11.71	10.133.11.73	STUN	130	Binding Success Response XOR-MAPPED-ADDRESS: 10.133.11.73:1463 user: I//2:E385
859	13.852980	10.133.11.73	10.133.11.71	CLASSIC-S	86	Message: Binding Request
861	13.911661	10.133.11.73	10.133.11.71	STUN	150	Binding Request user: I//2:E385
862	13.911751	10.133.11.73	10.133.11.71	STUN	150	Binding Request user: I//2:E385
863	13.932921	10.133.11.71	10.133.11.73	STUN	130	Binding Success Response XOR-MAPPED-ADDRESS: 10.133.11.73:1462 user: I//2:E385
864	13.933108	10.133.11.71	10.133.11.73	STUN	130	Binding Success Response XOR-MAPPED-ADDRESS: 10.133.11.73:1463 user: I//2:E385
870	14.093031	10.133.11.71	10.133.11.73	UDP	85	Source port: 26065 Destination port: nucleus
871	14.093103	10.133.11.71	10.133.11.73	UDP	197	Source port: 26065 Destination port: nucleus
902	15.322599	10.133.11.71	10.133.11.73	UDP	85	Source port: 26065 Destination port: nucleus
903	15.322701	10.133.11.71	10.133.11.73	UDP	217	Source port: 26065 Destination port: nucleus
925	17.521083	10.133.11.73	10.133.11.71	UDP	85	Source port: nucleus Destination port: 26065
926	17.521114	10.133.11.73	10.133.11.71	UDP	233	Source port: nucleus Destination port: 26065
928	17.878241	10.133.11.71	10.133.11.73	UDP	85	Source port: 26065 Destination port: nucleus
929	17.878440	10.133.11.71	10.133.11.73	UDP	217	Source port: 26065 Destination port: nucleus
932	18.081266	10.133.11.71	10.133.11.73	UDP	85	Source port: 26065 Destination port: nucleus
933	18.081358	10.133.11.71	10.133.11.73	UDP	217	Source port: 26065 Destination port: nucleus
936	18.284338	10.133.11.71	10.133.11.73	UDP	85	Source port: 26065 Destination port: nucleus
937	18.284442	10.133.11.71	10.133.11.73	UDP	217	Source port: 26065 Destination port: nucleus
939	18.593041	10.133.11.71	10.133.11.73	UDP	45	Source port: 26065 Destination port: nucleus
940	18.593148	10.133.11.71	10.133.11.73	UDP	217	Source port: 26065 Destination port: nucleus

## Determine Whether SmartTAP will Record this Call

If there is a correlation between the call information gathered from the Skype for Business protocol log and the sniffer data collected for the recording NIC interface (or switch port forwarding the mirrored traffic), the call meets the SmartTAP recording requirements for Skype for Business.

## Troubleshooting Skype for Business Plugin Installation

This section describes the troubleshooting options when the Skype for Business installation plugin fails.

### Enable the Browser Service

The Enable the Browser Service service automatically stops if your registry settings are not configured to maintain the browse list.

#### ➤ To verify your settings:

1. Navigate to Start > Run
2. Type regedit and click Enter

3. Navigate to HKEY\_LOCAL\_MACHINE\SYSTEM\CurrentControlSet\Services\Browser\Parameters

The MaintainServerList value should be set to Yes or Auto

- If this Value is set to No the computer browser service will not start.

## Use “net view” to Verify

Normally you do NOT have to enable “net view” service to run the install; however, sometimes it makes a difference. The reason why entering user credentials sometimes does not work is that the Front End can’t see the domain in order to authenticate the user.

A simple test is to run “net view” from the command line. If the command returns a list of servers like is shown in the example below, the install should work. If not, then this indicates that there is a problem with the machine (because it can’t currently see the domain).

```
C:\Users\Administrator.QALABEE>net view
Server Name      Remark
-----
\\BE
\\EDGE
\\FE1
\\OCS-CLIENT3
\\OCSCCLIENT1
\\QA-USER2
\\SmartTAP 360° Live
The command completed successfully.
```

## Troubleshoot Skype for Business Recording

This section describes troubleshooting for Skype for Business Recording.

### No Records for the Calls

When there are no records for calls, verify the following:

- Make sure the firewall is open for in traffic on port 9901, for out traffic to 9090 on the plugin machine. Also, open for in traffic on port 9090 and out traffic to port 9901 on SmartTAP 360° Live machine.
- If there are messages in the Skype for Business plugin logs stating “no SIP messages are seen”, check for errors and exception in the log files.
- If the Skype for Business plugin failed to register to the Front End, recheck with the customer if the pool name that was provided during Skype for Business plugin installation is correct.

- When the Skype for Business plugin is installed on SBA machine, plugin fails to register to FE until the SBA synchronizes with the main FE. It may take 30 minutes or more. It might need to restart the Skype for Business plugin to trigger registration again.

### Calls with No Audio

Run Wireshark to capture the tapping interface and make a call. Make sure there are UDP packets in Wireshark and if decoded as RTP they appear as RTP instead of RTP unknown version.

### Enabling Promiscuous Mode on VMWare ESXi

- Using the vSphere client, promiscuous mode needs to be enabled in the following locations:
- Configuration -> Networking->Properties (on the applicable vSwitch) ->
  - In the Ports tab, vSwitch Configuration, click edit > Policy Exceptions -> Promiscuous Mode > Change to Accept
  - In the Ports tab, VM Network (applicable network name), click edit > Security > Promiscuous Mode > Change to Accept

## 13 Configure Microsoft SNMP Service

The SmartTAP 360° Live system optionally uses the Microsoft SNMP agent for configuration and alarms. All Windows servers that are part of a SmartTAP 360° Live installation can have the SNMP feature enabled and configured. This service must be configured on the following servers:

- SmartTAP Communication Server Installation
- SmartTAP Media Server Installation
- SmartTAP Call Delivery Server Installation

The service must be configured for the SmartTAP Storage Server Installation if different from the SmartTAP server for storage statistics and on the servers in branches for system health presentation.



- SNMP Trap Service must be disabled on SmartTAP servers running the Application Server component.
- For each SmartTAP software component, it is only necessary to setup the SNMP service once per server.
- For Call Delivery Server Installation, additional manual configuration is required (see Section [Installing the Call Delivery Service](#) on page 29).

You can install Microsoft SNMP Agent using one of the following methods:

- Automatic
- Manual

### Automatic SNMP Setup

Starting from SmartTAP Version 2.2, there is an automated installer for setting up SNMP on a system. If a system does not have SNMP services installed, this is a simple and easy way to setup SNMP without performing the manual procedure described in Section [Configure Microsoft SNMP Service](#) above.

By default, the installer is located within the install package as is not installed to the local drive with the SmartTAP installer.

#### ➤ Do the following:

1. In your SmartTAP distribution directory, locate the following file in either of the following locations:
  - `.\Program Files\AUDIOCODES\SmartTAP\Install\EnableSNMPOnServer.bat`
  - `.\installation suite\tools\EnableSNMPOnServer.bat`
2. Right-click and choose "Run as administrator".

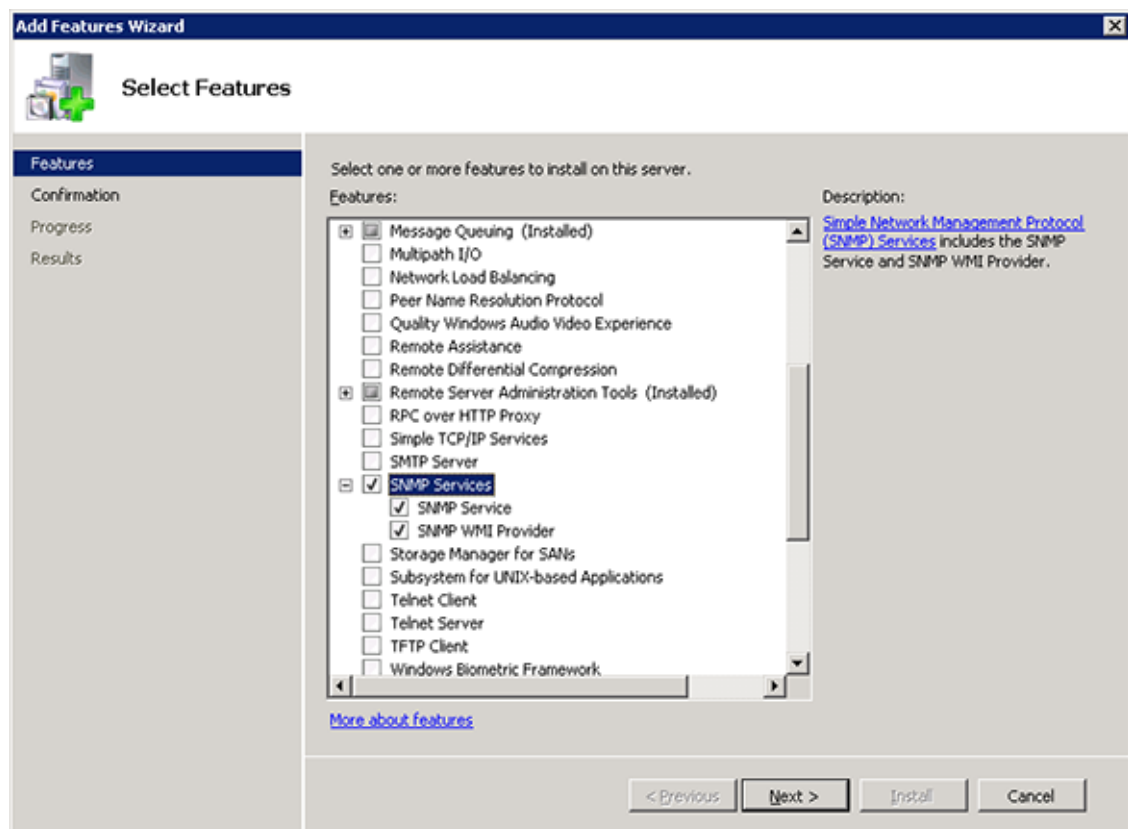
## Manual SNMP Setup

The procedure below describes how to install the SNMP Server feature.

➤ **Do the following:**

1. Open Turn on Windows features on or off (Control Panel > Programs and Features > Turn on Windows features on or off).
2. Click **Features**, and click **Add Features**.
3. Select **SNMP Services**.

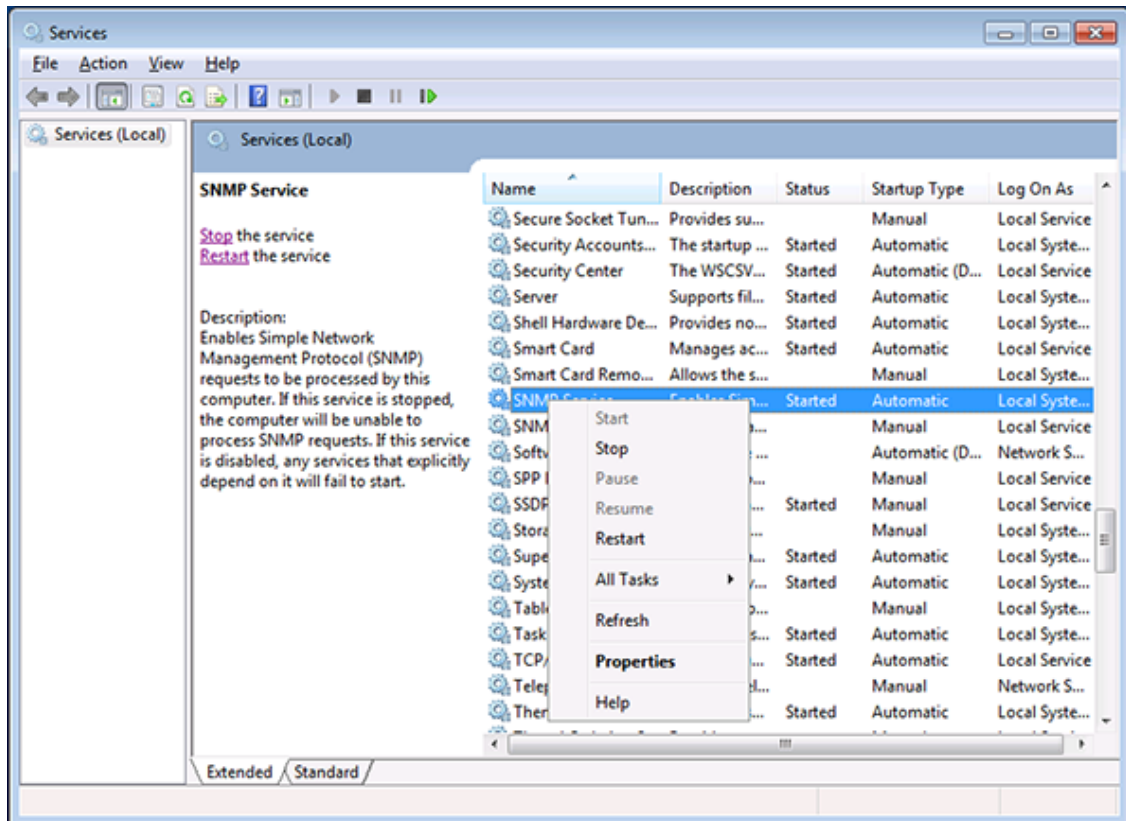
Figure 13-1: Add Features Wizard



4. Open Services (**Start** > **Run...** > **services.msc**).
5. Right click over the SNMP Service listing.

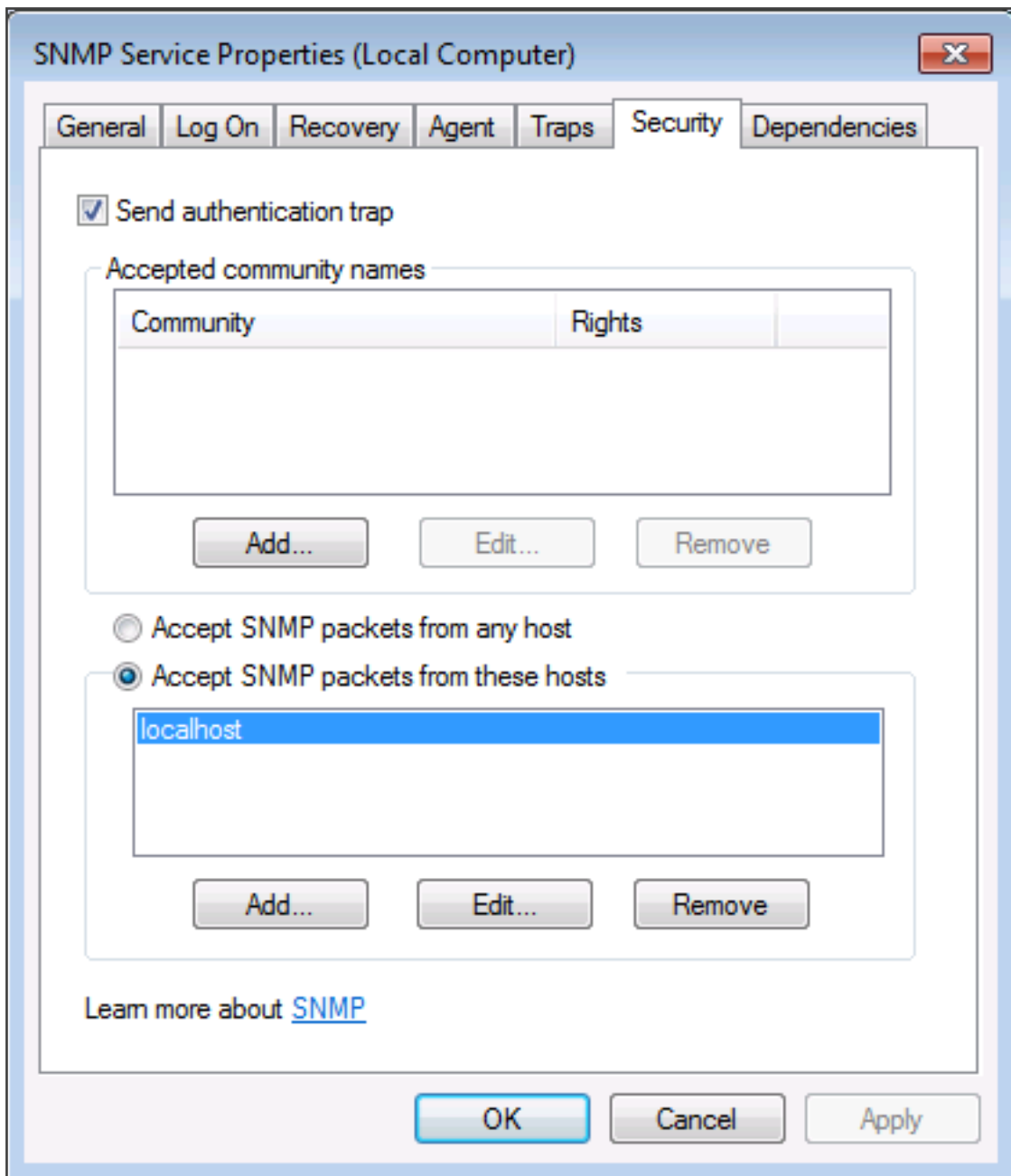


Figure 13-2: SNMP Service



6. Select **Properties** > **Security**; the following screen appears:

Figure 13-3: SNMP Service Properties

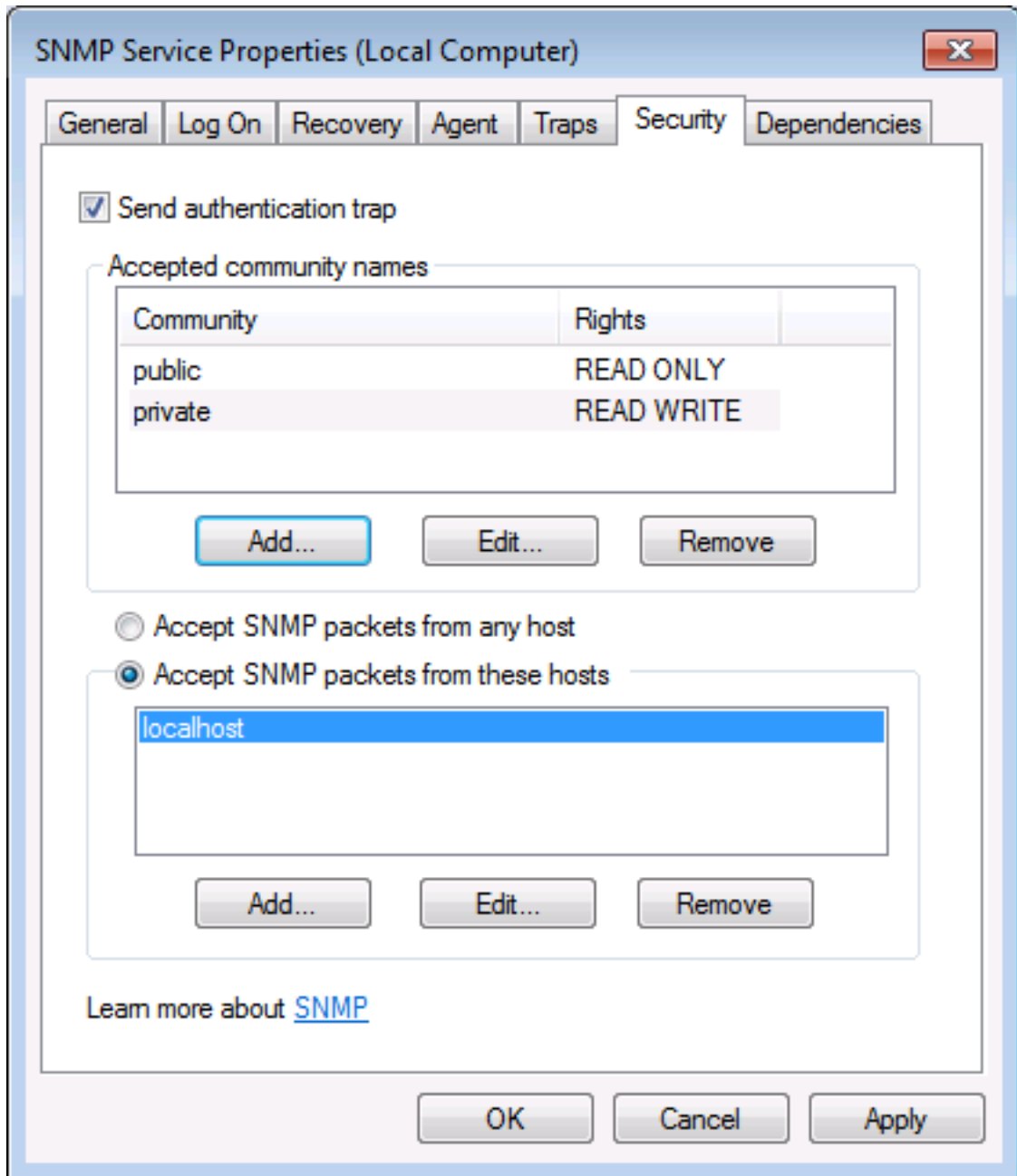


7. In the Accepted community names window, add the following;
  - public Community with READ ONLY rights
  - private Community with READ WRITE rights



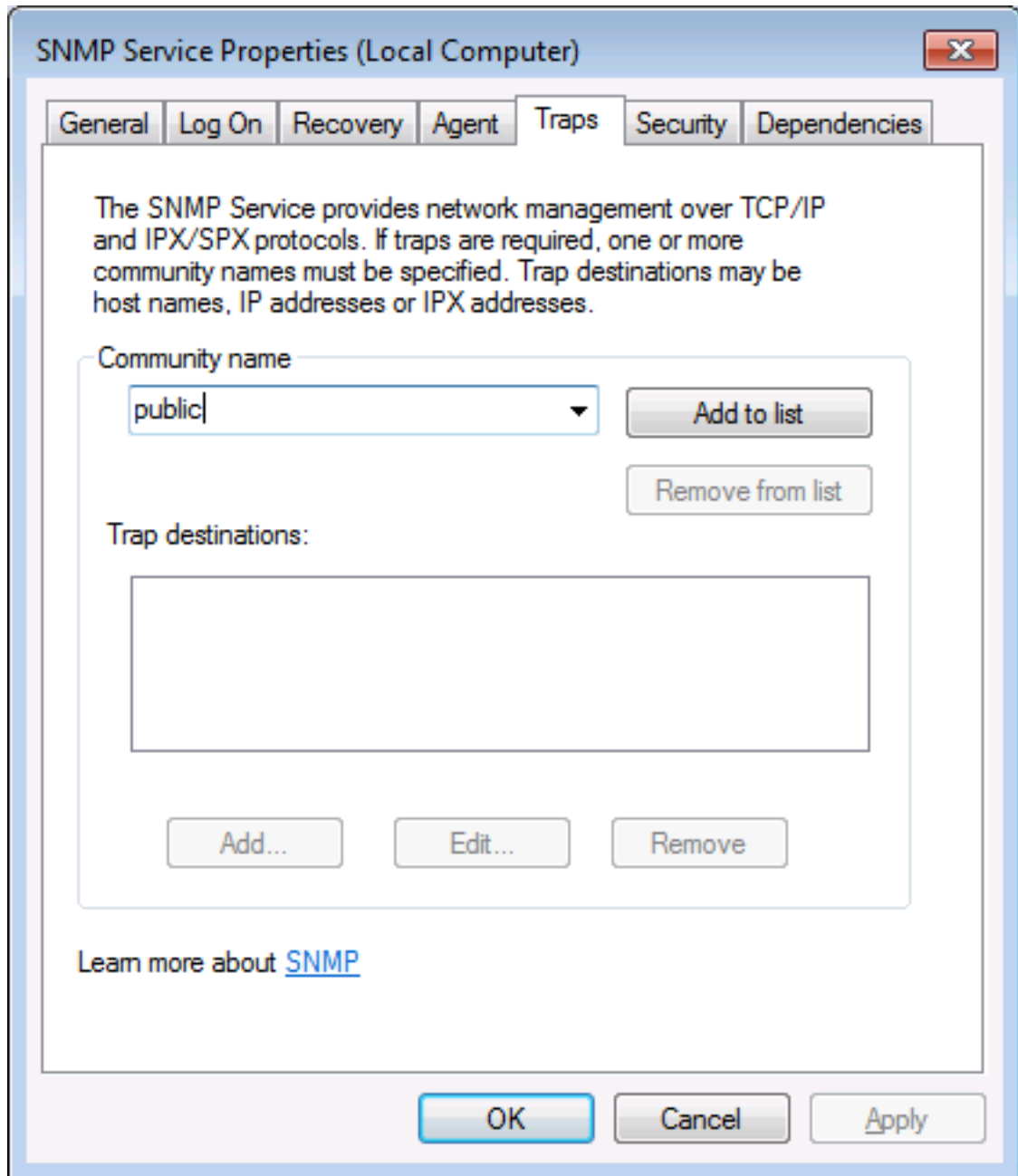
The community names must be in lower case.

Figure 13-4: SNMP Service Properties - Security



8. In the Accept SNMP packets from these hosts window, click Add... to add the following:
  - If this is a standalone SmartTAP server, leave localhost as the only entry
  - If this is for a SmartTAP installation that involves more than one server, add the IP address of the Application Server (AS) instead
9. Click **Apply**.
10. Select the **Traps** tab.
11. From the 'Community name' drop-down list, select **public**.
12. Click **Add to list**.

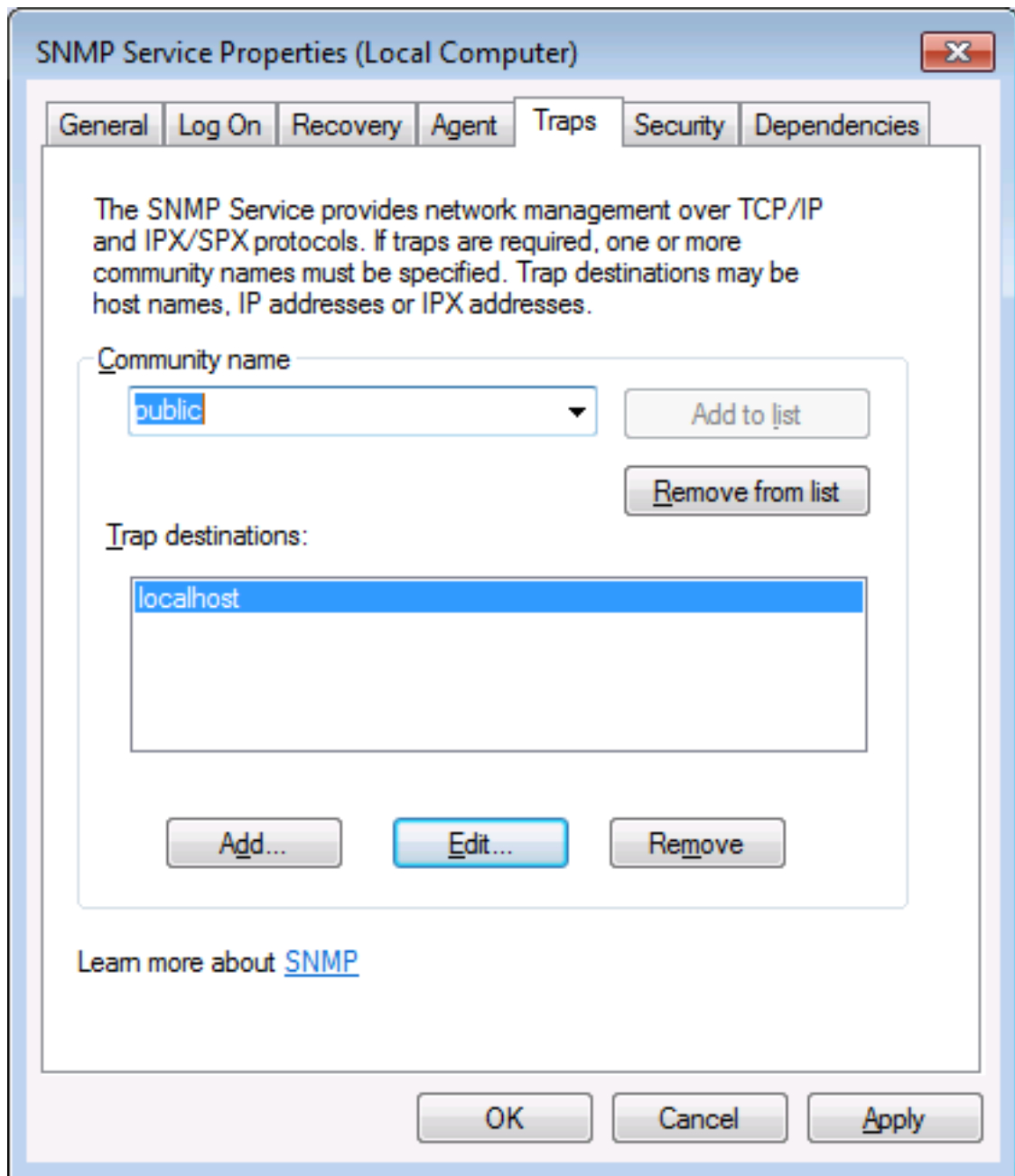
Figure 13-5: SNMP Service Properties - Traps



13. Click Add... to add Trap destinations as follows:

- If this is a standalone server enter localhost
- If this is for a SmartTAP installation that involves more than one server add the IP address of the Application Server (AS) instead

Figure 13-6: SNMP Service Properties – Traps – Add Trap Destinations



14. Click OK.

### **International Headquarters**

1 Hayarden Street,

Airport City

Lod 7019900, Israel

Tel: +972-3-976-4000

Fax: +972-3-976-4040

### **AudioCodes Inc.**

200 Cottontail Lane

Suite A101E

Somerset NJ 08873

Tel: +1-732-469-0880

Fax: +1-732-469-2298

**Contact us:** <https://www.audiocodes.com/corporate/offices-worldwide>

**Website:** <https://www.audiocodes.com/>

**Documentation Feedback:** <https://online.audiocodes.com/documentation-feedback>

©2021 AudioCodes Ltd. All rights reserved. AudioCodes, AC, HD VoIP, HD VoIP Sounds Better, IPmedia, Mediant, MediaPack, What's Inside Matters, OSN, SmartTAP, User Management Pack, VMAS, VoIPerfect, VoIPerfectHD, Your Gateway To VoIP, 3GX, VocaNom, AudioCodes One Voice, AudioCodes Meeting Insights, AudioCodes Room Experience and CloudBond are trademarks or registered trademarks of AudioCodes Limited. All other products or trademarks are property of their respective owners. Product specifications are subject to change without notice.

Document #: LTRT-27197

